

CDP-307ESD/950

SERVICE MANUAL

US Mode

E Mode

CDP-307ES

US Mode

Canadian Mode

AEP Mode

CDP-95

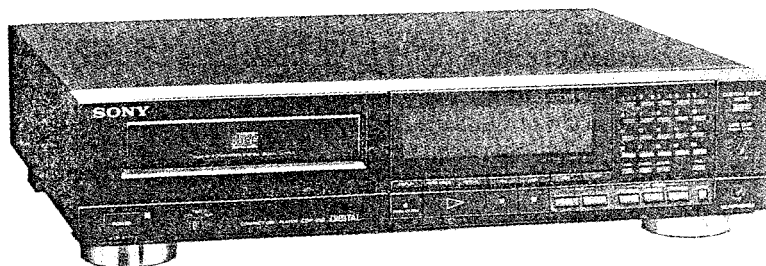

Photo: CDP-950

SPECIFICATIONS

Compact disc player

System	Compact disc digital audio system
Disc	Compact disc
Laser	Semiconductor laser ($\lambda = 780 \text{ nm}$)
Emission duration	Continuous
Laser output	Less than 44.6 μW * This output is the value measured at a distance of 200 mm from the objective lens surface on the Optical Pick-up Block.
Frequency response	2 - 20,000 Hz $\pm 0.3\text{dB}$
Signal to noise ratio	More than 104 dB
Dynamic range	More than 95 dB
Harmonic distortion	Less than 0.003% (1 kHz)
Channel separation	More than 95 dB (1 kHz)
Wow and flutter	Below measurable limit

Outputs jacks

LINEOUT (FIXED) (phono jacks)	Output level 2V (at 50 kilohms) Load impedance over 10 kilohms
LINEOUT (VARIABLE) (phono jacks)	Output level max. 2 V (at 50 kilohms) Load impedance over 50 kilohms
HEADPHONES (stereo phone jack)	Output level max. 15 mW Load impedance 32 ohms
DIGITAL OUT (COAXIAL) (phono jacks)	Output level 0.5Vp-p (at 75 ohms) Load impedance 75 ohms (CDP-950: Canadian, AEP model) (CDP-307ESD)

Disc

Track pitch	1.6 μm
Sampling frequency	44.1 kHz
Quantization	16 bit linear quantizing/channel
Modulation system	EFM
Transfer rate	2.03 Mbit/sec. (before modulation)

General

Power requirements	US, Canadian model: 120V AC, 60 Hz AEP model: 220V AC, 50/60Hz E model: 110, 120, 220, 240 V AC, 50/60Hz
Power consumption	13 W
Dimensions	Approx. 430 x 105 x 340 mm (w/h/d) (17 x 4 ¹ / ₄ x 13 ¹ / ₂ inches)
Weight	Approx. 5.6 kg (12 lb 6 oz), net

Supplied accessories

Remote commander (1)
Audio signal connecting cord (1)
Sony SUM-3 (NS) batteries (2)

Remote commander (RM - D650)

Remote control system	Infrared control
Power requirements	3V DC with two size AA (R6) batteries
Dimensions	Approx. 62 x 20 x 168.5 mm (w/h/d) (2 ¹ / ₂ x 1 ³ / ₁₆ x 6 ³ / ₄ inches)
Weight	Approx. 130 g (5 oz) incl. batteries



COMPACT DISC PLAYER SONY



TABLE OF CONTENTS

<u>Title</u>	<u>Description</u>	<u>Page</u>
	Specifications	1
	Model Identification	3
	Safety Checkout	3
	Servicing Note	4
	Location of Controls	6
	Playing in the Desired Order	8
	Playing in a Random Order	9
	Playing Repeatedly	10
	On Custom Files	10
	Writing a Comment about a Disc	11
	Keeping the Program in Memory	12
	Giving a Disc Indexes as You Want	13
SECTION 1.	ELECTRICAL ADJUSTMENT	15
	IC Block Diagram	18
SECTION 2.	DIAGRAMS	
	PC Board Location	20
	Semiconductor Lead Layouts	20
	Printed Wiring Boards.	21
SECTION 3.	EXPLODED VIEWS AND PARTS LIST	25
SECTION 4.	ELECTRICAL PARTS LIST	29

SAFETY-RELATED COMPONENT WARNING!!

COMPONENTS IDENTIFIED BY SHADING AND MARK  ON THE SCHEMATIC DIAGRAMS AND IN THE PARTS LIST ARE CRITICAL TO SAFE OPERATION. REPLACE THESE COMPONENTS WITH SONY PARTS WHOSE PART NUMBERS APPEAR AS SHOWN IN THIS MANUAL OR IN SUPPLEMENTS PUBLISHED BY SONY.

ATTENTION AU COMPOSANT AYANT RAPPORT À LA SÉCURITÉ!

LES COMPOSANTS IDENTIFIÉS PAR UNE TRAME ET UNE MARQUE  SUR LES DIAGRAMMES SCHÉMATIQUES ET LA LISTE DES PIÈCES SONT CRITIQUES POUR LA SÉCURITÉ DE FONCTIONNEMENT. NE REMPLACER CES COMPOSANTS QUE PAR DES PIÈCES SONY DONT LES NUMÉROS SONT DONNÉS DANS CE MANUEL OU DANS LES SUPPLÉMENTS PUBLIÉS PAR SONY.

MODEL IDENTIFICATION

— Specification Labels —

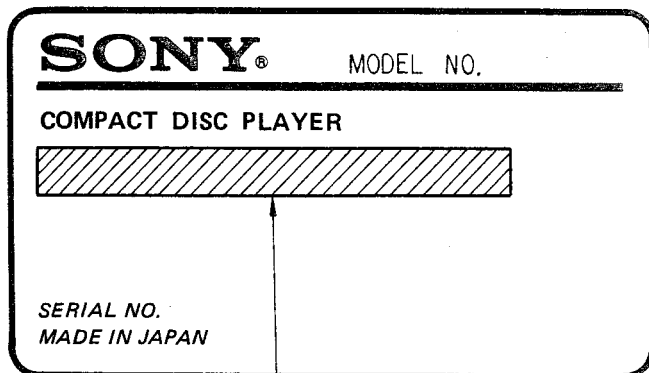

US, Canadian model: AC: 120V 60Hz 13W
 AEP model: AC: 220V~50/60Hz 13W
 E model: AC: 110, 120, 220, 240V~50/60Hz 13W

SAFETY CHECK-OUT

After correcting the original service problem, perform the following safety check before releasing the set to the customer:

Check the antenna terminals, metal trim, "metallized" knobs, screws, and all other exposed metal parts for AC leakage. Check leakage as described below.

LEAKAGE TEST

The AC leakage from any exposed metal part to earth ground and from all exposed metal parts to any exposed metal part having a return to chassis, must not exceed 0.5 mA (500 microamperes). Leakage current can be measured by any one of three methods.

1. A commercial leakage tester, such as the Simpson 229 or RCA WT-540A. Follow the manufacturers' instructions to use these instruments.
2. A battery-operated AC milliammeter. The Data Precision 245 digital multimeter is suitable for this job.
3. Measuring the voltage drop across a resistor by means of a VOM or battery-operated AC voltmeter. The "limit" indication is 0.75 V, so analog meters must have an accurate low-voltage scale. The Simpson 250 and Sanwa SH-63Trd are examples of a passive VOM that is suitable. Nearly all battery operated digital multimeters that have a 2 V AC range are suitable. (See Fig. A)

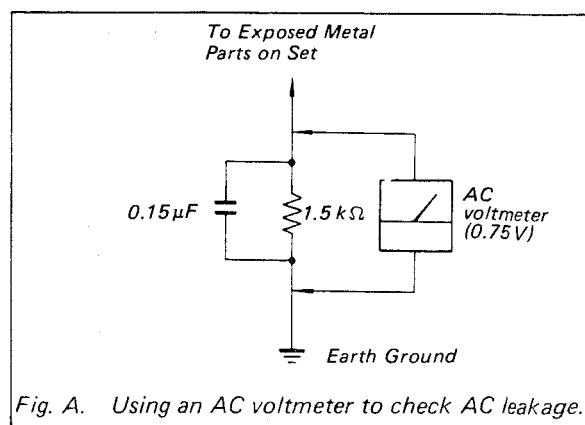

Fig. A. Using an AC voltmeter to check AC leakage.

— SERVICING NOTE —

PROTECTION OF EYES FROM LASER BEAM DURING SERVICING

This set employs a laser. Therefore, be sure to follow carefully the instructions below when servicing.

CAUTION

Use of controls or adjustments or performance of procedures other than those specified herein may result in hazardous radiation exposure.

1. Laser Diode Properties

- Material: GaAlAs
- Wavelength: 780 nm
- Emission Duration: continuous
- Laser Output: max. 44.6 μ W*

* This output is the value measured at a distance of about 200 mm from the objective lens surface on the Optical Pick-up Block.

2. During service, do not take the Optical Pick-up Block apart, and do not adjust the APC circuit. If there is a breakdown in the APC circuit (including laser diode), replace the entire Optical Pick-up Block (including APC board).

BESKYTTELSE AF ØJNE MOD LASERSTRÅLING UNDER SERVICE

I dette apparat anvendes laserlys. Derfor skal nedenstående instruktioner nøje følges under service.

Følg iverigt instruktionerne i servicemanualen.

ADVARSEL!!

Under service må øjnene ikke komme nær objektiv-linsen på den optiske pick-up enhed. I tilfælde af at det er nødvendigt at kontrollere udsendelsen af laserlys, skal det ske i en afstand af mere end 25 cm fra den optiske pick-up.

1. Laser-dioe data

- Materiale: GaAlAs
- Bølgelængde: 780 nm
- Udstråling: Kontinuerlig
- Laseroutput: Max. 0,4 mW*
- * Målt i 1,6 mm afstand fra overfladen af objektiv-linsen på den optiske pick-up enhed.
- Klassifikation: Klasse IIIb.

2. Adskil aldrig den optiske pick-up enhed under service, og juster ikke APC kredsløbet (Automatic Power Control). Hvis APC kredsløbet (incl. laser-dioden) bryder ned, skal hele den optiske pick-up enhed (incl. APC printkortet) udskiftes.

LASER ADVARSEL MÆRKNING

Følgende mærkning findes indvendig i apparatet:

1. Advarsel Mærkning

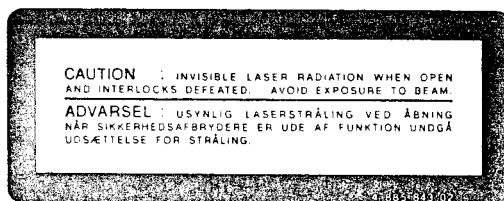

VAROITUS: Laitte sisältää, laseriodin, joka lähettää (näkyvätöntä) silmille vaarallista lasersäteilyä.

HOW TO OPEN THE DISC TRAY WHEN POWER SWITCH TURNS OFF

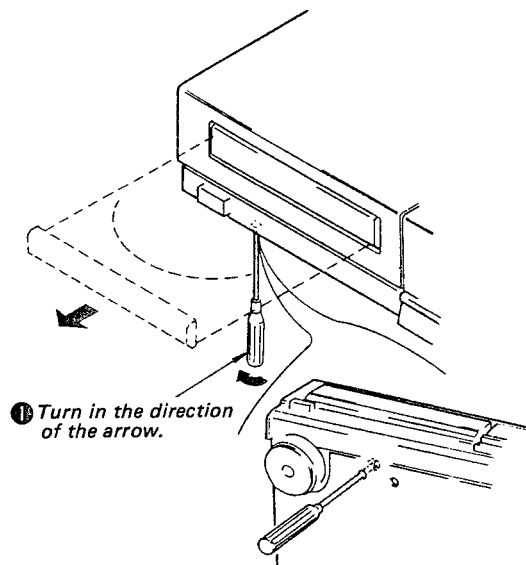

Caution: When you work, keep the set horizontal.

DISC TRAY REMOVAL

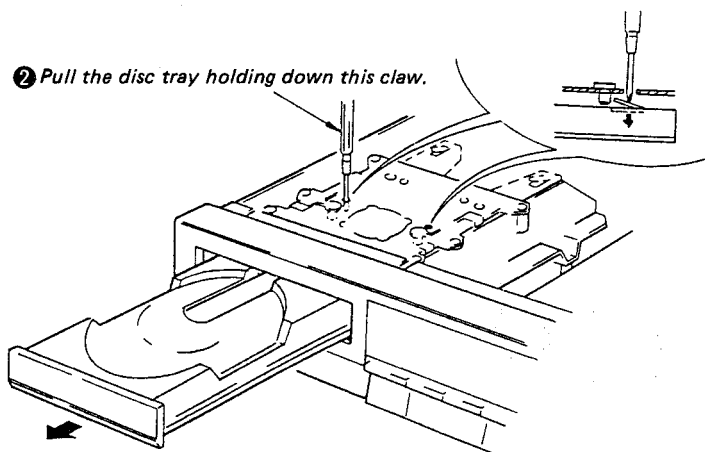

NOTES ON HANDLING THE OPTICAL PICK-UP BLOCK OR BASE UNIT

The laser diode in the optical pick-up block may suffer electrostatic breakdown because of the potential difference generated by the charged electrostatic load, etc. on clothing and the human body. During repair, pay attention to electrostatic breakdown and also use the procedure in the printed matter which is included in the repair parts. The flexible board is easily damaged and should be handled with care.

NOTES ON LASER DIODE EMISSION CHECK

The laser beam on this model is concentrated so as to be focused on the disc reflective surface by the objective lens in the optical pick-up block. Therefore, when checking the laser diode emission, observe from more than 30 cm away from the objective lens.

LASER DIODE AND FOCUS SEARCH OPERATION CHECK

1. Make POWER switch on with no disc inserted and disc table closed.
2. Confirm that the following operation is performed while observing the objecting lens.

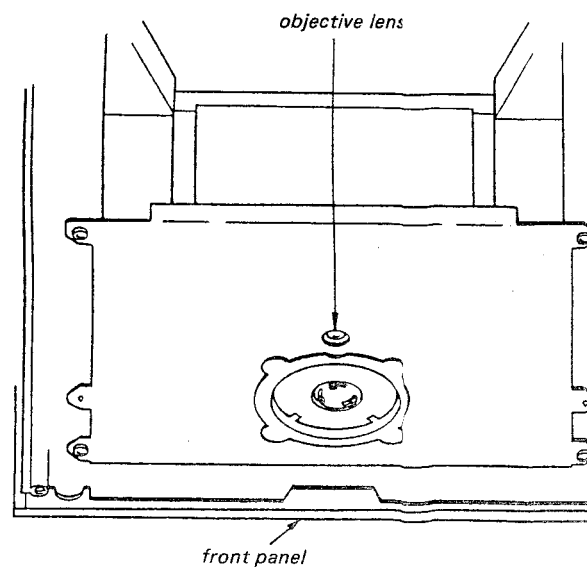

- ① Confirm that laser beam is spread.
- ② Up and down motion of the objective lens. (3 times)

Location of Controls

Front Panel

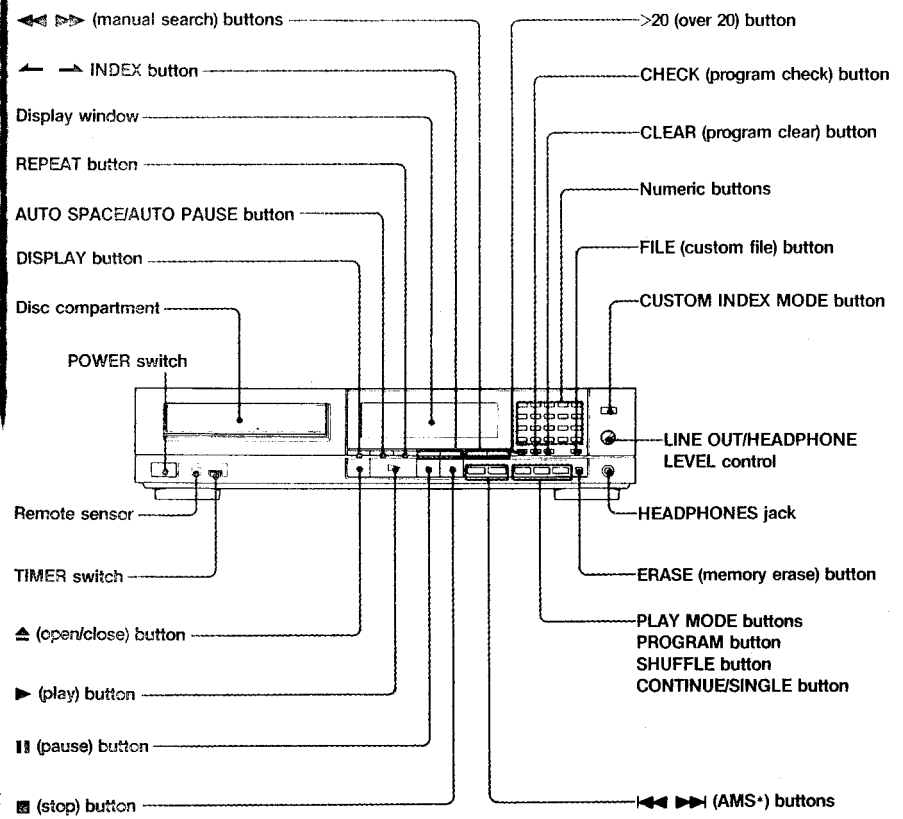

Remote Commander

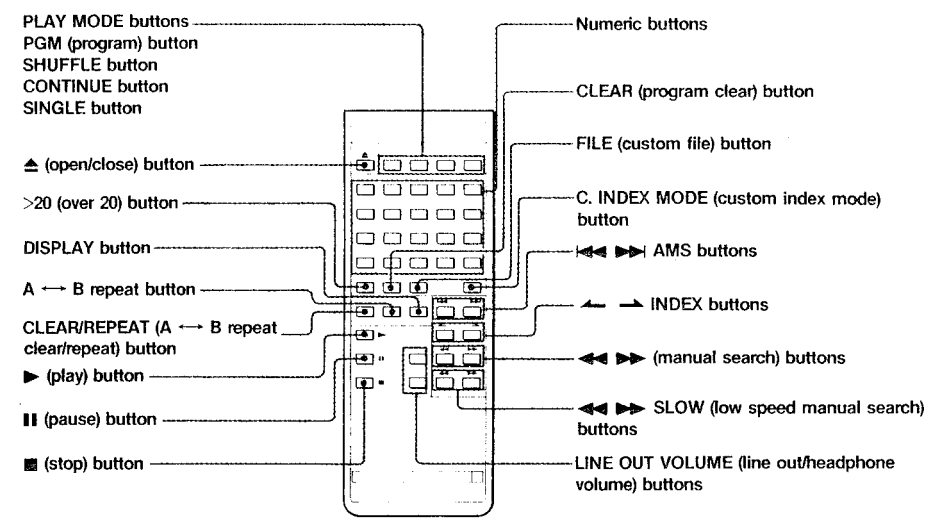

Remote Control Operation

Once the POWER switch is turned on, you can remotely control various functions of the player with the supplied remote commander.

- Operations which is performed only with the remote commander**
- Manual search at low speed
 - A ↔ B repeat

- Operations which cannot be performed with the remote commander**
- Turning the power on and off
 - Setting and releasing auto pause function
 - Setting and releasing auto space function
 - Checking the programmed selections
 - Writing a comment about a disc (disc memo function)
 - Clearing custom indexes
 - Clearing all custom files
 - Timer activated play

* AMS is an abbreviation of Automatic Music Sensor.

- Notes on the remote commander and remote control operation**
- Keep the commander away from extremely hot or humid places.
 - Avoid dropping any foreign objects into the commander casing, particularly when replacing the batteries.
 - To avoid a malfunction, do not simultaneously depress two or more buttons.
 - Avoid exposure of the remote sensor to direct sunlight or lighting apparatus. Such exposure can cause a malfunction.

Description of the Rear Panel

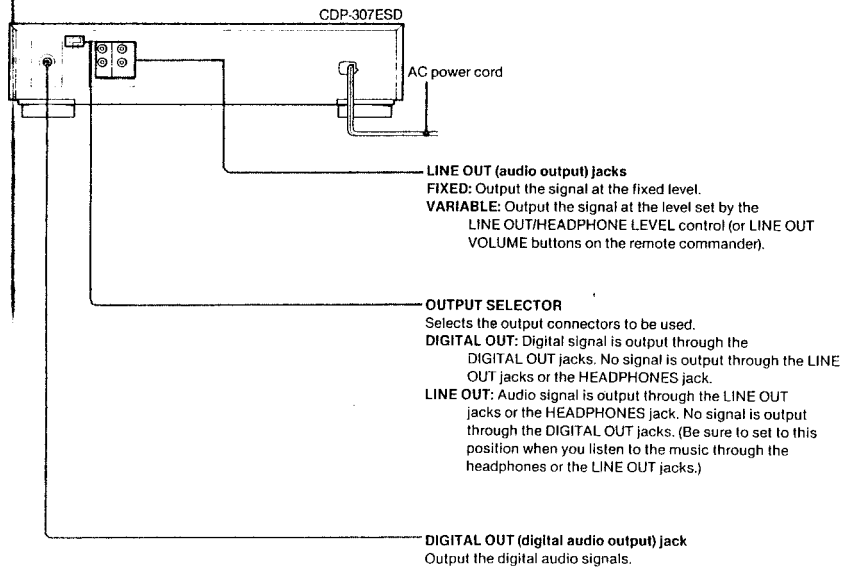

Note

If the LINE OUT/HEADPHONE LEVEL control is turned while recording through the VARIABLE LINE OUT jacks, the level of the recorded sound will be different from that set by the recording level controls of the tape deck.

Playing in the Desired Order—Program Play

You can play up to 20 selections in the desired order.

Programming Selections Directly

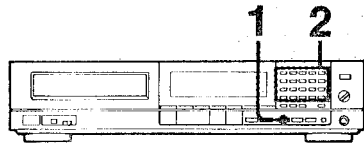

- 1 Press PROGRAM.
- 2 Press the numeric buttons for the desired selection in the order to be programmed.

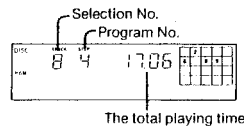

To play the programmed selections
Press ►.

Adding selections to a program during program play

Press the numeric buttons during play. You can add selections up to 20.

- Pause cannot be programmed during play.

When each selection ends during program play

That selection number disappears from the display, but the program itself remains. If you press ►, you can play the same program again.

Note

If you press PROGRAM during the continuous play, single play or shuffle play (page 9), the selection currently being played is programmed as the first selection in the program.

Program is cleared in the following cases

- **PAUSE** is pressed twice during program play.
- CONTINUE/SINGLE, SHUFFLE or **STOP** is pressed.

Space between selections during program play

There is a blank of 1 second between each programmed selection. However, when consecutive selections (e.g. 4th → 5th) are programmed, the space on the disc is inserted as it is.

To record program play on a tape, use the auto space function so that a blank of 3 seconds is inserted between selections.

What is this indication?

"----" indication appears on the display window instead of the numbers, if a selection numbered 21 or higher is programmed or the total playing time of the programmed selection exceeds 100 minutes.

Programming Selections while Checking the Total Programming Time (Program Edit)

This function is useful for recording, as you can adjust the total playing time to the tape duration.

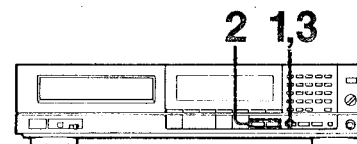

- 1 Press PROGRAM.
- 2 Choose the desired selection to be programmed with ◀◀ or ▶▶. The designated selection number blinks in the music calendar.

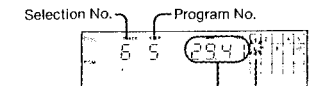

The total playing time including the selection indicated.

If the playing time of that selection is not appropriate, choose another selection.

- 3 Press PROGRAM. The designated selection is programmed and the blinking number lights up steadily.
- 4 Repeat steps 2 and 3 to program additional selections in the desired order.

To play the programmed selections

Press ►.

To program pause

During programming, press **PAUSE** at the desired point between selections. When the program reaches it, the disc stops and stands by until you press **PAUSE** again.

This function is helpful when changing the tape during recording. The total playing time will be reset to 0.00 when you press **PAUSE**.

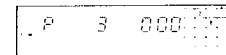

P (pause) has been programmed.
Its turn is third.

Checking the Programmed Selections

(possible only on the main unit)

Press **CHECK**.

Each time you press **CHECK**, the selections are displayed in the order they are programmed. At the last selection, "END" is displayed.

- You can check the programmed selections during play.
- Selection numbers over 20 cannot be displayed in the music calendar, but track numbers and program numbers are displayed in the window.

Clearing the Programmed Selections

Clearing the whole program

Press **■** once during stop, or twice during play. All the selections are cleared.

Clearing the last selections in the program

(operated only on the main unit)

Press **CLEAR** during stop.

The last selection is cleared each time **CLEAR** is pressed.

Clearing a specific selection

(possible only on the main unit)

1 Press **CHECK** repeatedly until the selection to be cleared is displayed.

2 Press **CLEAR** while the selection number is displayed. The selection is cleared from the program. You cannot clear the selection currently being played.

Playing in a Random Order—Shuffle Play

You can play up to 99 selections in a random order.

Playing All the Selections in a Random Order

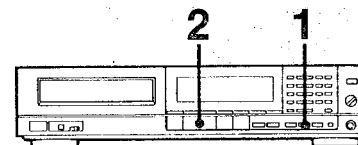

- 1 Press **SHUFFLE**.
- 2 Press **▶**. Shuffle play begins.

To cancel shuffle play mode

Press **CONTINUE/SINGLE** (or **CONTINUE** on the remote commander).

Playing Only the Desired Selections in a Random Order—Delete Shuffle Play

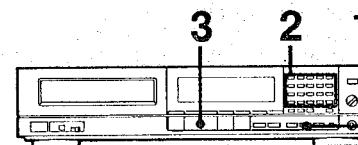

- 1 Press **SHUFFLE**.
- 2 Press the numeric buttons of the undesired selections you wish to delete. The selections disappear from the music calendar.

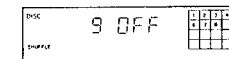

- 3 Press **▶**.

To display the remaining number of selections and time of the program

Press **DISPLAY** twice.

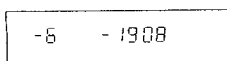

If pause is programmed, the remaining number of selections and time to the next programmed pause is displayed.

To return to the normal display, press **DISPLAY** twice, or three times (if a disc memo* is memorized).

* See page 11.

To display the next selection number and the succeeding selection number in the program

Press **DISPLAY** three times.

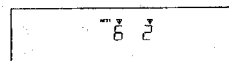

To return to the normal display, press **DISPLAY** once, or twice (if a disc memo is memorized).

What is this indication?

 This indication appears while the player is "shuffling" the selections.

If you press SHUFFLE during play

Shuffle play begins from the selection being played.

To record shuffle play

During shuffle play, a blank of one second is inserted between each selection.

To record shuffle play, use the auto space function so that a blank of 3 seconds is inserted between selections.

When delete shuffle play ends

Delete shuffle play mode is released and the player stands by in the shuffle play mode for the whole disc.

If you press the numeric buttons during shuffle play mode The selections of those numbers are also deleted, but the selection being played cannot be deleted.

To play a selection which has been deleted

Press the numeric button of that selection again. The selection number and **■** appear in the display.

Playing Repeatedly—Repeat Play

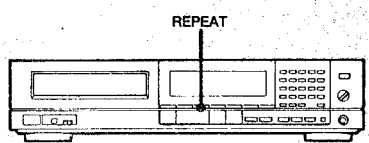

You can repeat the whole disc, a single selection, all the programmed selections, shuffle play, A ↔ B repeat play, or play between two custom indexes.

Press REPEAT during play or pause. Repeat play begins according to the current play mode.

Play mode	Selections to be repeated
Continue	All the selections
Single	The selection being played
Program	Programmed selections in the programmed order
Shuffle	All the selections, reshuffled each time

For the A ↔ B repeat play, see the description below.
For the repeat play between two custom indexes, see pages 13.

To cancel repeat play mode
Press REPEAT.

Repeating a Particular Portion (A ↔ B Repeat)

(Possible with the remote commander)
You can repeat any desired portion on a disc.

- 1 Press A ↔ B at the starting point (A) of the repeat play.
"A SET" appears in the window.
- 2 Continue playing, or press ►► or ►►► to locate the desired ending point (B).
- 3 Press A ↔ B.
"A - B REP" appears in the window, and play begins from the point A.

To cancel A ↔ B repeat
Press CLEAR/REPEAT (or REPEAT on the player).

- Going back to the point A from any point on the disc**
- 1 Press A ↔ B at the starting point (A) during play.
 - 2 Press ►► when you desire to return to the registered point. Play begins again from the point A.

A ↔ B repeat and auto pause function
If the A ↔ B repeat play is activated while the auto pause function is turned on, the player enters the pause mode each time the point A is reached. Press ■ to resume play.

To go back to the point A during A ↔ B repeat play
Press ►►.

If you press REPEAT during delete shuffle play
When the desired selections end, shuffle repeat play of all the selections starts.

On Custom Files

The CD player incorporates a memory in which you can store three types of informations called "custom files"

Three custom files you can store in memory

Disc memo	A comment of up to 10 letters, which you can assign to each individual disc. (page 11)
Program bank	A programmed playing order you store in memory for a disc, so that the disc can be played always in a fixed order. (page 12)
Custom index	Index point you can assign to anywhere you want on a disc. (page 13)

How many discs can be assigned custom files?

You can give custom files to up to 226 discs.

- A disc memo can be given to a disc which already has a program bank or custom indexes.
- A program bank and custom indexes cannot both be given to a disc at the same time.

Memory backup for the custom files

Custom files, once memorized, are retained in the compact disc player's memory for approximately 1 month without AC power supply.

What is this indication?

FILE

This indication appears when FILE is pressed while no custom file can be memorized for the disc currently put in the player. To make a custom file for the disc, clear the custom file of another disc.

To clear all custom files of a disc at once

Put the disc in the player and press ERASE. The disc memo and program bank (or the disc memo and custom indexes) are all cleared.

To clear custom files of all discs at once

Press POWER to turn on the player while keeping ERASE and FILE pressed.

Writing a Comment about a Disc

Disc Memo Function

Using the disc memo function, you can write a comment of up to 10 letters about a disc. The memo appears in the window every time you put the disc in the player. You can write one disc memo to a disc.

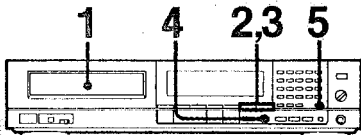

1 Put the disc in the disc compartment and press the disc compartment to close it. Make sure that the total number of selections and the total playing time is displayed. Then proceed as follows in the stop mode.

2 Press ◀ or ▶.
A blinking cursor (indicating where a letter will be written) appears.

3 Press ◀ or ▶ until the desired letter appears.
Example: If ▶ is pressed 6 times

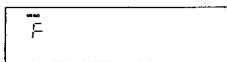

4 Press ▶ to move the cursor to the next position, and select the desired letter.



Repeat steps 3 and 4 to complete the memo.

5 Press FILE.
"FILE" appears in the window. After about 1 second, the memo you have written will be displayed.

Each time the disc is put in the compact disc player, the memo will be displayed.

Usable letters and symbols

For the disc memo, 46 letters and symbols and a space can be used. When the ◀/▶ button is pressed for the first time, the space appears. Each time ▶ is pressed, letters and symbols will

(space) A B C D E F G H I J K L M N O P Q R S T U V W X Y Z
 M O * + / | > < 9 8 7 6 5 4 3 2 1 0 -

Use ◀ to call up a previous character.

Clearing the Disc Memo

1 Put the disc whose memo you want to clear in the player.

2 Press ◀ or ▶ on the player.
The ◀/▶ button on the remote commander cannot be used.

3 Press CLEAR.

4 Press FILE.
"FILE CLR" is displayed in the window.

To rewrite letters or symbols

Before pressing FILE, move the cursor under the letter/symbol to be changed, and then select the desired letter/symbol using ◀/▶.

Where is the disc memo stored?

The disc memo is stored in the compact disc player's memory. When a disc is put in the player, the player identifies the disc by the total number of selections and the total playing time. If a disc memo has been made for that disc, the player retrieves the memo from its memory and displays it in the window. Therefore, as the disc memo is not located on the disc itself, when the disc is put in another compact disc player, no memo will be displayed.

Keeping the Program in Memory

— Program Bank Function

Memorizing a Program

After programming selections, you can keep the program memorized, so that the disc is played always in the fixed order. The memorized program is called "program bank".

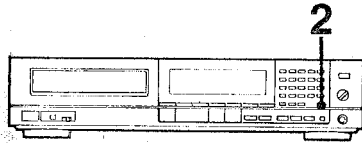

- 1 Program the selections as you want (page 8).
- 2 Press FILE.

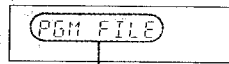

Disappears approx. one second later.

The program is memorized for the program bank.

Only one program bank can be made for a disc.

Playing the Disc Using the Program Bank

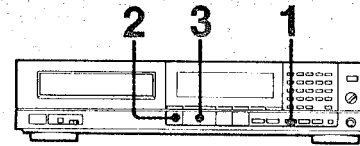

- 1 Press PROGRAM.
- 2 Press ▲ and put the disc in the disc compartment.
- 3 Press ►.

Clearing the Program Bank

- 1 Put the disc whose program bank is to be cleared in the player.
- 2 Press ■ to clear the program.
- 3 Press FILE.
"PGM CLR" is displayed, and the program bank is cleared.

Where is the program bank memorized?

The program bank is memorized in the compact disc player's memory. Therefore, if a disc for which you made a program bank is used with another compact disc player, play using the program bank is not possible.

What is this indication?

IX FILED

This indication appears when the custom index (page 13) has already been made for the disc. The program bank and the custom index cannot both be made for the same disc at the same time. To make the program bank, first clear the custom index.

To play a disc having a program bank in other modes

- 1 Set the player in the desired play mode.
- 2 Put the disc in the disc compartment.
- 3 Press ►.

If you press ▲ to close the compartment after setting the player in the continuous play mode or the single play mode, program bank play mode will be entered.

To play the selections in another program without clearing the program bank

Program the selections as you want before putting the disc in the disc compartment, or after putting the disc in the player and pressing ■. The disc will be played in the newly programmed order. You can program even during the program bank play.

Giving a Disc Indexes as You Want

— Custom Index Function

A custom index is a special index that can be assigned to any position you want on the disc. If you assign custom indexes to the positions on a disc, you can easily locate the positions during play, or enjoy repeat play between two adjacent custom indexes.

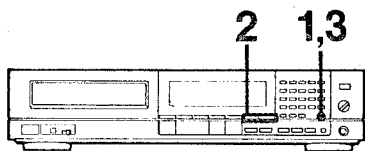

- 1 Press FILE where you want to assign a custom index during play.**
The portion for 3 seconds from the point where you pressed FILE is played repeatedly (rehearsal play).

- 2 Adjust the repeat start point using ◀◀ or ▶▶.**
Press ▶▶ to shift the repeat start point forward and ◀◀ to shift it backward. Pressing ◀◀▶▶ 7 times shifts the point by approximately 1 second.

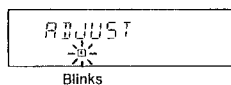

- 3 Press FILE.**
The custom index is assigned to the repeat start point.

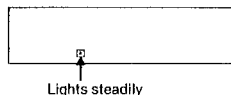

How many custom indexes can be assigned?

Up to 6 custom indexes from A to F can be assigned to a disc.

What is this indication?

This indication appears when a program bank has already been memorized for the disc. The program bank and the custom index cannot both be made for the same disc at the same time. To assign custom indexes, first clear the program bank.

PG FILED

To release rehearsal play

Press CLEAR. Normal play is resumed.

Playing from the Desired Custom Index

- 1 Press CUSTOM INDEX MODE.**
The music calendar disappears.

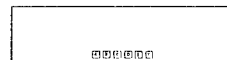

- 2 Press the desired numeric button 1 (A) through 6 (F).**
Play begins from the designated custom index. When a custom index position is passed, it disappears from the [A] - [F] display.

Clearing Custom Indexes

- 1 Press CHECK** so that the letter of the custom index you want to clear blinks.
- 2 Press CLEAR.**
Custom indexes succeeding the cleared index will be shifted ahead one position.

The custom indexes cannot be cleared during program play.

If a new custom index is assigned to a position preceding another index

Previously existing indexes will be shifted as follows.
Example: If you assign a new index between B and C.

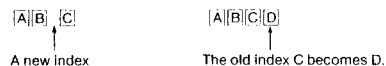

If you press FILE in the pause mode

The rehearsal play is not made and the custom index is assigned immediately at the position where FILE is pressed.

Repeating the Portion between Two Custom Indexes

During play using custom indexes, you can repeat the desired portion between any two adjacent custom indexes.

- 1 Press CUSTOM INDEX MODE** twice so that "SINGLE" is displayed in the window.
- 2 Press one of the numeric buttons 1 (A) to 6 (F)** for the starting point of the repeat play.
- 3 Press REPEAT.**

The portion between the custom index designated as the starting point and the next custom index is played repeatedly.

To cancel repeat play between custom indexes
Press REPEAT.

To change the play mode during play using custom indexes

During play using custom indexes (in other words, while the music calendar is not displayed), the play mode switches from continuous play to single play and vice versa each time CUSTOM INDEX MODE is pressed.

To release play using custom indexes

Press one of the PLAY MODE buttons (PROGRAM, SHUFFLE or CONTINUE/SINGLE). The music calendar appears.

Where are the custom indexes memorized?

The custom indexes are memorized in the compact disc player's memory. Therefore, if a disc for which custom indexes are assigned is played in other compact disc player, play using the custom indexes cannot be done.

MEMO

A series of horizontal dotted lines for writing a memo.

SECTION 1 ELECTRICAL ADJUSTMENTS

1. Perform adjustments in the order given.
2. Use YEDS-18 disc (3-702-101-01) unless otherwise indicated.
3. Use the oscilloscope with more than 10MΩ impedance.

RF PLL Frequency Adjustment

Procedure :

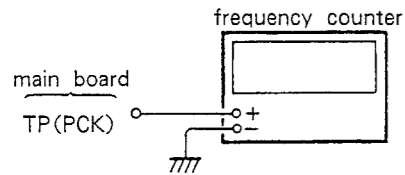

1. Connect test point TP (ASY) to ground with jumper wire.
2. Turn POWER switch on.
3. Connect the frequency counter to test point TP(PCK).
4. Adjust RV201 so that the reading on frequency counter is 4.3218MHz±30kHz.
5. Remove lead wire connecting TP(ASY) and ground.
6. Put disc (YEDS-18) in and press ▷ button.
7. Confirm that the reading on frequency counter is 4.3218MHz.

Adjustment Location : main board

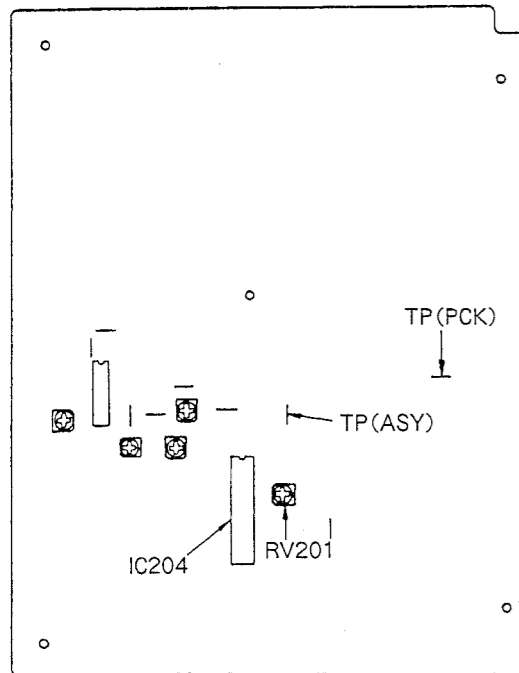

E-F Balance Adjustment

This adjustment should be made when replacing Optical Pick-up Block.

Procedure :

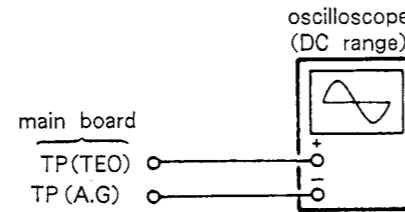

1. Connect test points TP (ADJ) and TP (TE I) to ground with jumper wires.
2. Connect oscilloscope to test points TP(TEO) and TP (A. G).
3. Turn POWER switch on.
4. Put disc (YEDS-18) in and playback the 6th selection.
5. Adjust RV101 so that the oscilloscope waveform is symmetrical on the top and bottom in relation to 0V.

Note: Take sweep time as long as possible to obtain best waveform.

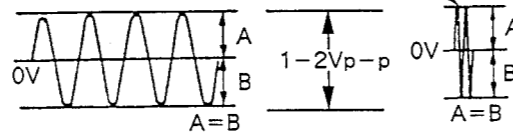

Adjustment Location : main board

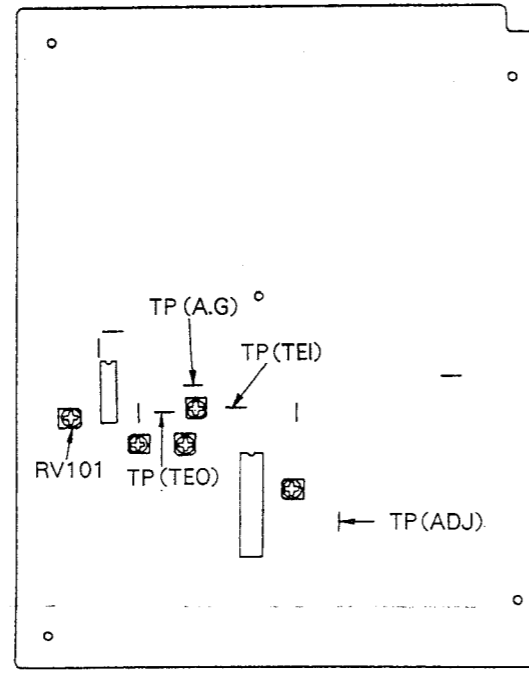

Focus Bias Adjustment

This adjustment should be made when replacing Optical Pick-up Block.

Procedure :

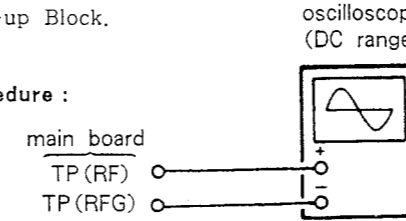

1. Connect oscilloscope to test points TP(RF) and TP (RF G).
2. Turn POWER switch on.
3. Put disc (YEDS-18) in and playback the 6th selection.
4. Adjust RV104 for an optimum waveform eye pattern or so that the peak is maximum. Optimum eye pattern means that shape "◇" can be clearly distinguished at the center of the waveform.

● RF Signal Reference Waveform (eye pattern)

VOLT/DIV : 200mV
TIME/DIV : 500nS

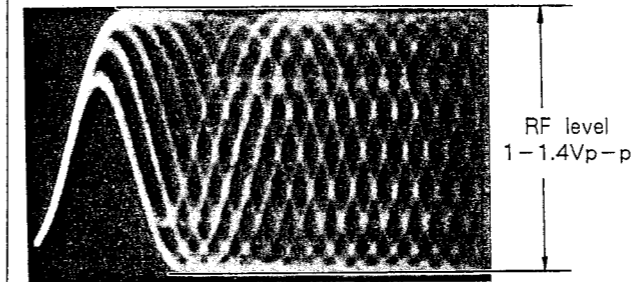

When observing the eye pattern, set the oscilloscope for AC range and raise vertical sensitivity.

Adjustment Location : main board

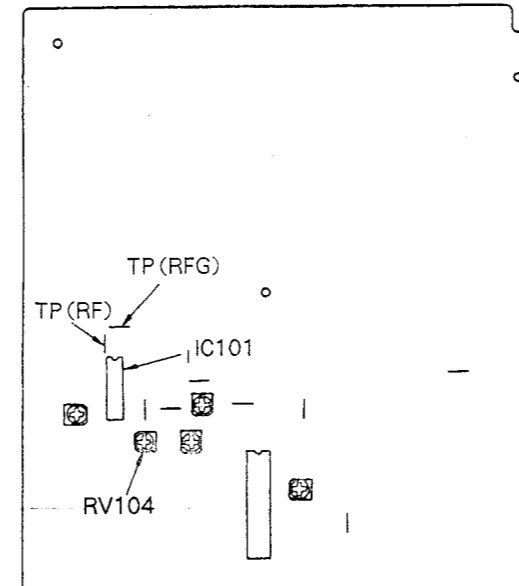

REFERENCE

Focus/Tracking Gain Adjustment

A frequency response analyzer is necessary in order to perform this adjustment exactly.

However, this gain has a margin, so even if it is slightly off, there is no problem. Therefore, do not perform this adjustment.

Focus/tracking gain determines the pick-up follow-up (vertical and horizontal) relative to mechanical noise and mechanical shock when the 2-axis device operate.

However, as these reciprocate, the adjustment is at the point where both are satisfied.

- When gain is raised, the noise when the 2-axis device operates increases.
- When gain is lowered, it is more susceptible to mechanical shock and skipping occurs more easily.
- When gain adjustment is off, the symptoms below appear.

	Gain	Focus	Tracking
● The time until music starts becomes longer for STOP →▷PLAY or automatic selection (⏮ ⏭ buttons pressed). (Normally takes about 2 seconds.)		low	low or high
● Music does not start and disc continues to rotate for STOP →▷PLAY or auto-matic selection (⏮ ⏭ buttons pressed.)		-	low
● Disc table opens shortly after STOP →▷PLAY.		low or high	-
● Sound is interrupted during PLAY. Or time counter display stops progressing.		-	low
● More poise during 2-axis device operation.	high		high

The following is a simple adjustment method.
-Simple Adjustment-

Note: Since exact adjustment cannot be performed, remember the positions of the controls before performing the adjustment. If the positions after the simple adjustment are only a little different, return the controls to the original position.

Procedure:

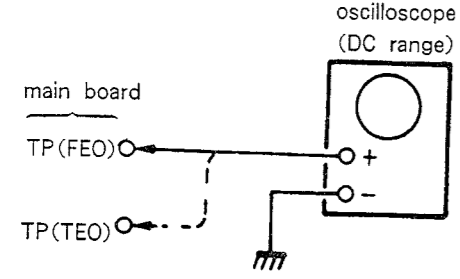

1. Keep the set horizontal. (If the set is not horizontal, this adjustment cannot be performed due to the gravity against the 2 axis device.)
2. Insert disc (YEDS-18) playback the 6th selection.
3. Connect oscilloscope to main board TP(FEO).
4. Adjust RV103 so that the waveform is as shown in the figure below. (focus gain adjustment)

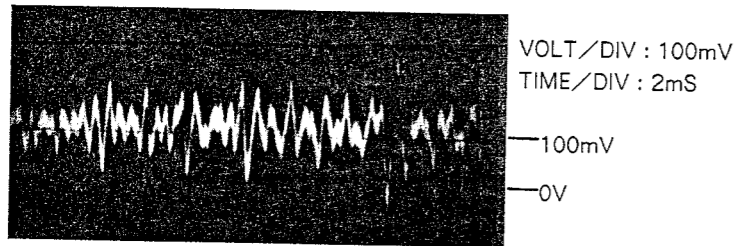

● Incorrect Examples (DC level changes more than on adjusted waveform)

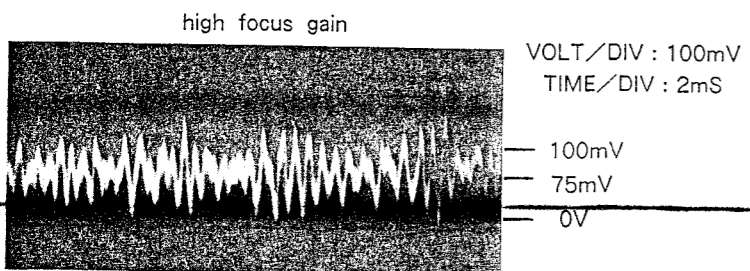
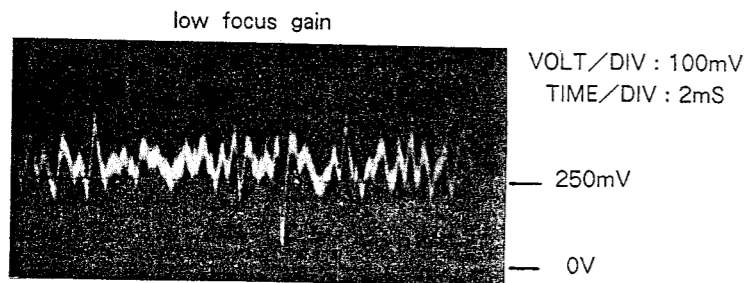

5. Connect oscilloscope to main board TP(TEO).
6. Adjust RV102 so that the waveform is as shown in the figure below. (tracking gain adjustment)

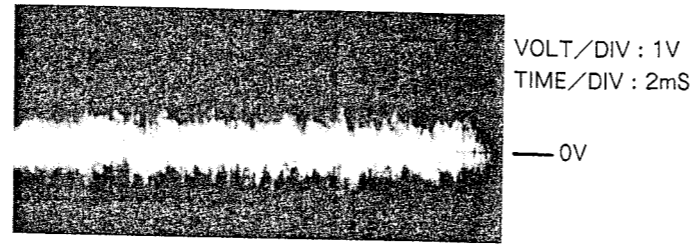

● Incorrect Examples (fundamental wave appears)

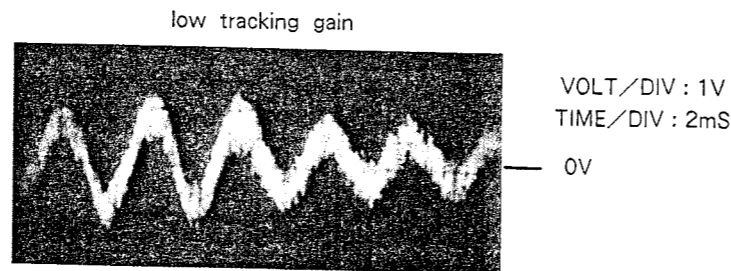

high tracking gain (higher fundamental wave than for low gain)

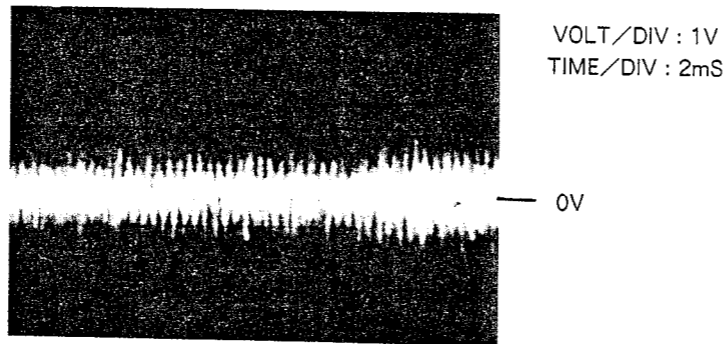

Adjustment Location: main board

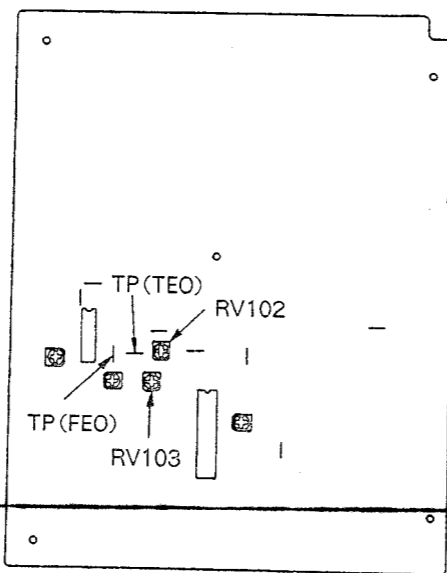

● IC BLOCK DIAGRAMS

IC101 CXA1081S

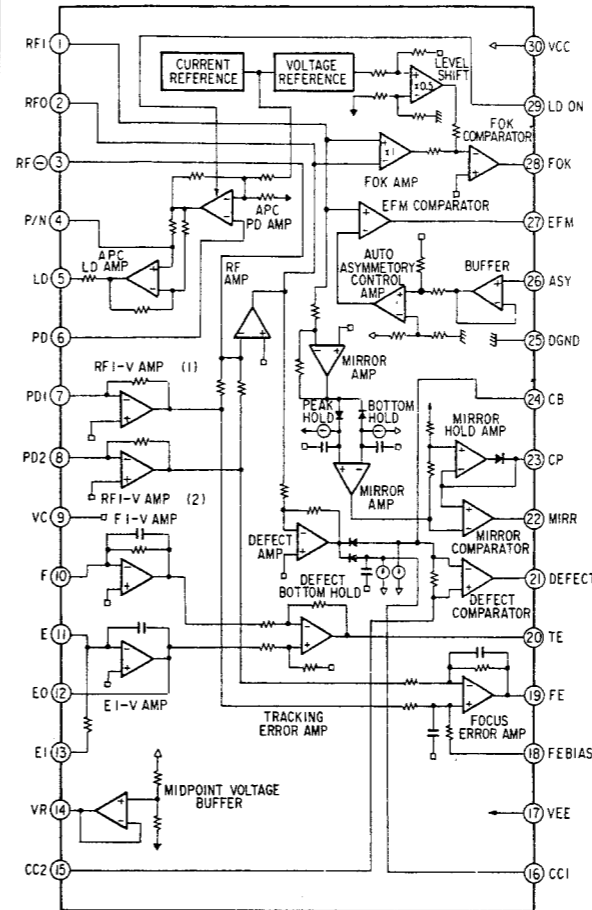

IC204 CXA1182S

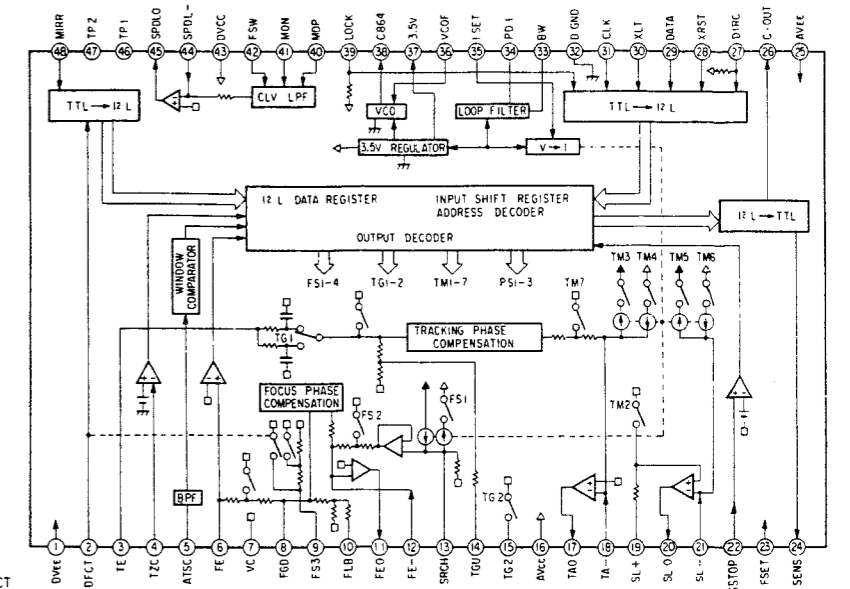

IC521 TDA1541-N5

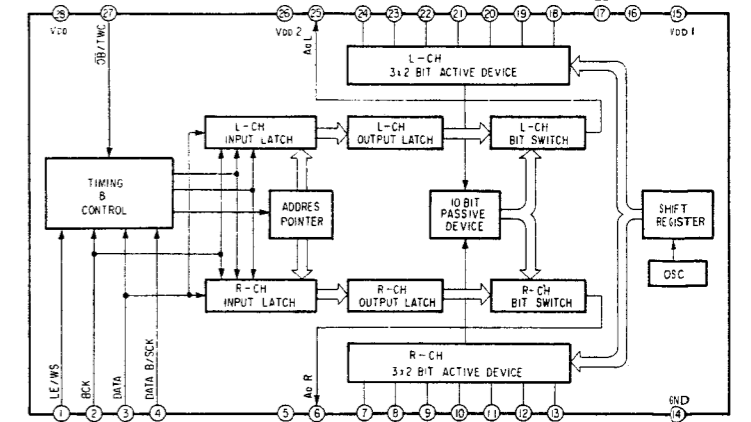

IC520 CXD1088Q

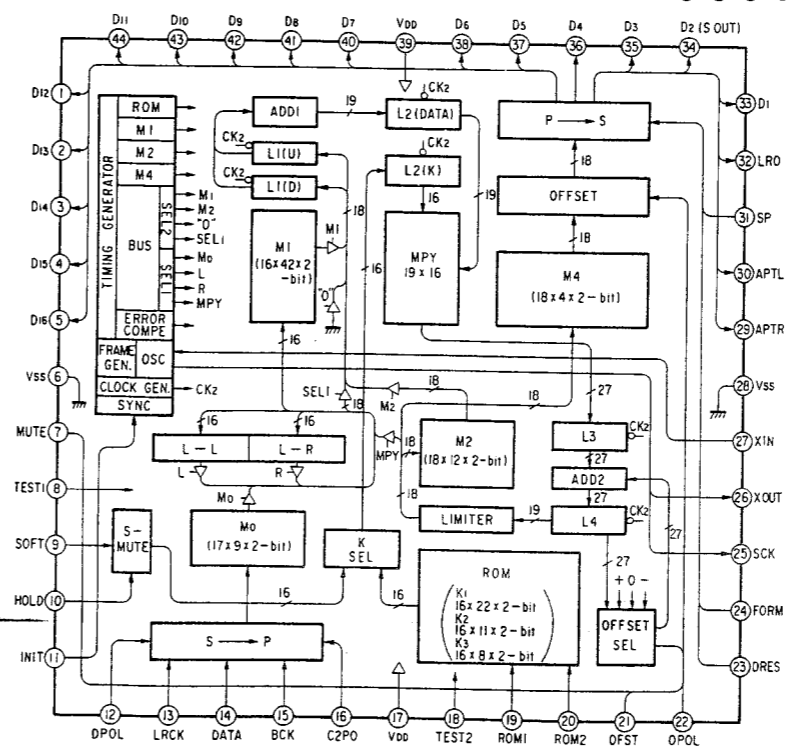

IC802 BX-1387

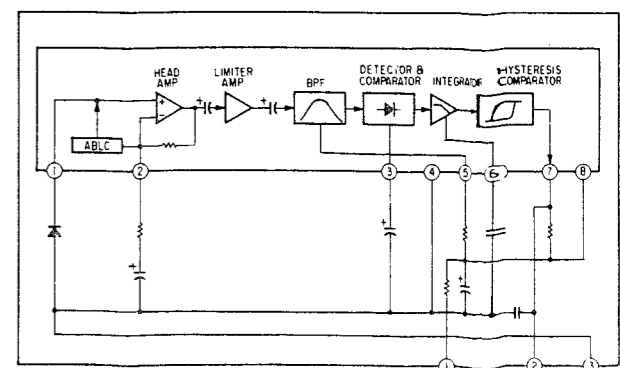

adjustment method.

cannot be performed, of the controls before t. If the positions after the ly a little different, return inal position.

illoscope (range)

this adjustment cannot be against the 2 axis device.) ack the 6th selection. n board TP(FEO). waveform is as shown in in adjustment)

el changes more than on

5. Connect oscilloscope to main board TP(TEO).
6. Adjust RV102 so that the waveform is as shown in the figure below. (tracking gain adjustment)

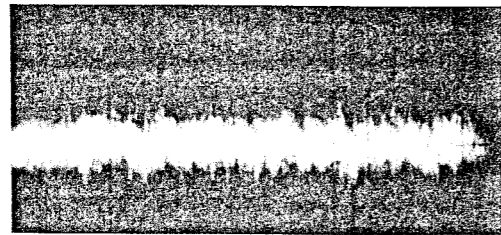

VOLT/DIV : 1V
TIME/DIV : 2mS

Incorrect Examples (fundamental wave appears)

low tracking gain

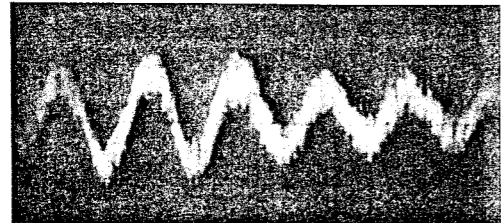

VOLT/DIV : 1V
TIME/DIV : 2mS

high tracking gain (higher fundamental wave than for low gain)

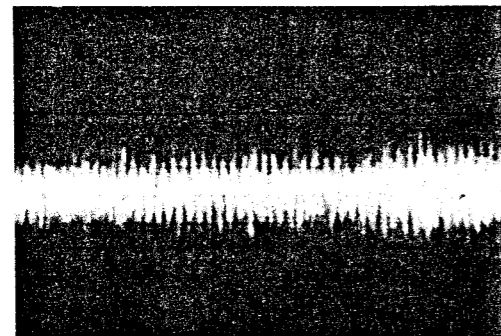

VOLT/DIV : 1V
TIME/DIV : 2mS

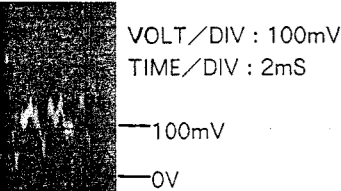

VOLT/DIV : 100mV
TIME/DIV : 2mS

100mV
0V

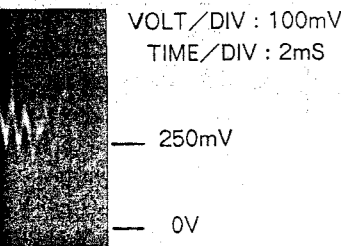

VOLT/DIV : 100mV
TIME/DIV : 2mS

250mV

0V

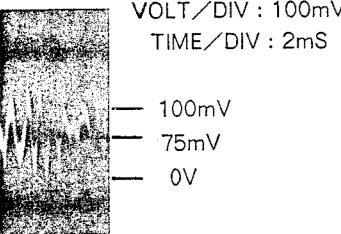

VOLT/DIV : 100mV
TIME/DIV : 2mS

100mV

75mV

0V

Adjustment Location : main board

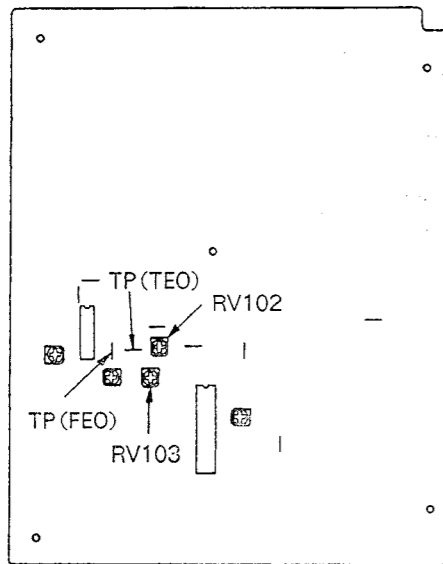

IC BLOCK DIAGRAMS

IC101 CXA1081S

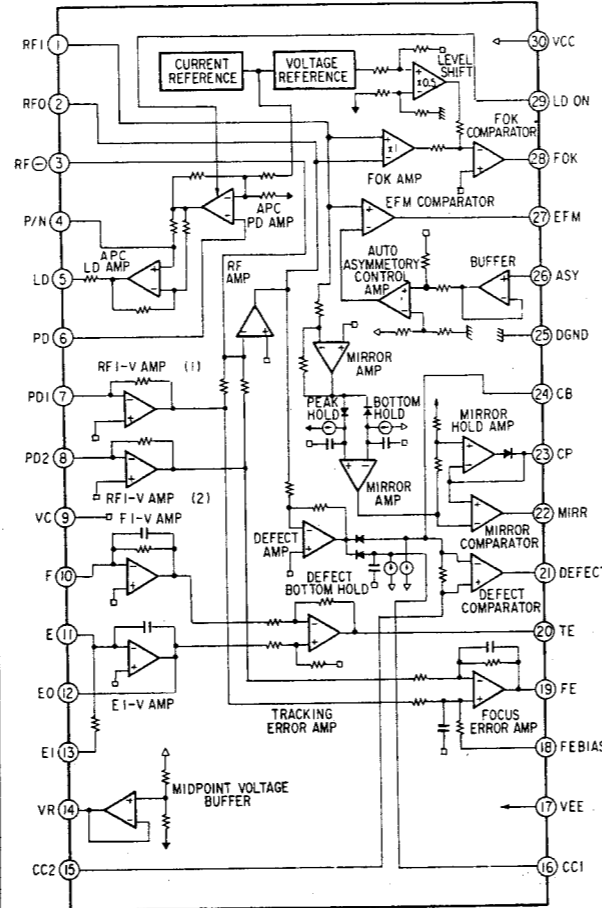

IC204 CXA1182S

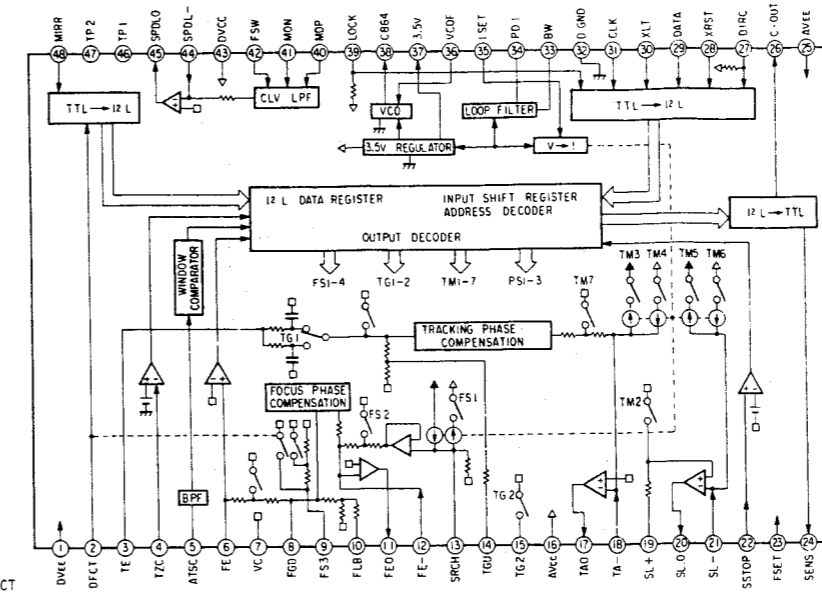

IC521 TDA1541-N5

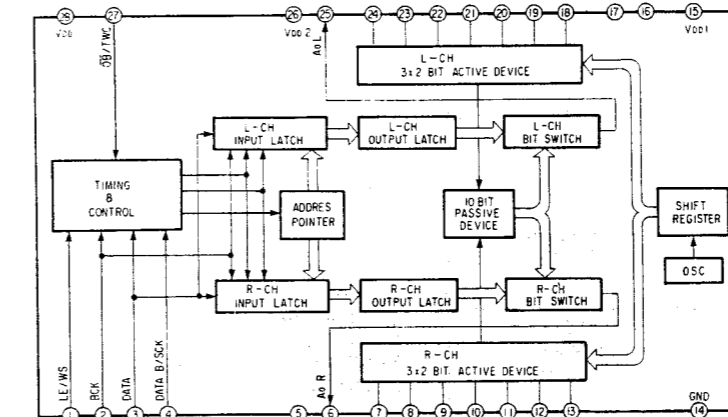

IC520 CXD1088Q

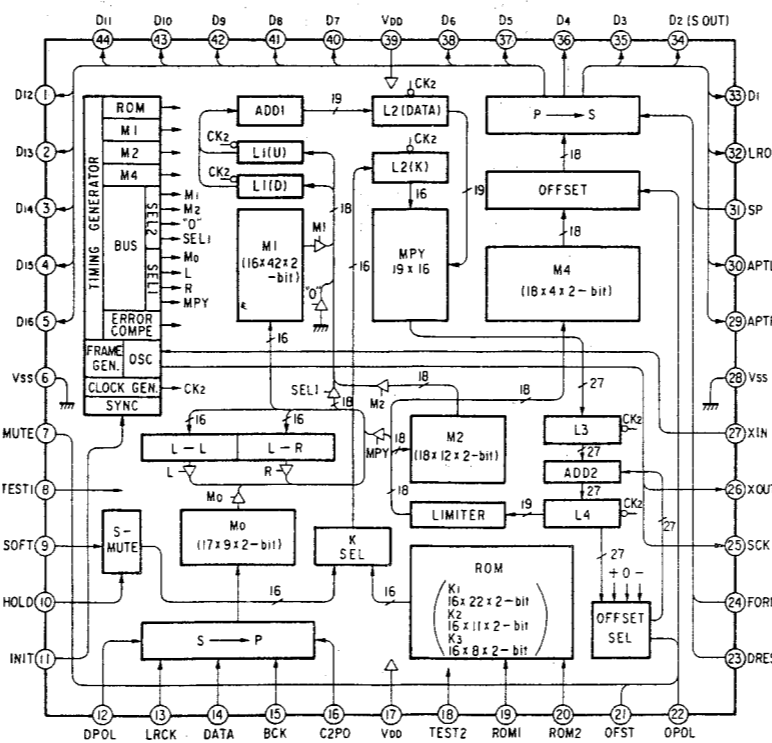

IC802 BX-1387

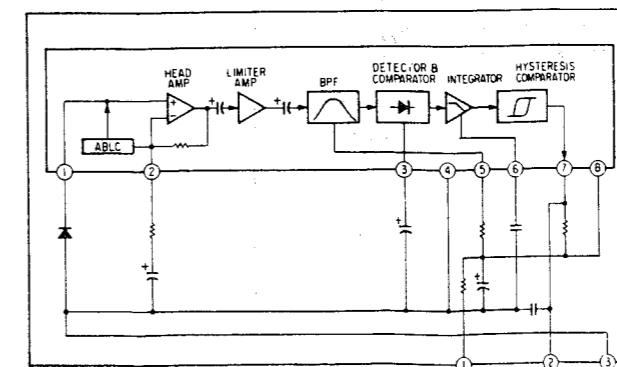

IC302 CXD1125Q

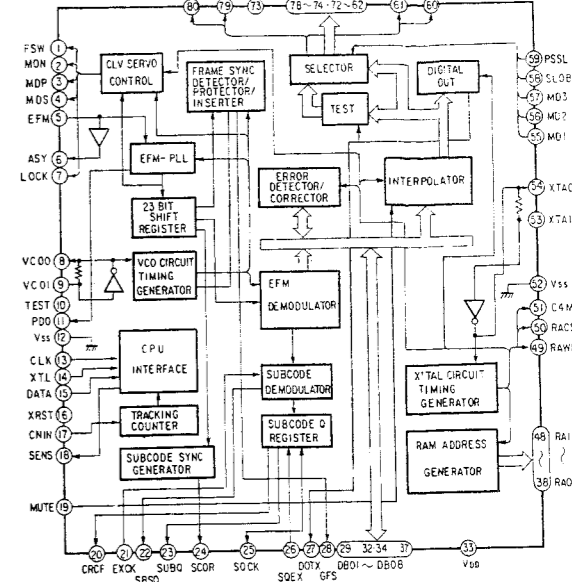

IC201 TA7256P

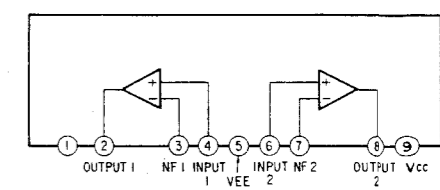

IC390 BA6208

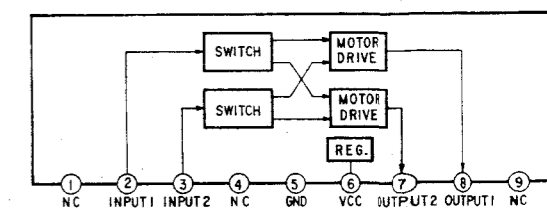

IC202 LA6520

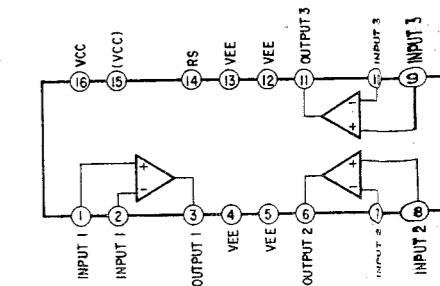

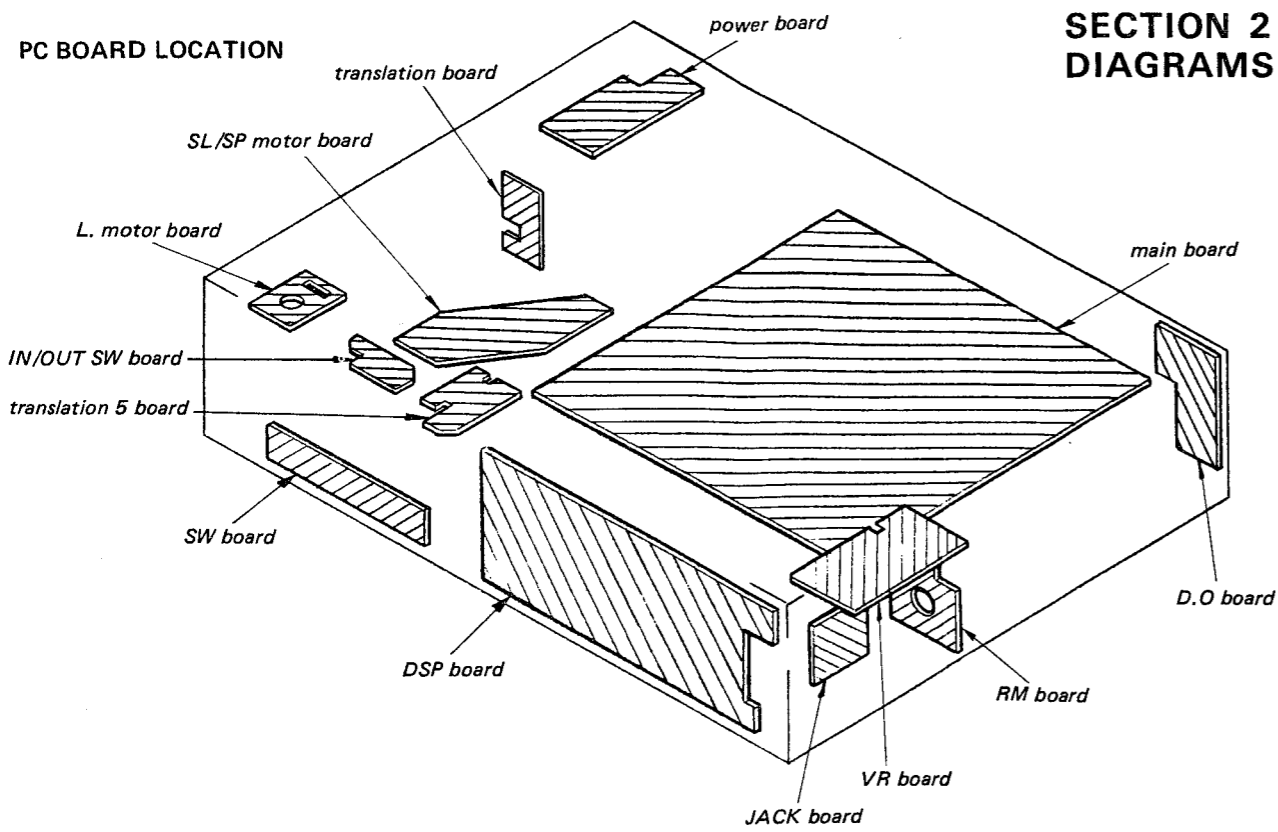

SEMICONDUCTOR LOCATION

Ref.No.	Location	Ref.No.	Location
IC101	G-23	Q500	C-20
IC201	J-23	Q501	B-19
IC202	I-23	Q502	B-19
IC203	J-22	Q520	E-20
IC204	I-21	Q521	D-20
IC301	J-19	Q522	E-20
IC302	G-19	Q801	J-7
IC303	G-20	Q840	B-22
IC351	J-17		
IC352	H-17		
IC380	E-17	D101	H-24
IC390	F-27	D201	K-22
IC400	C-18	D901	D-23
IC450	F-27	D902	D-23
IC500	C-19	D903	E-22
IC520	F-18	D904	F-23
IC521	E-19	D905	E-23
IC801	J-8	D906	E-23
IC802	G-3	D907	E-21
IC900	D-22	D908	D-23
IC910	C-22	D909	D-23
IC920	B-22	D910	C-23
IC930	F-23	D911	C-23
IC940	F-21	D912	F-21
		D920	C-23
		D921	C-23
Q101	H-24	D940	B-23
Q202	K-22	D941	B-23
Q203	K-22	D943	B-23
Q204	K-22	D944	B-22
Q205	J-20	D945	E-24
Q206	J-20		
Q301	I-19		
Q400	D-17		
Q401	B-18		
Q402	B-18		

Semiconductor Lead Layouts

BA6208 	CXK5816M-10L 	M5278L56 	TA7256P 	1S5132
CXA1081S LC6523H-3446 	LA6520 	M50740A-424SP 	2SA1348 2SC3399 2SC3402 	GP08DPKG23 HZS4.3NB3 HZS33-2L HZS9B2L
CXA1182S 	LC9600R-183 TDA1541-N5 	MSM6408-26SS 	2SB734 	
CXD1088Q 	MC74HC02N TC74HCOOP 	NJM4556S 	2SC2021 	
CXD1125Q CXP5058H-060Q 	M5F7805 M5F7905 M5F7915 	NJM5532D-D 	2SC3622A-K 	

Note:

- Color code or sleeving over the end of the jacket.

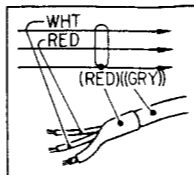

- : parts extracted from the component side.
- : parts mounted on the conductor side.
- : Jumper wire connected to the ground pattern on the component side.

PRINTED WIRING BOARDS

• See page 18 for IC BLOCK DIAGRAMS

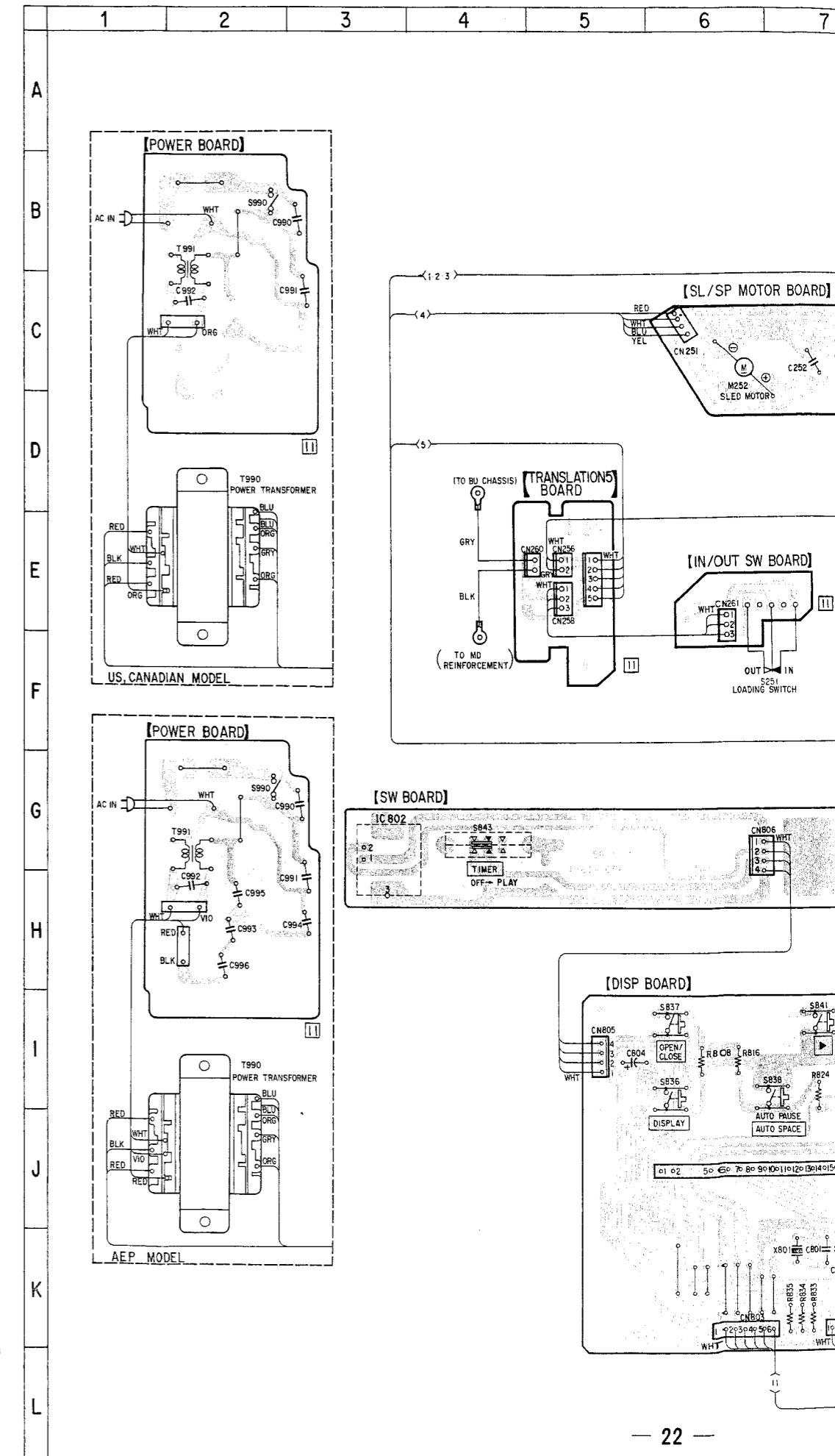

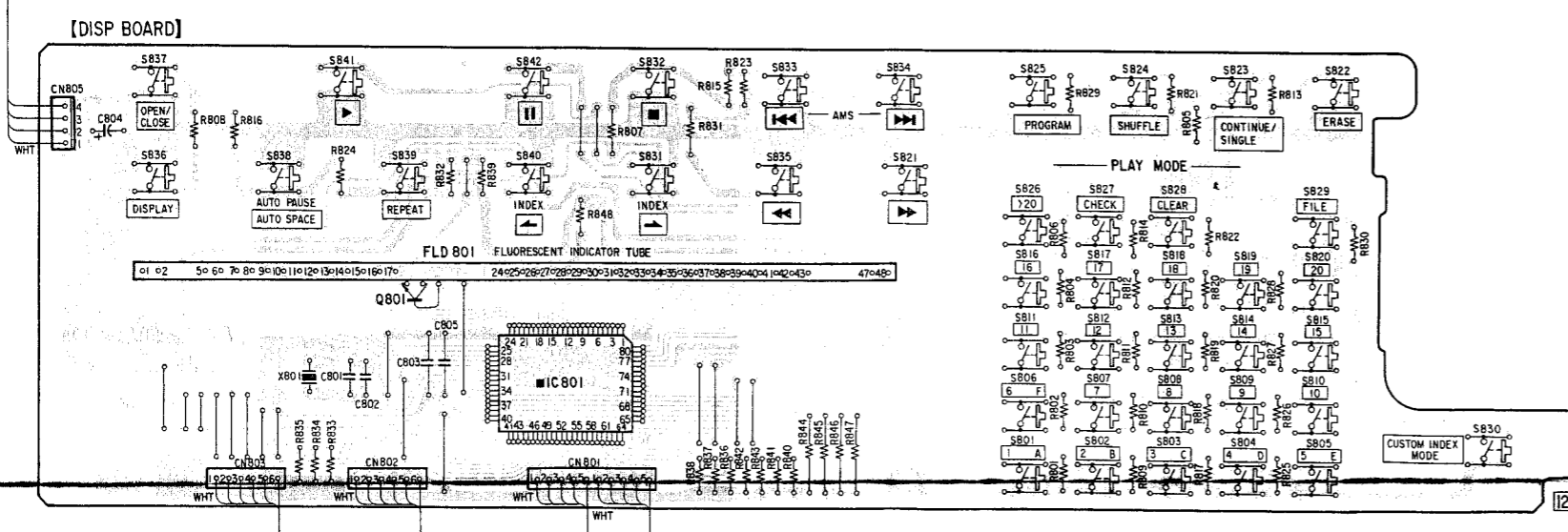
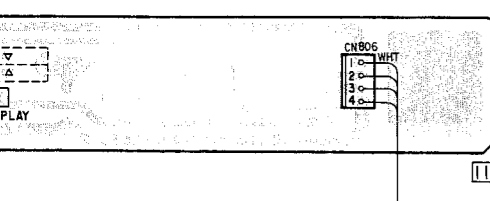
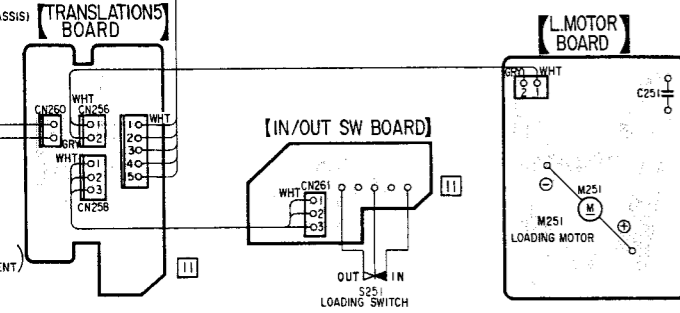
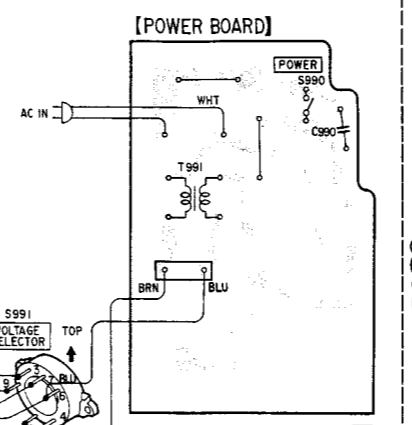
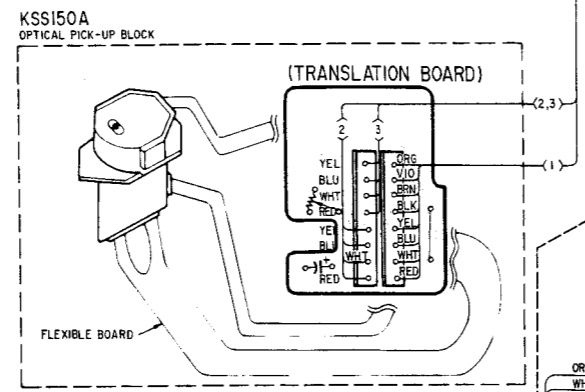
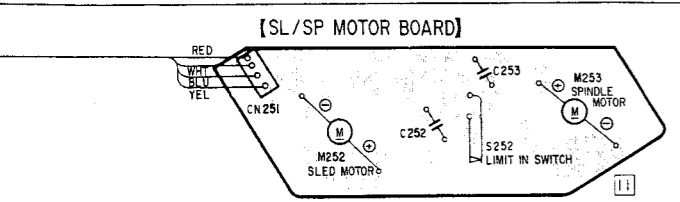

CDP-950 (CANADIAN, AEP MODEL)
 CDP-307ESD (US, E MODEL)

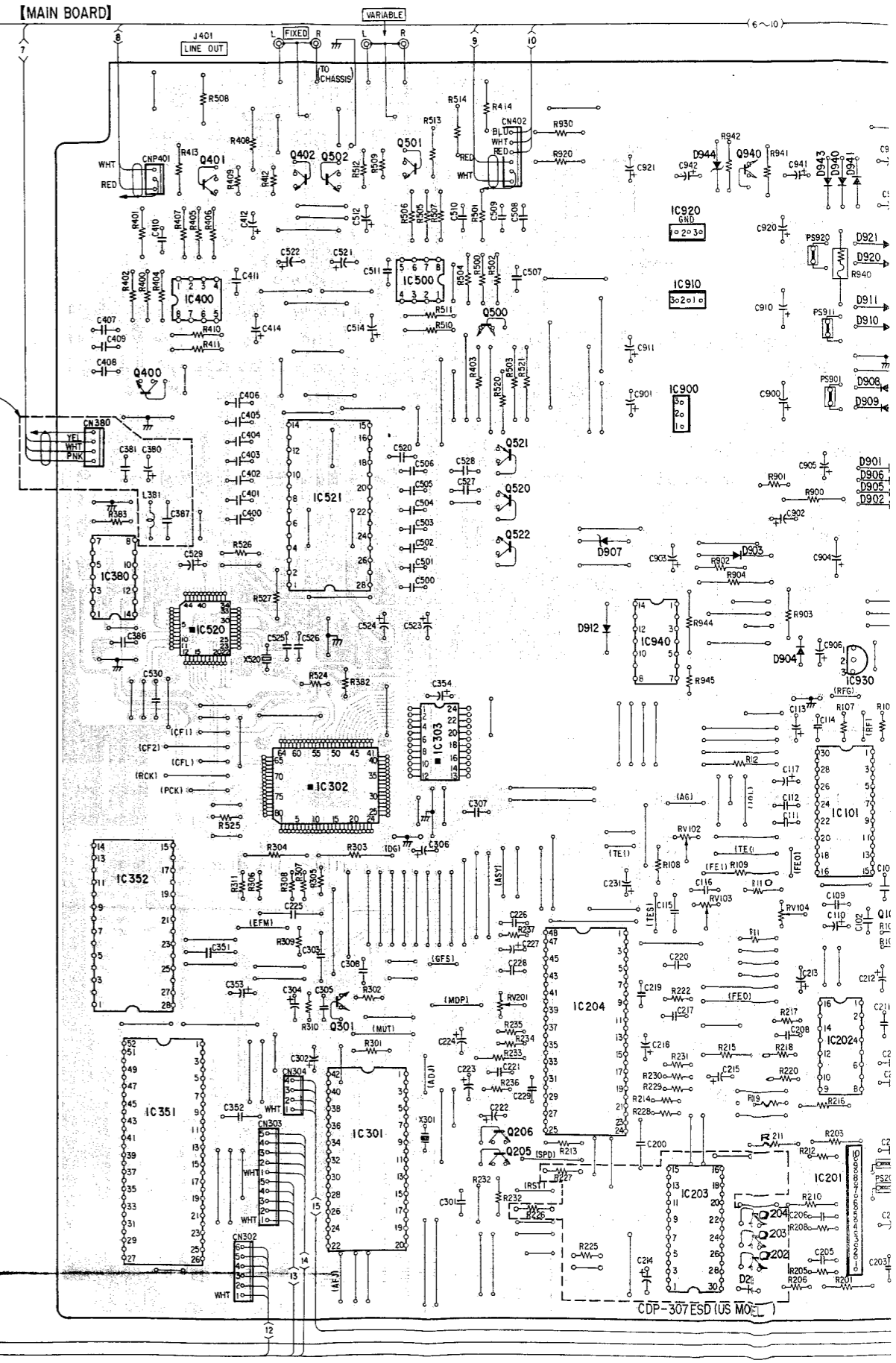

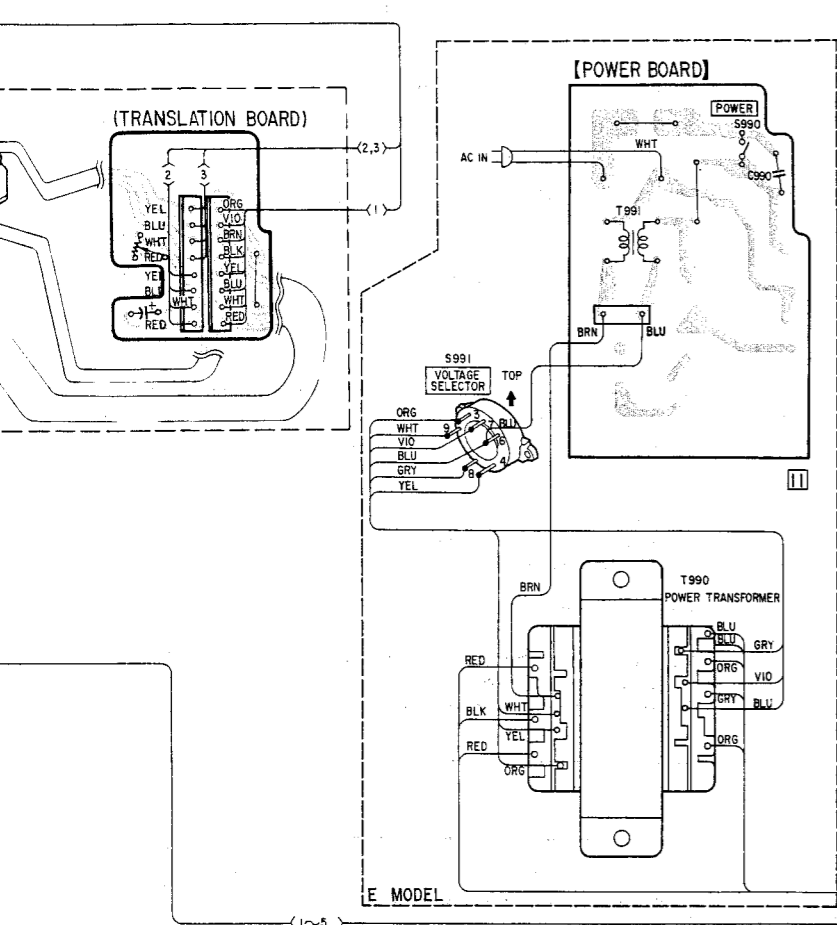

CDP-950 (CANADIAN, AEP MODEL)
CDP-307ESD (US, E MODEL)

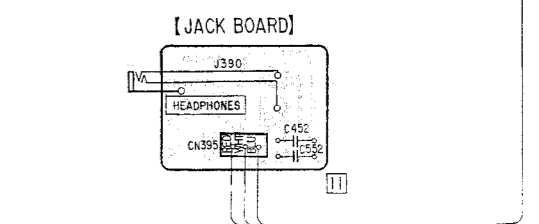
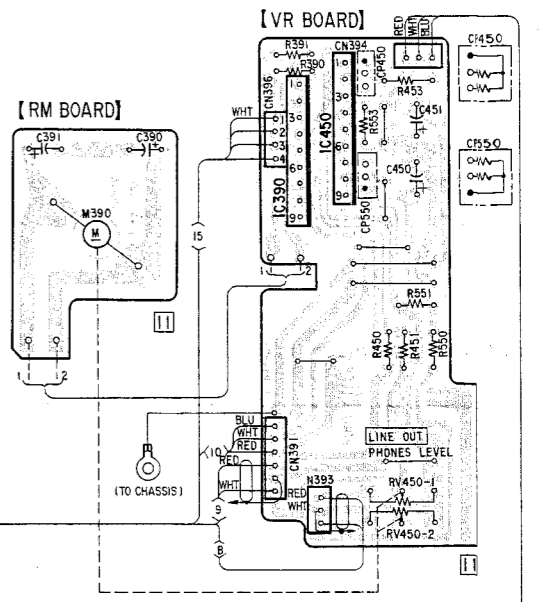
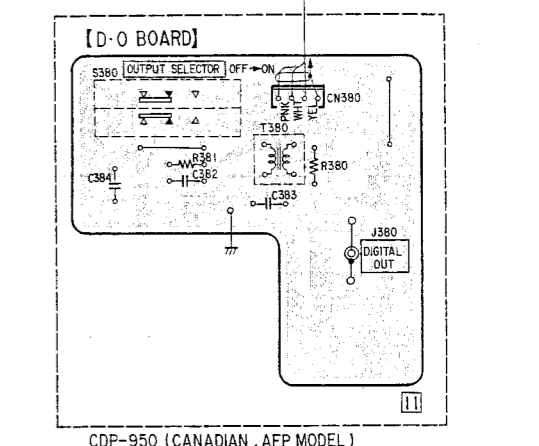
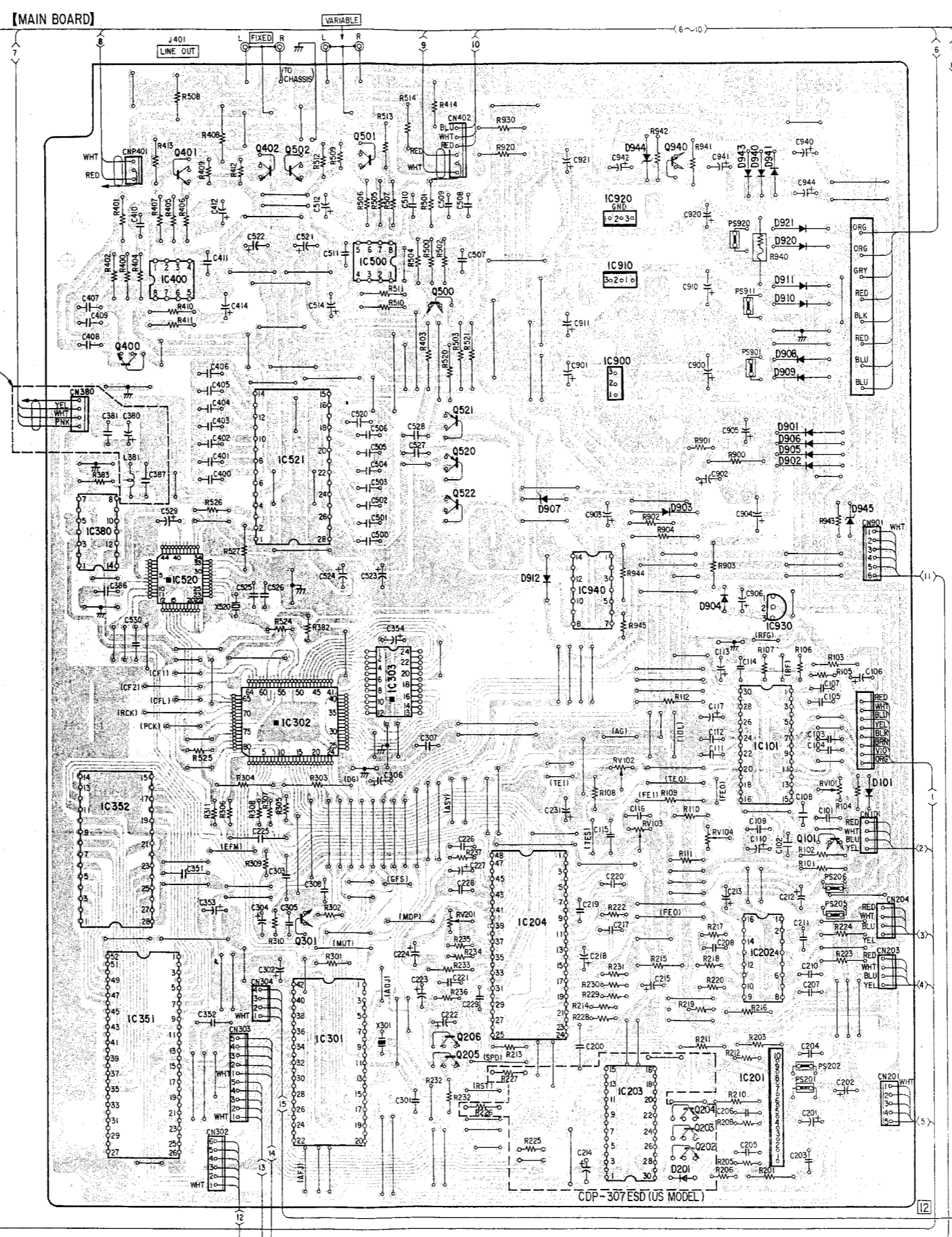
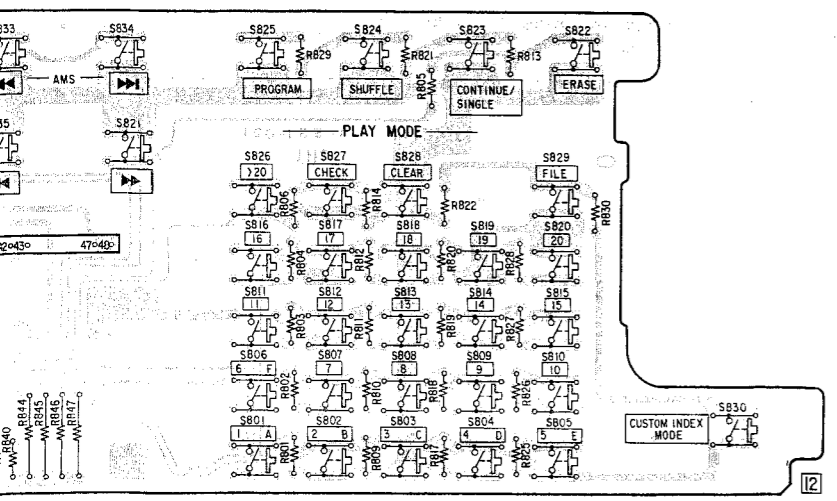

SECTION 3 EXPLODED VIEWS AND PARTS LIST

NOTE:

- The mechanical parts with no reference number in the exploded views are not supplied.
- The construction parts of an assembled part are indicated with a collation number in the remark column.
- Items marked “*” are not stocked since they are seldom required for routine service. Some delay should be anticipated when ordering these items.

- Due to standardization, parts with part number suffix -XX and -X may be different from the parts specified in the components used on the set.

• Color Indication of Appearance Parts
 Example:
 (RED) ... KNOB, BALANCE (WHITE)
 ↑ ↑
 Cabinet's Color Parts' Color

The components identified by shading and mark are critical for safety. Replace only with part number specified.

Les composants identifiés par une trame et une marque sont critiques pour la sécurité. Ne les remplacer que par une pièce portant le numéro spécifié.

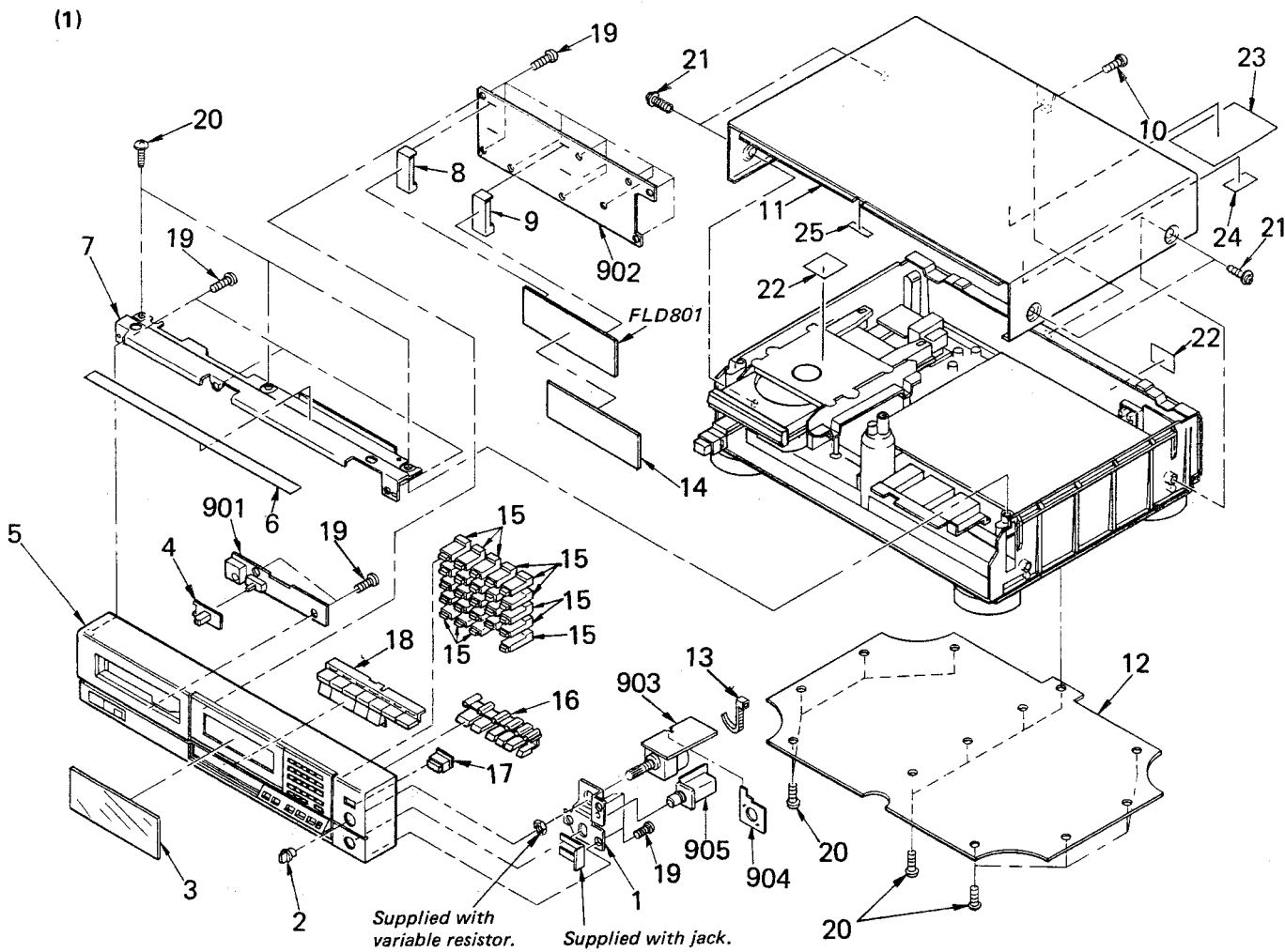





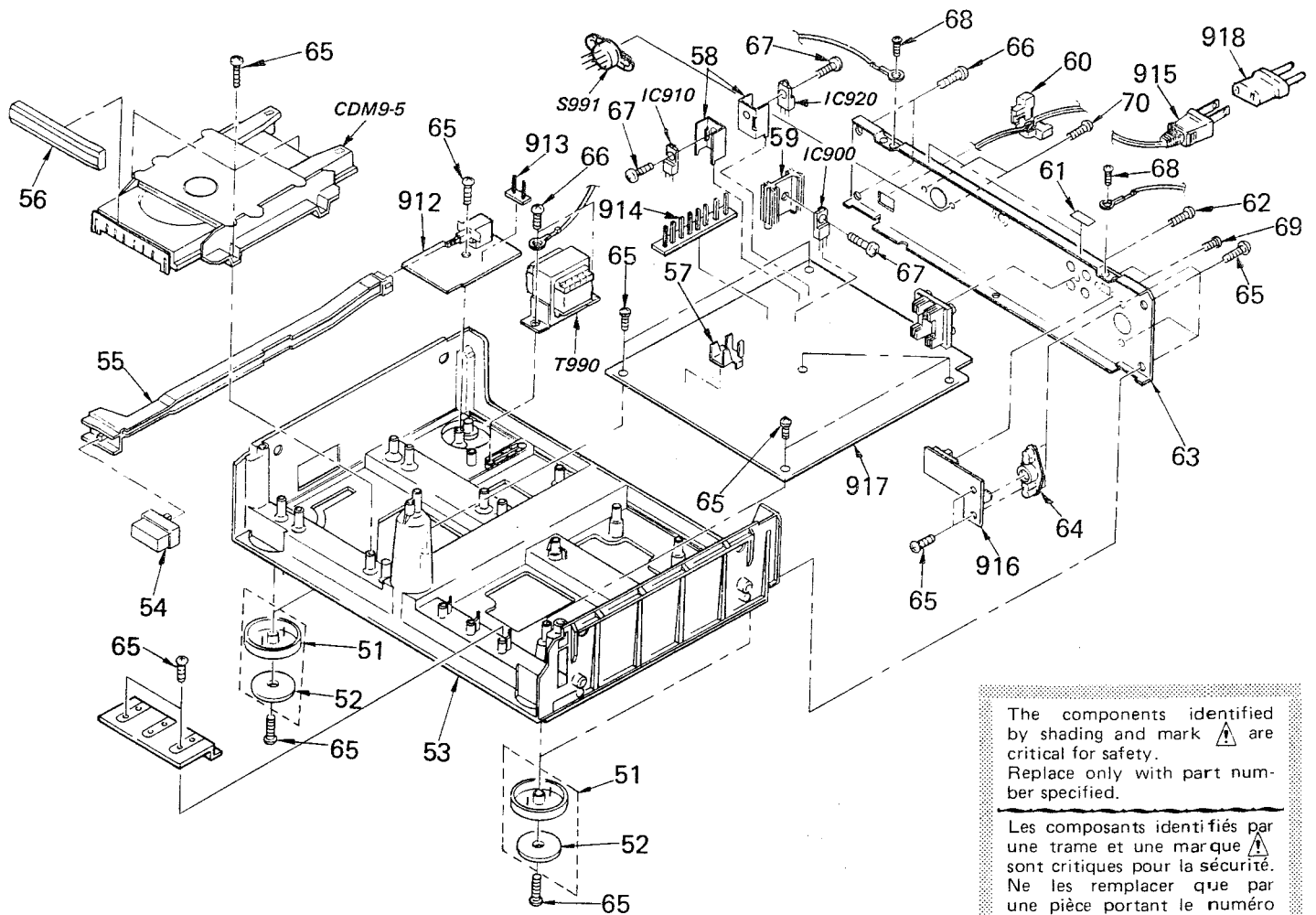



No.	Part No.	Description	Remarks	No.	Part No.	Description	Remarks
1	*4-922-520-01	BRACKET, VR		14	4-922-519-01	FILTER	
2	4-922-531-01	KNOB (A TYPE), VOL		15	4-922-920-01	BUTTON (M.C)	
3	4-922-918-11	(950,307ESD:E)...PLATE, INDICATION		16	4-922-923-01	BUTTON (AMS)	
	4-922-918-21	(307ESD:US).....PLATE, INDICATION		17	4-922-522-01	BUTTON (C.I)	
4	4-922-518-01	KNOB (TIMER)		18	X-4922-908-1	BUTTON ASSY	
5	X-4922-503-1	(950:US).....PANEL ASSY, FRONT		19	7-685-134-19	SCREW +BTP 2.6X8 TYPE2 N-S	
	X-4922-504-1	(307ESD).....PANEL ASSY, FRONT		20	7-685-647-79	SCREW +BVTP 3X10 TYPE2 N-S	
	X-4922-507-1	(950:Canadian,AEP)...PANEL ASSY, FRONT		21	4-886-821-01	SCREW M3 CASE	
6	*4-922-933-01	SPACER		22	*4-885-838-00	(950:AEP,307ESD:E)...LABEL, CLASS 1	
7	*4-922-924-01	BRACKET, PANEL		23	*4-917-634-01	DAMPER (C)	
8	*4-922-524-01	HOLDER (LEFT)		24	3-831-441-XX	CUSHION (T)	
9	*4-922-523-01	HOLDER (RIGHT)		25	*4-922-937-01	CUSHION	
10	7-685-646-79	SCREW, TAPPING		901	*1-624-054-11	PC BOARD, SW	
11	4-912-939-01	CASE		902	*1-624-051-11	PC BOARD, DISP	
12	*4-922-927-11	BOARD, BOTTOM		903	*1-624-052-11	PC BOARD, VR	
13	3-701-748-00	CLAMP		904	*1-624-055-11	PC BOARD, RM	
				905	*1-624-053-11	PC BOARD, JACK	
				FLD801	1-519-428-11	INDICATOR TUBE, FLUORESCENT	

(2)



The components identified by shading and mark  are critical for safety. Replace only with part number specified.

Les composants identifiés par une trame et une marque  sont critiques pour la sécurité. Ne les remplacer que par une pièce portant le numéro spécifié.

No.	Part No.	Description	Remarks	No.	Part No.	Description	Remarks
51	X-4922-508-1	(950:Canadian,AEP,307ESD)...FOOT ASSY	52	68	7-682-547-09	SCREW +BVTT 3X6 (S)	
52	4-922-915-01	(950:Canadian,AEP,307ESD)...FOOT (FELT)		69	7-621-773-86	SCREW +P 2.6X4	
	4-922-942-01	(950:US).....FOOT (FELT)		70	7-682-546-09	(307ESD:E)...CREW +B 3X5	
53	*4-922-928-01	CHASSIS		912	*1-624-049-11	PC BOARD, POWER	
54	4-917-460-01	KNOB, POWER		913	*1-535-139-00	BASE POST 19MM (10MM PITCH) 2P	
55	*4-922-530-01	LEVER, POWER SWITCH		914	*1-535-121-00	TERMINAL	
56	4-922-410-41	(950:US).....PANEL, LOADING		915	 1-555-795-00	(950:AEP)....CORD, POWER	
	4-922-919-21	(950:Canadian,AEP,307ESD)..PANEL, LOADING			 1-556-091-00	(307ESD:E)....CORD, POWER	
					 1-557-577-11	(950:US,Canadian,307ESD:US)...CORD, POWER	
57	*4-922-525-01	HEAT SINK		916	*1-624-050-11	(950:Canadian,AEP,307ESD)...PC BOARD, D.O	
58	*3-309-144-01	HEAT SINK		917	*A-4651-157-A	(950:AEP,307ESD:E)...MOUNTED PCB, MAIN	
59	*4-908-502-01	HEAT SINK			*A-4651-180-A	(950:US).....MOUNTED PCB, MAIN	
60	*3-703-244-00	(950,307ESD:US)...BUSHING (2104), CORD			*A-4651-181-A	(950:Canadian).....MOUNTED PCB, MAIN	
	*3-703-571-11	(307ESD:E)....BUSHING (S)(4516), CORD			*A-4651-182-A	(307ESD:US).....MOUNTED PCB, MAIN	
61	3-568-749-00	CUSHION, ECM		918	 1-526-565-00	(307ESD:E)...AC PLUG ADAPTOR	
62	4-909-982-01	SCREW, TAPPING		IC900	8-759-604-29	IC M5F7805	
63	*4-922-502-11	(307ESD:US).....PANEL, BACK		IC910	8-759-604-47	IC M5F7905	
	*4-922-503-21	(950:AEP).....PANEL, BACK		IC920	8-759-604-52	IC M5F7915	
	*4-922-502-31	(307ESD:E).....PANEL, BACK		S991	 1-526-576-11	(307ESD:E)...SELECTOR, POWER VOLTAGE (VOLTAGE SELECTOR)	
	*4-922-503-41	(950:Canadian)...PANEL, BACK		T990	 1-449-029-11	(950:US,Canadian,307ESD:US) ...TRANSFORMER, POWER	
	*4-922-503-71	(950:US).....PANEL, BACK		T990	 1-449-030-11	(950:AEP).....TRANSFORMER, POWER	
64	*4-913-152-01	(950:Canadian,AEP,307ESD)..ESCUTCHEON, D/O		T990	 1-449-031-11	(307ESD:E)....TRANSFORMER, POWER	
65	7-685-647-79	SCREW +BVTP 3X10 TYPE2 N-S					
66	7-685-660-11	SCREW +BVTP 4X10 TYPE2 N-S					
67	7-682-147-15	SCREW, TR					

(3) MECHANISM SECTION
(CDM9-5)

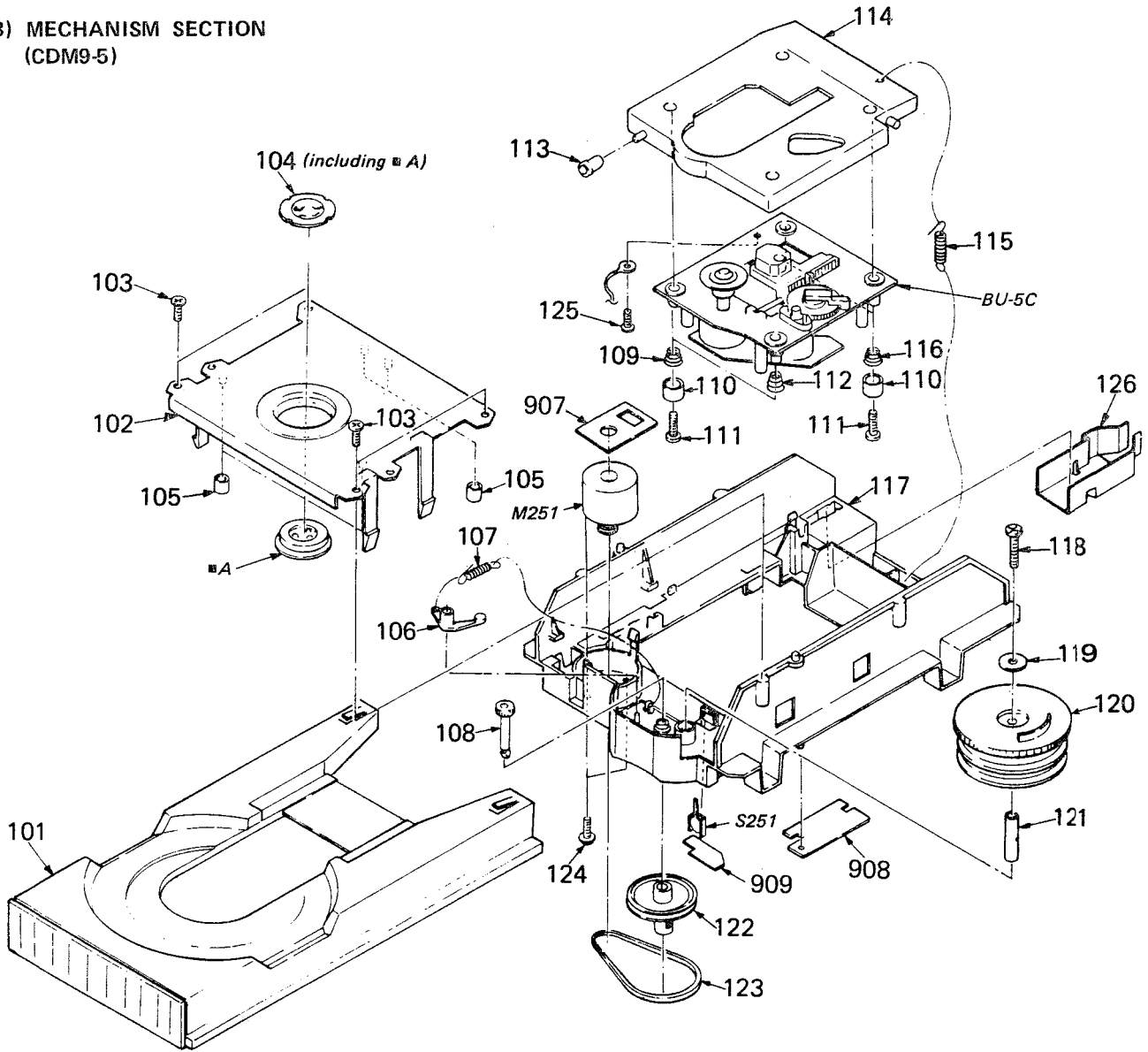

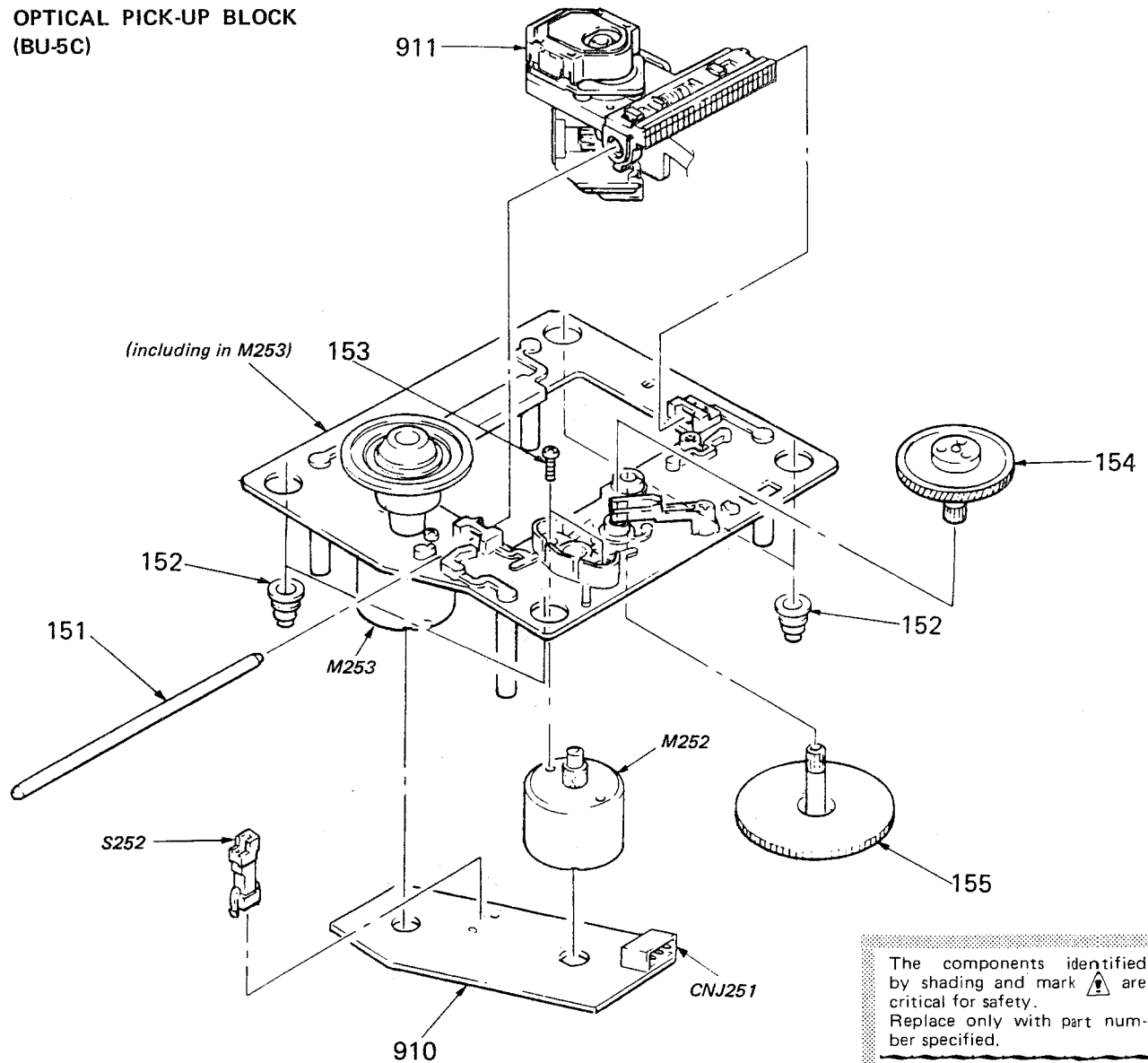

No.	Part No.	Description	Remarks	No.	Part No.	Description	Remarks
101	*4-922-515-01	TABLE, DISK		116	4-917-507-01	SPRING (H)	
102	*4-922-510-01	REINFORCEMENT		117	*4-922-516-01	CHASSIS (MD)	
103	7-685-646-79	SCREW +BTP 3X8 TYPE2 N-S		118	7-685-552-19	SCREW +BTP 3X25 TYPE2 N-S	
104	A-4665-012-C	MAGNET ASSY		119	0-056-028-00	WASHER, PLAIN, 14 DIA.	
105	*3-576-990-01	CUSHION		120	4-922-511-01	GEAR (LOADING)	
106	4-917-519-01	LEVER, SET		121	*4-917-523-01	COLLAR, CAM	
107	4-917-514-01	SPRING, TENSION		122	4-922-512-01	PULLEY	
108	4-922-508-01	GEAR (DRIVING)		123	4-917-522-01	BELT	
109	4-917-541-01	SPRING (B)		124	7-621-759-40	+PSW, 2.6X6	
110	4-917-508-01	HOLDER, SP		125	7-621-770-67	SCREW +BVTT 2.6X6 (S)	
111	7-685-535-19	SCREW +BTP 2.6X10 TYPE2 N-S		126	4-923-541-11	SPRING	
112	4-918-669-01	SPRING (W)		907	*1-624-324-11	PC BOARD, L.MOTOR	
113	4-917-515-01	ROLLER		908	*1-624-325-11	PC BOARD, TRANSLATION 5	
114	*4-922-514-01	BRACKET (BU-5)		909	*1-624-323-11	PC BOARD, IN/OUT SW	
115	4-917-526-01	SPRING, TENSION		M251	A-4608-346-A	MOTOR ASSY, L	
				S251	1-571-300-11	SWITCH, ROTARY (LOADING IN/OUT)	

(4) OPTICAL PICK-UP BLOCK
(BU-5C)



The components identified by shading and mark  are critical for safety. Replace only with part number specified.

Les composants identifiés par une trame et une marque  sont critiques pour la sécurité. Ne les remplacer que par une pièce portant le numéro spécifié.

No.	Part No.	Description	Remarks	No.	Part No.	Description	Remarks
151	4-917-565-01	SHAFT, SLED		910	*1-624-322-11	PC BOARD, SL/SP MOTOR	
152	4-917-562-01	INSULATOR		911	 8-848-062-01	DEVICE, OPTICS (KSS-150A)	
153	7-621-255-15	SCREW +P 2X3		CNJ251*	1-564-720-21	PIN, CONNECTOR (SMALL TYPE) 4P	
154	4-917-567-01	GEAR (M)		M252	X-4917-504-1	ASSY, MOTOR (SLED)	
155	4-917-564-01	GEAR (P), FLATNESS		M253	X-4917-523-1	ASSY, MOTOR (SPINDLE)	
				S252	1-571-274-11	SWITCH, LEAF (LIMIT IN)	

SECTION 4 ELECTRICAL PARTS LIST

NOTE:

- Due to standardization, replacements in the parts list may be different from the parts specified in the diagrams or the components used on the set.
- Items marked "*" are not stocked since they are seldom required for routine service. Some delay should be anticipated when ordering these items.
- If there are two or more same circuits in a set such as a stereophonic machine, only typical circuit parts may be indicated and capacitors and resistors in other same circuits may be omitted.

CAPACITORS:

MF: μ F, PF: μ μ F.

RESISTORS

- All resistors are in ohms.
- F: nonflammable

COILS

• MMH: mH, UH: μ H

SEMICONDUCTORS

In each case, U: μ , for example:
 UA...: μ A..., UPA...: μ PA...,
 UPC...: μ PC, UPD...: μ PD...

The components identified by shading and mark are critical for safety. Replace only with part number specified.

Les composants identifiés par une trame et une marque sont critiques pour la sécurité. Ne les remplacer que par une pièce portant le numéro spécifié.

Ref.No.	Part No.	Description	Ref.No.	Part No.	Description
901	*1-624-054-11	PC BOARD, SW	C205	1-162-294-31	CERAMIC 0.001MF 10% 50V
902	*1-624-051-11	PC BOARD, DISP	C206	1-162-294-31	CERAMIC 0.001MF 10% 50V
903	*1-624-052-11	PC BOARD, VR	C207	1-162-851-11	CERAMIC 0.1MF 20% 16V
904	*1-624-055-11	PC BOARD, RM	C208	1-136-169-00	FILM 0.22MF 5% 50V
905	*1-624-053-11	PC BOARD, JACK	C210	1-162-851-11	CERAMIC 0.1MF 20% 16V
907	*1-624-324-11	PC BOARD, L.MOTOR	C211	1-162-851-11	CERAMIC 0.1MF 20% 16V
908	*1-624-325-11	PC BOARD, TRANSLATION 5	C212	1-124-478-11	ELECT 100MF 20% 25V
909	*1-624-323-11	PC BOARD, IN/OUT SW	C213	1-124-478-11	ELECT 100MF 20% 25V
910	*1-624-322-11	PC BOARD, SL/SP MOTOR	C214	1-124-908-11	(307ESD:US)...ELECT 22MF 20% 25V
911	8-848-062-01	DEVICE, OPTICS (KSS-150A)	C215	1-123-875-11	ELECT 10MF 20% 50V
912	*1-624-049-11	PC BOARD, POWER	C217	1-136-165-00	FILM 0.1MF 5% 50V
913	*1-535-139-00	BASE POST 19MM (10MM PITCH) 2P	C218	1-123-382-00	ELECT 3.3MF 20% 50V
914	*1-535-121-00	TERMINAL	C219	1-136-159-00	FILM 0.033MF 5% 50V
915	1-555-795-00	(950:AEP).....CORD, POWER	C220	1-136-165-00	FILM 0.1MF 5% 50V
	1-556-091-00	(307ESD:E).....CORD, POWER	C221	1-130-479-00	MYLAR 0.0047MF 5% 50V
	1-557-577-11	(950:US,Canadian,307ESD:US) ...CORD, POWER	C222	1-124-499-11	ELECT 1MF 20% 50V
916	*1-624-050-11	(950:Canadian,AEP,307ESD) ...PC BOARD, D.O	C223	1-124-927-11	ELECT 4.7MF 20% 50V
917	*A-4651-157-A	(950:AEP,307ESD:E)...MOUNTED PCB, MAIN	C224	1-124-908-11	ELECT 22MF 20% 25V
	*A-4651-180-A	(950:US).....MOUNTED PCB, MAIN	C225	1-162-294-31	CERAMIC 0.001MF 10% 50V
	*A-4651-181-A	(950:Canadian).....MOUNTED PCB, MAIN	C226	1-162-282-31	CERAMIC 100PF 10% 50V
	*A-4651-182-A	(307ESD:US).....MOUNTED PCB, MAIN	C227	1-124-908-11	ELECT 22MF 20% 25V
918	1-526-565-00	(307ESD:E)...AC PLUG ADAPTOR	C228	1-162-851-11	CERAMIC 0.1MF 20% 16V
C101	1-162-294-31	CERAMIC 0.001MF 10% 50V	C229	1-162-851-11	CERAMIC 0.1MF 20% 16V
C102	1-124-443-00	ELECT 100MF 20% 6.3V	C231	1-124-908-11	ELECT 22MF 20% 25V
C103	1-162-199-31	CERAMIC 10PF 5% 50V	C251	1-136-157-00	FILM 0.022MF 5% 50V
C104	1-162-199-31	CERAMIC 10PF 5% 50V	C252	1-106-351-00	MYLAR 0.0022MF 5% 50V
C105	1-162-198-31	CERAMIC 8.2PF 10% 50V	C253	1-106-351-00	MYLAR 0.0022MF 5% 50V
C106	1-124-908-11	ELECT 22MF 20% 25V	C301	1-162-851-11	CERAMIC 0.1MF 20% 16V
C107	1-130-477-00	MYLAR 0.0033MF 5% 50V	C302	1-124-908-11	ELECT 22MF 20% 25V
C108	1-136-159-00	FILM 0.033MF 5% 50V	C303	1-161-379-00	CERAMIC 0.01MF 20% 16V
C109	1-162-851-11	CERAMIC 0.1MF 20% 16V	C304	1-124-902-00	ELECT 0.47MF 20% 50V
C110	1-124-908-11	ELECT 22MF 20% 25V	C305	1-136-159-00	FILM 0.033MF 5% 50V
C111	1-136-159-00	FILM 0.033MF 5% 50V	C306	1-124-443-00	ELECT 100MF 20% 6.3V
C112	1-136-153-00	FILM 0.01MF 5% 50V	C307	1-136-173-00	FILM 0.47MF 5% 50V
C113	1-124-908-11	ELECT 22MF 20% 25V	C308	1-162-851-11	CERAMIC 0.1MF 20% 16V
C114	1-162-851-11	CERAMIC 0.1MF 20% 16V	C351	1-161-379-00	CERAMIC 0.01MF 20% 16V
C115	1-161-375-00	CERAMIC 0.0022MF 30% 16V	C352	1-161-379-00	CERAMIC 0.01MF 20% 16V
C116	1-161-377-00	CERAMIC 0.0047MF 30% 16V	C353	1-124-908-11	ELECT 22MF 20% 25V
C117	1-124-902-00	ELECT 0.47MF 20% 50V	C354	1-124-908-11	ELECT 22MF 20% 25V
C200	1-161-379-00	CERAMIC 0.01MF 20% 16V	C380	1-124-908-11	(950:Canadian,AEP,307ESD) ...ELECT 22MF 20% 25V
C201	1-124-478-11	ELECT 100MF 20% 25V	C381	1-130-483-00	(950:Canadian,AEP,307ESD) ...MYLAR 0.01MF 5% 50V
C202	1-124-478-11	ELECT 100MF 20% 25V	C382	1-162-219-31	(950:Canadian,AEP,307ESD) ...CERAMIC 68PF 5% 50V
C203	1-162-851-11	CERAMIC 0.1MF 20% 16V	C383	1-162-851-11	(950:Canadian,AEP,307ESD) ...CERAMIC 0.1MF 20% 16V
C204	1-162-851-11	CERAMIC 0.1MF 20% 16V			

Ref.No.	Part No.	Description			
C384	1-162-851-11	(950:Canadian,AEP,307ESD) ...CERAMIC 0.1MF	20%	16V	
C386	1-162-851-11	CERAMIC 0.1MF	20%	16V	
C387	1-162-282-31	CERAMIC	100PF	10%	50V
C390	1-124-443-00	ELECT	100MF	20%	10V
C391	1-124-443-00	ELECT	100MF	20%	10V
C400	1-162-851-11	CERAMIC	0.1MF	20%	16V
C401	1-162-851-11	CERAMIC	0.1MF	20%	16V
C402	1-162-851-11	CERAMIC	0.1MF	20%	16V
C403	1-162-851-11	CERAMIC	0.1MF	20%	16V
C404	1-162-851-11	CERAMIC	0.1MF	20%	16V
C405	1-162-851-11	CERAMIC	0.1MF	20%	16V
C406	1-162-851-11	CERAMIC	0.1MF	20%	16V
C407	1-130-473-00	MYLAR	0.0015MF	5%	50V
C408	1-130-484-00	MYLAR	0.012MF	5%	50V
C409	1-130-480-00	MYLAR	0.0056MF	5%	50V
C410	1-130-474-00	MYLAR	0.0018MF	5%	50V
C411	1-130-471-00	MYLAR	0.001MF	5%	50V
C412	1-123-332-00	ELECT	47MF	20%	25V
C414	1-124-559-51	ELECT	1000MF	20%	10V
C450	1-124-472-11	ELECT	470MF	20%	10V
C451	1-124-472-11	ELECT	470MF	20%	10V
C452	1-162-290-31	CERAMIC	470PF	10%	50V
C500	1-162-851-11	CERAMIC	0.1MF	20%	16V
C501	1-162-851-11	CERAMIC	0.1MF	20%	16V
C502	1-162-851-11	CERAMIC	0.1MF	20%	16V
C503	1-162-851-11	CERAMIC	0.1MF	20%	16V
C504	1-162-851-11	CERAMIC	0.1MF	20%	16V
C505	1-162-851-11	CERAMIC	0.1MF	20%	16V
C506	1-162-851-11	CERAMIC	0.1MF	20%	16V
C507	1-130-473-00	MYLAR	0.0015MF	5%	50V
C508	1-130-484-00	MYLAR	0.012MF	5%	50V
C509	1-130-480-00	MYLAR	0.0056MF	5%	50V
C510	1-130-474-00	MYLAR	0.0018MF	5%	50V
C511	1-130-471-00	MYLAR	0.001MF	5%	50V
C512	1-123-332-00	ELECT	47MF	20%	25V
C514	1-124-559-51	ELECT	1000MF	20%	10V
C520	1-162-290-31	CERAMIC	470PF	10%	50V
C521	1-126-103-11	ELECT	470MF	20%	16V
C522	1-126-103-11	ELECT	470MF	20%	16V
C523	1-124-478-11	ELECT	100MF	20%	25V
C524	1-124-478-11	ELECT	100MF	20%	25V
C525	1-162-203-31	CERAMIC	15PF	5%	50V
C526	1-162-205-31	CERAMIC	18PF	5%	50V
C527	1-162-291-31	CERAMIC	560PF	10%	50V
C528	1-162-291-31	CERAMIC	560PF	10%	50V
C529	1-124-908-11	ELECT	22MF	20%	25V
C530	1-161-379-00	CERAMIC	0.01MF	20%	16V
C552	1-162-290-31	CERAMIC	470PF	10%	50V
C801	1-162-207-31	CERAMIC	22PF	5%	50V
C802	1-162-207-31	CERAMIC	22PF	5%	50V
C803	1-161-379-00	CERAMIC	0.01MF	20%	16V
C804	1-123-661-00	ELECT	100MF	20%	6.3V
C805	1-161-379-00	CERAMIC	0.01MF	20%	16V
C900	1-124-898-11	ELECT	4700MF	20%	16V
C901	1-124-473-11	ELECT	1000MF	20%	10V
C902	1-123-875-11	ELECT	10MF	20%	50V
C903	1-124-925-11	ELECT	2.2MF	20%	50V
C904	1-126-244-51	ELECT	47000MF	5.5V	
C905	1-126-103-11	ELECT	470MF	20%	16V
C906	1-123-875-11	ELECT	10MF	20%	50V
C910	1-124-898-11	ELECT	4700MF	20%	16V
C911	1-124-472-11	ELECT	470MF	20%	10V

Ref.No.	Part No.	Description			
C920	1-126-105-11	ELECT	1000MF	20%	35V
C921	1-124-360-00	ELECT	1000MF	20%	16V
C940	1-124-122-11	ELECT	100MF	20%	50V
C941	1-124-122-11	ELECT	100MF	20%	50V
C942	1-124-122-11	ELECT	100MF	20%	50V
C944	1-124-122-11	ELECT	100MF	20%	50V
C990	△.1-161-744-00	CERAMIC	0.01MF		400V
C991	△.1-161-744-00	(950:US,Canadian,307ESD:US) ...CERAMIC 0.01MF			400V
C991	△.1-162-599-12	(950:AEP)...CERAMIC 0.0047MF			400V
C992	△.1-161-744-00	(950:US,Canadian,307ESD:US) ...CERAMIC 0.01MF			400V
C992	△.1-162-599-12	(950:AEP)...CERAMIC 0.0047MF			400V
C993	△.1-161-742-00	(950:AEP)...0.0022MF	20%		400V
C994	△.1-161-742-00	(950:AEP)...0.0022MF	20%		400V
C995	△.1-161-742-00	(950:AEP)...0.0022MF	20%		400V
C996	△.1-161-742-00	(950:AEP)...0.0022MF	20%		400V
CN256	*1-564-336-51	PIN, CONNECTOR 2P			
CN258	*1-564-337-51	PIN, CONNECTOR 3P			
CN260	*1-564-704-11	PIN, CONNECTOR (SMALL TYPE) 2P			
CNJ251	1-564-720-21	PIN, CONNECTOR (SMALL TYPE) 2P			
CNP101*	*1-564-706-31	PIN, CONNECTOR (SMALL TYPE) 4P			
CNP102*	*1-564-710-11	PIN, CONNECTOR (SMALL TYPE) 8P			
CNP201*	*1-564-339-61	PIN, CONNECTOR 5P			
CNP203*	*1-564-706-11	PIN, CONNECTOR (SMALL TYPE) 4P			
CNP204*	*1-564-706-41	PIN, CONNECTOR (SMALL TYPE) 4P			
CNP302*	*1-564-340-61	PIN, CONNECTOR 6P			
CNP303*	*1-564-666-11	PIN, CONNECTOR 10P			
CNP304*	*1-564-338-71	PIN, CONNECTOR 4P			
CNP380*	*1-564-706-11	(950:Canadian,AEP,307ESD) ...PIN, CONNECTOR (SMALL TYPE) 4P			
CNP401*	*1-564-705-11	PIN, CONNECTOR (SMALL TYPE) 3P			
CNP402*	*1-564-708-11	PIN, CONNECTOR (SMALL TYPE) 6P			
CNP901*	*1-564-340-51	PIN, CONNECTOR 6P			
CP450	1-233-128-11	COMPOSITION CIRCUIT BLOCK			
CP550	1-233-128-11	COMPOSITION CIRCUIT BLOCK			
D101	8-719-940-76	DIODE 1SS132			
D201	8-719-940-76	(307ESD:US)...DIODE 1SS132			
D901	8-719-940-76	DIODE 1SS132			
D902	8-719-940-76	DIODE 1SS132			
D903	8-719-940-76	DIODE 1SS132			
D904	8-719-940-76	DIODE 1SS132			
D905	8-719-940-76	DIODE 1SS132			
D906	8-719-940-76	DIODE 1SS132			
D907	8-719-928-82	DIODE HZS4.3NB3			
D908	△.8-719-936-83	DIODE GP08DPKG23			
D909	△.8-719-936-83	DIODE GP08DPKG23			
D910	△.8-719-936-83	DIODE GP08DPKG23			
D911	△.8-719-936-83	DIODE GP08DPKG23			
D920	△.8-719-936-83	DIODE GP08DPKG23			
D921	△.8-719-936-83	DIODE GP08DPKG23			

The components identified by shading and mark  are critical for safety. Replace only with part number specified.

Les composants identifiés par une trame et une marque  sont critiques pour la sécurité. Ne les remplacer que par une pièce portant le numéro spécifié.

Ref.No.	Part No.	Description
D940	△ 8-719-936-83	DIODE GP08DPKG23
D941	△ 8-719-936-83	DIODE GP08DPKG23
D943	△ 8-719-936-83	DIODE GP08DPKG23
D944	8-719-934-26	DIODE HZS33-2L
D945	8-719-933-57	DIODE HZS9B2L
FLD801	1-519-428-11	INDICATOR TUBE, FLUORESCENT
IC101	8-752-031-80	IC CXA1081S
IC201	8-759-202-01	IC TA7256P
IC202	8-759-805-18	IC LA6520
IC203	8-759-820-04	(307ESD:US)...IC LC6523H-3446
IC204	8-752-032-33	IC CXA1182S
IC301	8-759-971-40	IC MSM6408-26SS
IC302	8-752-322-04	IC CXD1125Q
IC303	8-752-320-44	IC CXK5816M-10L
IC351	8-759-630-16	IC M50740A-424SP
IC352	8-759-820-64	IC LC9600R-183
IC380	8-759-202-11	IC TC74HC00P
IC390	8-759-962-08	IC BA6208
IC400	8-759-701-21	IC NJM5532D-D
IC450	8-759-700-74	IC NJM4556S
IC500	8-759-701-21	IC NJM5532D-D
IC520	8-759-939-35	IC CXD1088Q
IC521	8-759-939-94	IC TDA1541-N5
IC801	8-752-803-69	IC CXP5058H-068Q
IC802	8-741-138-70	IC BX-1387
IC900	8-759-604-29	IC M5F7805
IC910	8-759-604-47	IC M5F7905
IC920	8-759-604-52	IC M5F7915
IC930	8-759-604-02	IC M5278L56
IC940	8-759-001-02	IC MC74HC02N
J380	1-507-567-61	(950:Canadian,AEP,307ESD) ...JACK, PIN 1P (DIGITAL OUT)
J390	1-563-485-21	JACK, LARGE TYPE (HEADPHONES)
J401	1-566-817-11	JACK, PIN 4P (LINE OUT)
L381	*1-410-858-11	(950:Canadian,AEP,307ESD)..INDUCTOR OUH
M251	A-4608-346-A	MOTOR ASSY, L
M252	X-4917-504-1	ASSY, MOTOR (SLED)
M253	X-4917-523-1	ASSY, MOTOR (SPINDLE)
PS205A	1-532-605-00	(950:AEP,307ESD:E)...LINK, IC
PS206A	1-532-605-00	(950:AEP,307ESD:E)...LINK, IC
PS901A	1-532-675-00	(950:AEP,307ESD:E)...LINK, IC
PS911A	1-532-675-00	(950:AEP,307ESD:E)...LINK, IC
PS920A	1-532-685-00	(950:AEP,307ESD:E)...LINK, IC
Q101	8-729-103-43	TRANSISTOR 2SB734
Q202	8-729-806-28	(307ESD)...TRANSISTOR 2SC3402
Q203	8-729-806-28	(307ESD)...TRANSISTOR 2SC3402
Q204	9-986-159-01	(307ESD)...TRANSISTOR 2SA1348
Q205	8-729-806-38	TRANSISTOR 2SC3399
Q206	8-729-806-28	TRANSISTOR 2SC3402
Q301	8-729-806-38	TRANSISTOR 2SC3399
Q400	8-729-107-99	TRANSISTOR 2SC3622A-K
Q401	8-729-107-99	TRANSISTOR 2SC3622A-K
Q402	8-729-107-99	TRANSISTOR 2SC3622A-K
Q500	8-729-107-99	TRANSISTOR 2SC3622A-K
Q501	8-729-107-99	TRANSISTOR 2SC3622A-K
Q502	8-729-107-99	TRANSISTOR 2SC3622A-K
Q520	9-986-159-01	TRANSISTOR 2SA1348
Q521	9-986-159-01	TRANSISTOR 2SA1348
Q522	8-729-806-28	TRANSISTOR 2SC3402
Q801	8-729-902-11	TRANSISTOR 2SC2021
Q940	8-729-103-43	TRANSISTOR 2SB734

Ref.No.	Part No.	Description			
R101	1-215-396-00	CARBON	91	5%	1/4W
R102	1-214-092-00	METAL	22	1%	1/4W
R103	1-249-417-11	CARBON	1K	5%	1/4W
R104	1-249-433-11	CARBON	22K	5%	1/4W
R105	1-249-421-11	CARBON	2.2K	5%	1/4W
R106	1-249-428-11	CARBON	8.2K	5%	1/4W
R107	1-215-450-00	CARBON	16K	5%	1/4W
R108	1-249-425-11	CARBON	4.7K	5%	1/4W
R109	1-249-425-11	CARBON	4.7K	5%	1/4W
R110	1-249-432-11	CARBON	18K	5%	1/4W
R111	1-249-432-11	CARBON	18K	5%	1/4W
R112	1-249-441-11	CARBON	100K	5%	1/4W
R201	1-249-393-11	CARBON	10	5%	1/4W
R203	1-249-393-11	CARBON	10	5%	1/4W
R205	1-247-881-00	CARBON	120K	5%	1/4W
R206	1-215-472-00	CARBON	130K	5%	1/4W
R208	1-247-881-00	CARBON	120K	5%	1/4W
R210	1-215-472-00	CARBON	130K	5%	1/4W
R211	1-249-437-11	CARBON	47K	5%	1/4W
R212	1-249-436-11	CARBON	39K	5%	1/4W
R213	1-249-429-11	CARBON	10K	5%	1/4W
R214	1-249-423-11	CARBON	3.3K	5%	1/4W
R215	1-249-424-11	CARBON	3.9K	5%	1/4W
R216	1-249-393-11	CARBON	10	5%	1/4W
R217	1-249-438-11	CARBON	56K	5%	1/4W
R218	1-249-424-11	CARBON	3.9K	5%	1/4W
R219	1-249-424-11	CARBON	3.9K	5%	1/4W
R220	1-249-424-11	CARBON	3.9K	5%	1/4W
R222	1-215-472-00	CARBON	130K	5%	1/4W
R223	1-249-393-11	CARBON	10	5%	1/4W
R224	1-249-393-11	CARBON	10	5%	1/4W
R225	1-249-417-11	(307ESD)...CARBON	1K	5%	1/4W
R226	1-249-405-11	(307ESD)...CARRON	100	5%	1/4W
R227	1-249-429-11	(307ESD)...CARBON	10K	5%	1/4W
R228	1-215-486-00	CARBON	510K	5%	1/4W
R229	1-249-435-11	CARBON	33K	5%	1/4W
R230	1-215-479-00	CARBON	270K	5%	1/4W
R231	1-249-440-11	CARBON	82K	5%	1/4W
R232	1-249-429-11	CARBON	10K	5%	1/4W
R233	1-249-414-11	CARBON	560	5%	1/4W
R234	1-249-441-11	CARBON	100K	5%	1/4W
R235	1-215-434-00	METAL	3.6K	1%	1/6W
R236	1-249-433-11	CARBON	22K	5%	1/4W
R237	1-249-441-11	CARBON	100K	5%	1/4W
R301	1-249-405-11	CARBON	100	5%	1/4W
R302	1-249-441-11	CARBON	100K	5%	1/4W
R303	1-215-469-00	METAL	100K	1%	1/6W
R304	1-215-469-00	METAL	100K	1%	1/6W
R305	1-249-429-11	CARBON	10K	5%	1/4W
R306	1-249-441-11	CARBON	100K	5%	1/4W
R307	1-249-429-11	CARBON	10K	5%	1/4W

The components identified by shading and mark  are critical for safety. Replace only with part number specified.

Les composants identifiés par une trame et une marque  sont critiques pour la sécurité. Ne les remplacer que par une pièce portant le numéro spécifié.

Ref.No.	Part No.	Description			
R308	1-249-417-11	CARBON	1K	5%	1/4W
R309	1-249-433-11	CARBON	22K	5%	1/4W
R310	1-215-493-00	CARBON	1M	5%	1/4W
R311	1-249-425-11	CARBON	4.7K	5%	1/4W
R380	1-215-394-00	(950:Canadian,AEP,307ESD) ...CARBON 75	5%		1/4W
R381	1-249-405-11	(950:Canadian,AEP,307ESD) ...CARBON 100	5%		1/4W
R382	1-249-417-11	CARBON	1K	5%	1/4W
R383	1-249-429-11	CARBON	10K	5%	1/4W
R384	1-249-429-11	CARBON	10K	5%	1/4W
R390	1-249-433-11	CARBON	22K	5%	1/4W
R391	1-249-433-11	CARBON	22K	5%	1/4W
R400	1-247-138-00	CARBON	2K	5%	1/4W
R401	1-247-714-11	CARBON	1.2K	5%	1/4W
R402	1-246-545-00	CARBON	1M	5%	1/4W
R403	1-249-425-11	CARBON	4.7K	5%	1/4W
R404	1-247-718-11	CARBON	2.7K	5%	1/4W
R405	1-247-718-11	CARBON	2.7K	5%	1/4W
R406	1-246-533-00	CARBON	330K	5%	1/4W
R407	1-247-704-11	CARBON	220	5%	1/4W
R408	1-247-710-11	CARBON	560	5%	1/4W
R409	1-249-417-11	CARBON	1K	5%	1/4W
R410	1-247-710-11	CARBON	560	5%	1/4W
R411	1-247-710-11	CARBON	560	5%	1/4W
R412	1-249-417-11	CARBON	1K	5%	1/4W
R413	1-247-704-11	CARBON	220	5%	1/4W
R414	1-247-710-11	CARBON	560	5%	1/4W
R450	1-249-435-11	CARBON	33K	5%	1/4W
R451	1-249-432-11	CARBON	18K	5%	1/4W
R453	1-249-402-11	CARBON	56	5%	1/4W
R500	1-247-138-00	CARBON	2K	5%	1/4W
R501	1-247-714-11	CARBON	1.2K	5%	1/4W
R502	1-246-545-00	CARBON	1M	5%	1/4W
R503	1-249-425-11	CARBON	4.7K	5%	1/4W
R504	1-247-718-11	CARBON	2.7K	5%	1/4W
R505	1-247-718-11	CARBON	2.7K	5%	1/4W
R506	1-246-533-00	CARBON	330K	5%	1/4W
R507	1-247-704-11	CARBON	220	5%	1/4W
R508	1-247-710-11	CARBON	560	5%	1/4W
R509	1-249-417-11	CARBON	1K	5%	1/4W
R510	1-247-710-11	CARBON	560	5%	1/4W
R511	1-247-710-11	CARBON	560	5%	1/4W
R512	1-249-417-11	CARBON	1K	5%	1/4W
R513	1-247-704-11	CARBON	220	5%	1/4W
R514	1-247-710-11	CARBON	560	5%	1/4W
R520	1-249-441-11	CARBON	100K	5%	1/4W
R521	1-249-441-11	CARBON	100K	5%	1/4W
R524	1-249-417-11	CARBON	1K	5%	1/4W
R525	1-249-413-11	CARBON	470	5%	1/4W
R526	1-249-413-11	CARBON	470	5%	1/4W
R527	1-249-413-11	CARBON	470	5%	1/4W
R550	1-249-435-11	CARBON	33K	5%	1/4W
R551	1-249-432-11	CARBON	18K	5%	1/4W
R553	1-249-402-11	CARBON	56	5%	1/4W
R801	1-249-422-11	CARBON	2.7K	5%	1/4W
R802	1-249-422-11	CARBON	2.7K	5%	1/4W
R803	1-249-422-11	CARBON	2.7K	5%	1/4W
R804	1-249-422-11	CARBON	2.7K	5%	1/4W
R805	1-249-422-11	CARBON	2.7K	5%	1/4W
R806	1-249-422-11	CARBON	2.7K	5%	1/4W
R807	1-249-422-11	CARBON	2.7K	5%	1/4W
R808	1-249-422-11	CARBON	2.7K	5%	1/4W
R809	1-249-424-11	CARBON	3.9K	5%	1/4W
R810	1-249-424-11	CARBON	3.9K	5%	1/4W

Ref.No.	Part No.	Description			
R811	1-249-424-11	CARBON	3.9K	5%	1/4W
R812	1-249-424-11	CARBON	3.9K	5%	1/4W
R813	1-249-424-11	CARBON	3.9K	5%	1/4W
R814	1-249-424-11	CARBON	3.9K	5%	1/4W
R815	1-249-424-11	CARBON	3.9K	5%	1/4W
R816	1-249-424-11	CARBON	3.9K	5%	1/4W
R817	1-249-427-11	CARBON	6.8K	5%	1/4W
R818	1-249-427-11	CARBON	6.8K	5%	1/4W
R819	1-249-427-11	CARBON	6.8K	5%	1/4W
R820	1-249-427-11	CARBON	6.8K	5%	1/4W
R821	1-249-427-11	CARBON	6.8K	5%	1/4W
R822	1-249-427-11	CARBON	6.8K	5%	1/4W
R823	1-249-427-11	CARBON	6.8K	5%	1/4W
R824	1-249-427-11	CARBON	6.8K	5%	1/4W
R825	1-249-432-11	CARBON	18K	5%	1/4W
R826	1-249-432-11	CARBON	18K	5%	1/4W
R827	1-249-432-11	CARBON	18K	5%	1/4W
R828	1-249-432-11	CARBON	18K	5%	1/4W
R829	1-249-432-11	CARBON	18K	5%	1/4W
R830	1-249-432-11	CARBON	18K	5%	1/4W
R831	1-249-432-11	CARBON	18K	5%	1/4W
R832	1-249-432-11	CARBON	18K	5%	1/4W
R833	1-249-429-11	CARBON	10K	5%	1/4W
R834	1-249-429-11	CARBON	10K	5%	1/4W
R835	1-249-429-11	CARBON	10K	5%	1/4W
R836	1-249-429-11	CARBON	10K	5%	1/4W
R837	1-249-429-11	CARBON	10K	5%	1/4W
R838	1-249-429-11	CARBON	10K	5%	1/4W
R839	1-249-441-11	CARBON	100K	5%	1/4W
R840	1-249-429-11	CARBON	10K	5%	1/4W
R841	1-249-429-11	CARBON	10K	5%	1/4W
R842	1-249-429-11	CARBON	10K	5%	1/4W
R843	1-249-429-11	CARBON	10K	5%	1/4W
R844	1-249-429-11	CARBON	10K	5%	1/4W
R845	1-249-429-11	CARBON	10K	5%	1/4W
R846	1-249-429-11	CARBON	10K	5%	1/4W
R847	1-249-429-11	CARBON	10K	5%	1/4W
R848	1-249-429-11	CARBON	10K	5%	1/4W
R900	1-249-520-11	CARBON	47	5%	1/4W
R901	1-249-417-11	CARBON	1K	5%	1/4W
R902	1-247-887-00	CARBON	220K	5%	1/4W
R903	1-249-405-11	CARBON	100	5%	1/4W
R904	1-247-708-11	CARBON	470	5%	1/4W
R920	1-249-516-11	CARBON	33	5%	1/4W
R930	1-249-516-11	CARBON	33	5%	1/4W
R940	△1-217-399-00	FUSIBLE	33	5%	1/4W
R941	1-249-424-11	CARBON	3.9K	5%	1/4W
R942	1-249-433-11	CARBON	22K	5%	1/4W
R943	1-249-429-11	CARBON	10K	5%	1/4W
R944	1-249-437-11	CARBON	47K	5%	1/4W
R945	1-247-891-00	CARBON	330K	5%	1/4W

The components identified by shading and mark  are critical for safety. Replace only with part number specified.

Les composants identifiés par une trame et une marque  sont critiques pour la sécurité. Ne les remplacer que par une pièce portant le numéro spécifié.

Ref.No.	Part No.	Description	Ref.No.	Part No.	Description
RV101	1-228-995-00	RES, ADJ, METAL GLAZE 22K	S837	1-554-303-21	SWITCH, KEY BOARD (OPEN/CLOSE)
RV102	1-237-194-11	RES, ADJ, CARBON 20K	S838	1-554-303-21	SWITCH, KEY BOARD (AUTO SPACE)
RV103	1-237-194-11	RES, ADJ, CARBON 20K	S839	1-554-303-21	SWITCH, KEY BOARD (REPEAT)
RV104	1-228-993-00	RES, ADJ, METAL GLAZE 4.7K	S840	1-554-303-21	SWITCH, KEY BOARD (INDEX ←)
RV201	1-228-990-00	RES, ADJ, METAL GLAZE 1K	S841	1-554-303-21	SWITCH, KEY BOARD (▶)
RV450	1-237-917-31	RES, VAR, CARBON 10K/10K	S842	1-554-303-21	SWITCH, KEY BOARD (⏏)
S251	1-571-300-11	SWITCH, ROTARY (LOADING IN/OUT)	S843	1-554-481-00	SWITCH, SLIDE (TIMER)
S252	1-571-274-11	SWITCH, LEAF (LIMIT IN)	S990	▲1-553-318-00	SWITCH, PUSH (POWER)
S380	1-571-083-11	(950:Canadian,AEP,307ESD) ...SWITCH, SLIDE (OUTPUT SELECTOR)	S991	▲1-526-576-11	(307ESD:E)...SELECTOR, POWER VOLTAGE (VOLTAGE SELECTOR)
S801	1-554-303-21	SWITCH, KEY BOARD (1,A)	T380	1-421-946-11	(950:Canadian,AEP,307ESD) ...TRANSFORMER, PULSE
S802	1-554-303-21	SWITCH, KEY BOARD (2,B)	T990	▲1-449-029-11	(950:US,Canadian,307ESD:US) ...TRANSFORMER, POWER
S803	1-554-303-21	SWITCH, KEY BOARD (3,C)	T990	▲1-449-030-11	(950:AEP)...TRANSFORMER, POWER
S804	1-554-303-21	SWITCH, KEY BOARD (4,D)	T990	▲1-449-031-11	(307ESD:E)...TRANSFORMER, POWER
S805	1-554-303-21	SWITCH, KEY BOARD (5,E)	T991	1-421-960-11	TRANSFORMER, LINE FILTER
S806	1-554-303-21	SWITCH, KEY BOARD (6,F)	X301	1-567-686-11	OSCILLATOR, CERAMIC, 4MHz
S807	1-554-303-21	SWITCH, KEY BOARD (7)	X520	1-567-926-11	VIBRATOR, CRYSTAL, 16.9344MHz
S808	1-554-303-21	SWITCH, KEY BOARD (8)	X801	1-567-192-11	OSCILLATOR, CERAMIC, 4MHz
S809	1-554-303-21	SWITCH, KEY BOARD (9)			
S810	1-554-303-21	SWITCH, KEY BOARD (10)			
S811	1-554-303-21	SWITCH, KEY BOARD (11)			
S812	1-554-303-21	SWITCH, KEY BOARD (12)			
S813	1-554-303-21	SWITCH, KEY BOARD (13)			
S814	1-554-303-21	SWITCH, KEY BOARD (14)			
S815	1-554-303-21	SWITCH, KEY BOARD (15)			
S816	1-554-303-21	SWITCH, KEY BOARD (16)			
S817	1-554-303-21	SWITCH, KEY BOARD (17)			
S818	1-554-303-21	SWITCH, KEY BOARD (18)			
S819	1-554-303-21	SWITCH, KEY BOARD (19)			
S820	1-554-303-21	SWITCH, KEY BOARD (20)			
S821	1-554-303-21	SWITCH, KEY BOARD (▶▶)			
S822	1-554-303-21	SWITCH, KEY BOARD (ERASE)			
S823	1-554-303-21	SWITCH, KEY BOARD (COUNTINUE)			
S824	1-554-303-21	SWITCH, KEY BOARD (SHUFFLE)			
S825	1-554-303-21	SWITCH, KEY BOARD (PROGRAM)			
S826	1-554-303-21	SWITCH, KEY BOARD (>20)			
S827	1-554-303-21	SWITCH, KEY BOARD (CHECK)			
S828	1-554-303-21	SWITCH, KEY BOARD (CLEAR)			
S829	1-554-303-21	SWITCH, KEY BOARD (FILE)			
S830	1-554-303-21	SWITCH, KEY BOARD (CUSTOM INDEX MODE)			
S831	1-554-303-21	SWITCH, KEY BOARD (INDEX ←)			
S832	1-554-303-21	SWITCH, KEY BOARD (■)			
S833	1-554-303-21	SWITCH, KEY BOARD (AMS ◀◀)			
S834	1-554-303-21	SWITCH, KEY BOARD (AMS ▶▶)			
S835	1-554-303-21	SWITCH, KEY BOARD (◀◀)			
S836	1-554-303-21	SWITCH, KEY BOARD (DISPLAY)			

ACCESSORY & PACKING MATERIAL

1-463-909-11	COMMANDER, REMOTE (RM-D650)
1-558-543-11	CORD, CONNECTION
3-703-390-01	(307ESD:US,950:US)...INSTRUCTION
3-769-608-11	(950:Canadian,AEP,307ESD:E) ...MANUAL, INSTRUCTION
3-769-608-21	(307ESD:US)...MANUAL, INSTRUCTION
3-769-608-41	(950:AEP)...MANUAL, INSTRUCTION
3-769-608-51	(950:US)...MANUAL, INSTRUCTION
4-922-517-11	(950)...INDIVIDUAL CARTON
4-922-517-21	(307ESD)...INDIVIDUAL CARTON
4-922-528-01	LID, BATTERY CASE, COMMANDER
*4-922-581-01	CUSHION

The components identified by shading and mark  are critical for safety. Replace only with part number specified.

Les composants identifiés par une trame et une marque  sont critiques pour la sécurité. Ne les remplacer que par une pièce portant le numéro spécifié.

SONY COMPACT DISC PLAYER CDP-307ESD/950

- Note:
- All capacitors are in μF unless otherwise noted. pF : μF
 - 50WV or less are not indicated except for electrolytics and tantalums.
 - All resistors are in Ω and $1/4\text{W}$ or less unless otherwise specified.
 - \triangle : internal component.
 - : fusible resistor.

Note: The components identified by shading and mark \triangle are critical for safety. Replace only with part number specified.

Note: Les composants identifiés par un tramé et une marque \triangle sont critiques pour la sécurité. Ne les remplacer que par une pièce portant le numéro spécifié.

- : B+ bus.
- : B- bus.
- : adjustment for repair.
- Voltage and waveforms are dc with respect to ground under no-signal conditions.
- no mark: STOP
- : PLAY
- : DIGITAL OUT SWITCH ON
- Voltages are taken with a VOM (50 k Ω /V).
- Voltage variations may be noted due to normal production tolerances.
- Waveforms are taken with an oscilloscope.
- Voltage variations may be noted due to normal production tolerances.
- Signal path.
- : CD
- : digital out

e Switch

Ref. No.	Switch	Position	Ref. I
S251	LOADING IN/OUT	IN	S81
S252	LIMIT IN SW	OFF	S81
S380	OUTPUT SELECTOR	OFF	S81
S801	1. A	OFF	S81
S802	2. B	OFF	S81
S803	3. C	OFF	S81
S804	4. D	OFF	S81
S805	5. E	OFF	S81
S806	6. F	OFF	S82
S807	7	OFF	S82
S808	8	OFF	S82
S809	9	OFF	S82
S810	10	OFF	S82
S811	11	OFF	S82

1 2 3 4 5 6 7 8 9 10 11 12 13 14 15 16

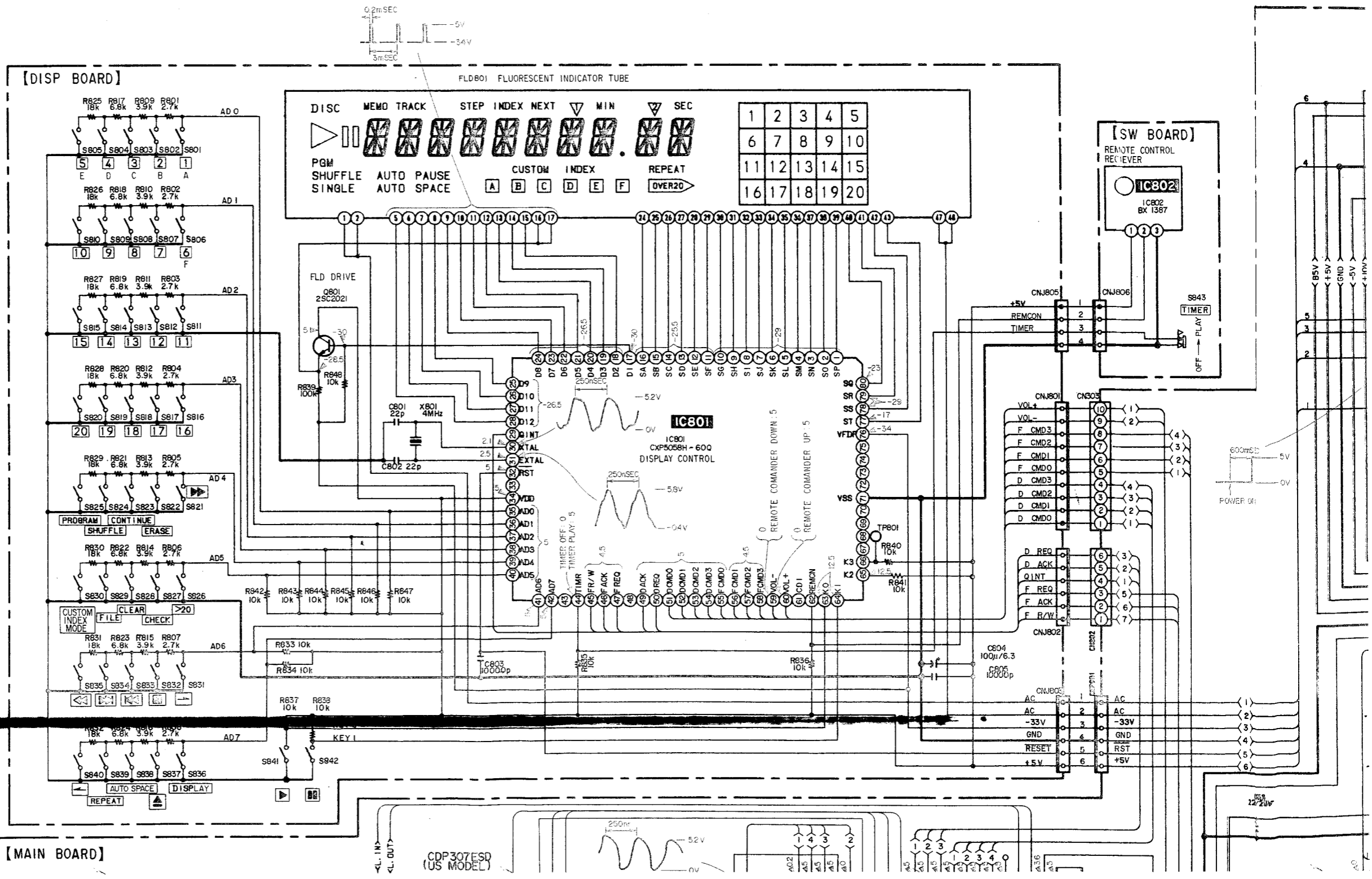

[[IN/OUT SW BOARD]]

[[TRANS RATION BOARD]]
5 BOARD

[[MAIN BOARD]]

CDP307ESD
(US MODEL)

No.	Switch	Position
51	LOADING IN/OUT	IN
52	LIMIT IN SW	OFF
30	OUTPUT SELECTOR	OFF
01	1. A	OFF
02	2. B	OFF
03	3. C	OFF
04	4. D	OFF
05	5. E	OFF
06	6. F	OFF
07	7	OFF
08	8	OFF
09	9	OFF
10	10	OFF
11	11	OFF

Ref. No.	Switch	Position
S812	12	OFF
S813	13	OFF
S814	14	OFF
S815	15	OFF
S816	16	OFF
S817	17	OFF
S818	18	OFF
S819	19	OFF
S820	20	OFF
S821	▶▶	OFF
S822	ERASE	OFF
S823	CONTINUE	OFF
S824	SHUFFLE	OFF
S825	PROGRAM	OFF

Ref. No.	Switch	Position
S826	>20	OFF
S827	CHECK	OFF
S828	CLEAR	OFF
S829	FILE	OFF
S830	CUSTOM INDEX MODE	OFF
S831	INDEX →	OFF
S832	■	OFF
S833	AMS ◀◀	OFF
S834	AMS ▶▶	OFF
S835	◀◀	OFF
S836	DISPLAY	OFF
S837	OPEN/CLOSE	CLOSE
S838	AUTO SPACE	OFF
S839	REPEAT	OFF

Ref. No.	Switch	Position
S840	INDEX ←	OFF
S841	▶	OFF
S842		OFF
S843	TIMER	OFF
S990	POWER	OFF
S991	VOLTAGE SELECTOR	—

14 15 16 17 18 19 20 21 22 23 24 25 26 27 28 29

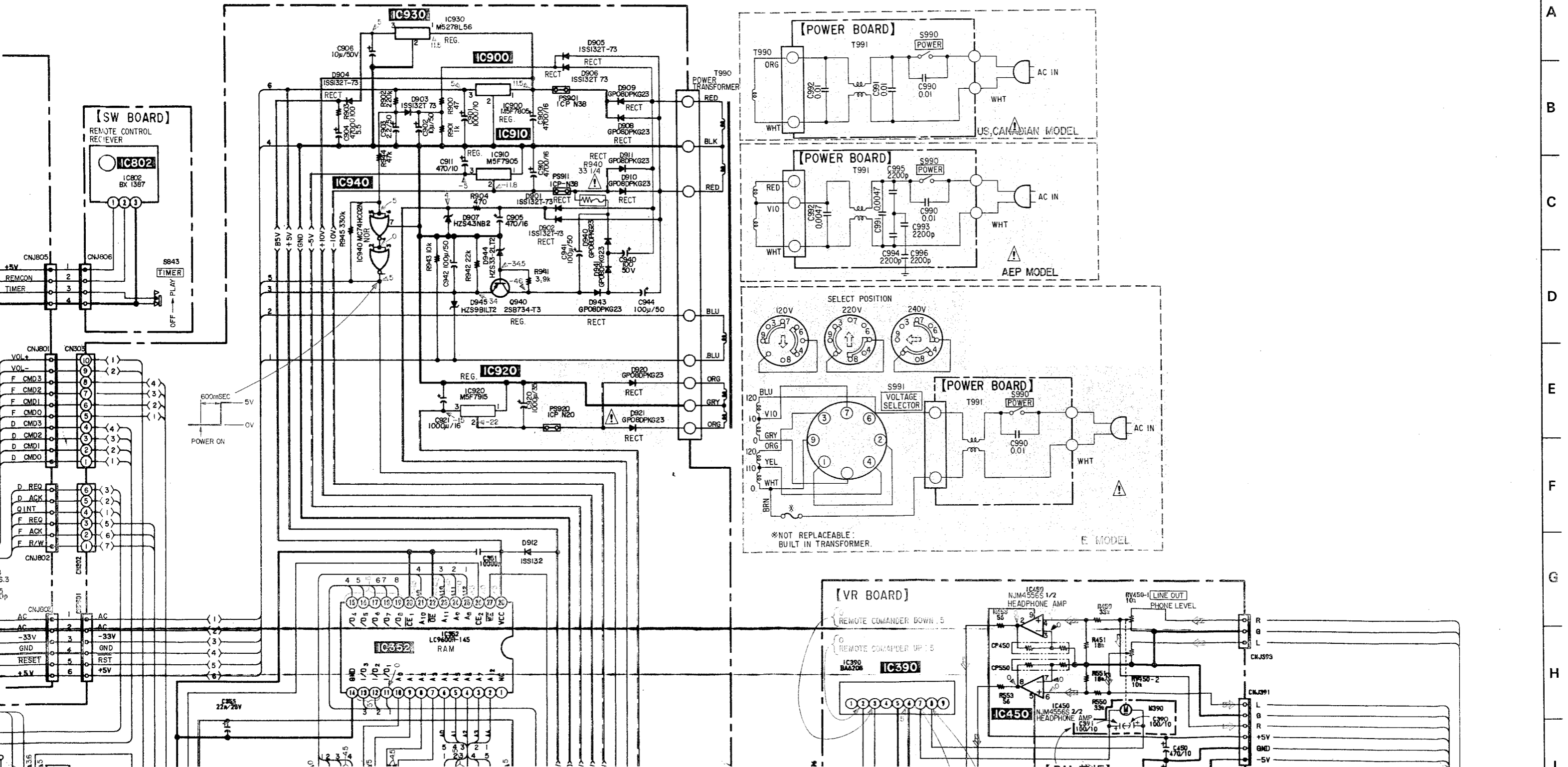

A
B
C
D
E
F
G
H

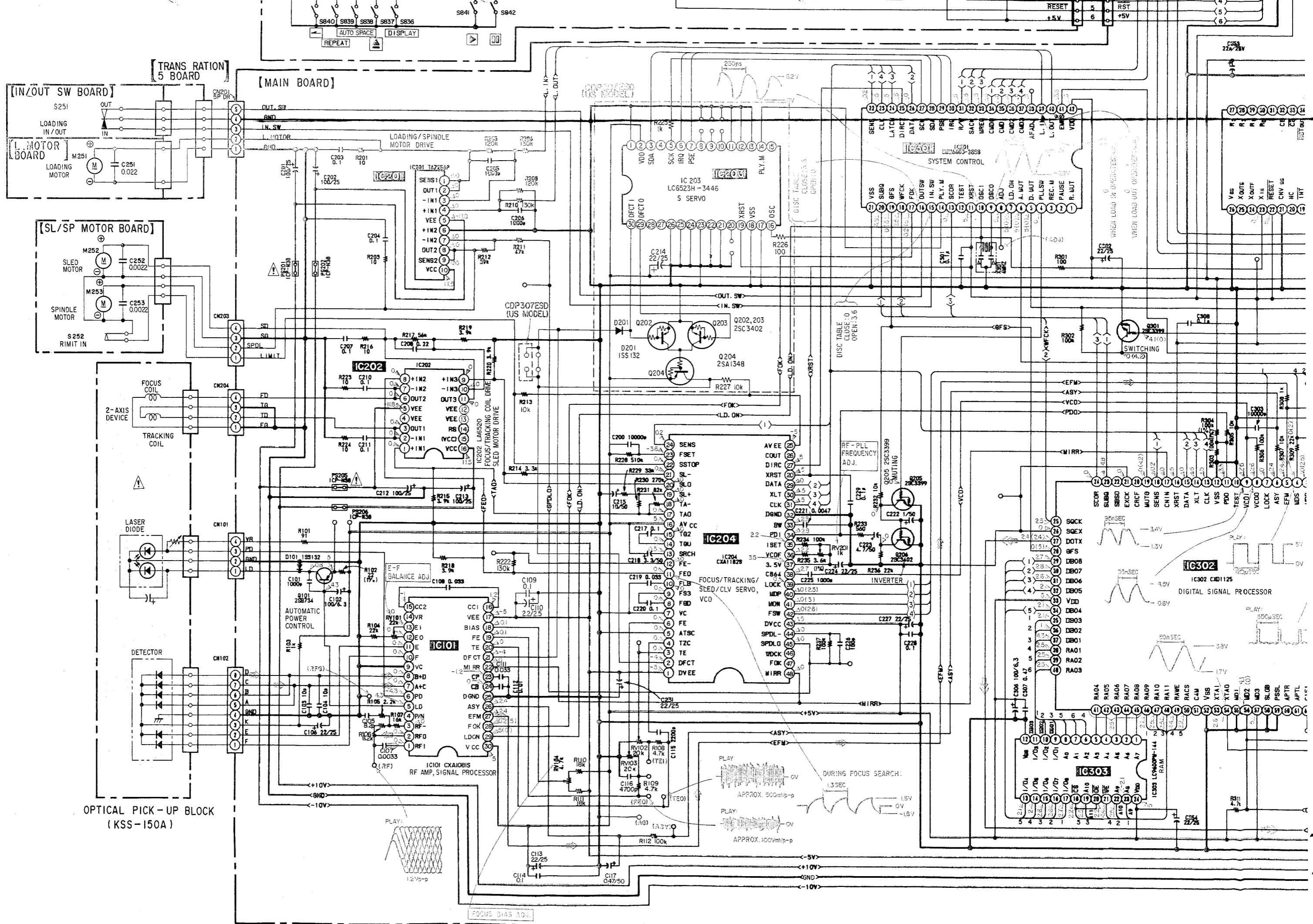

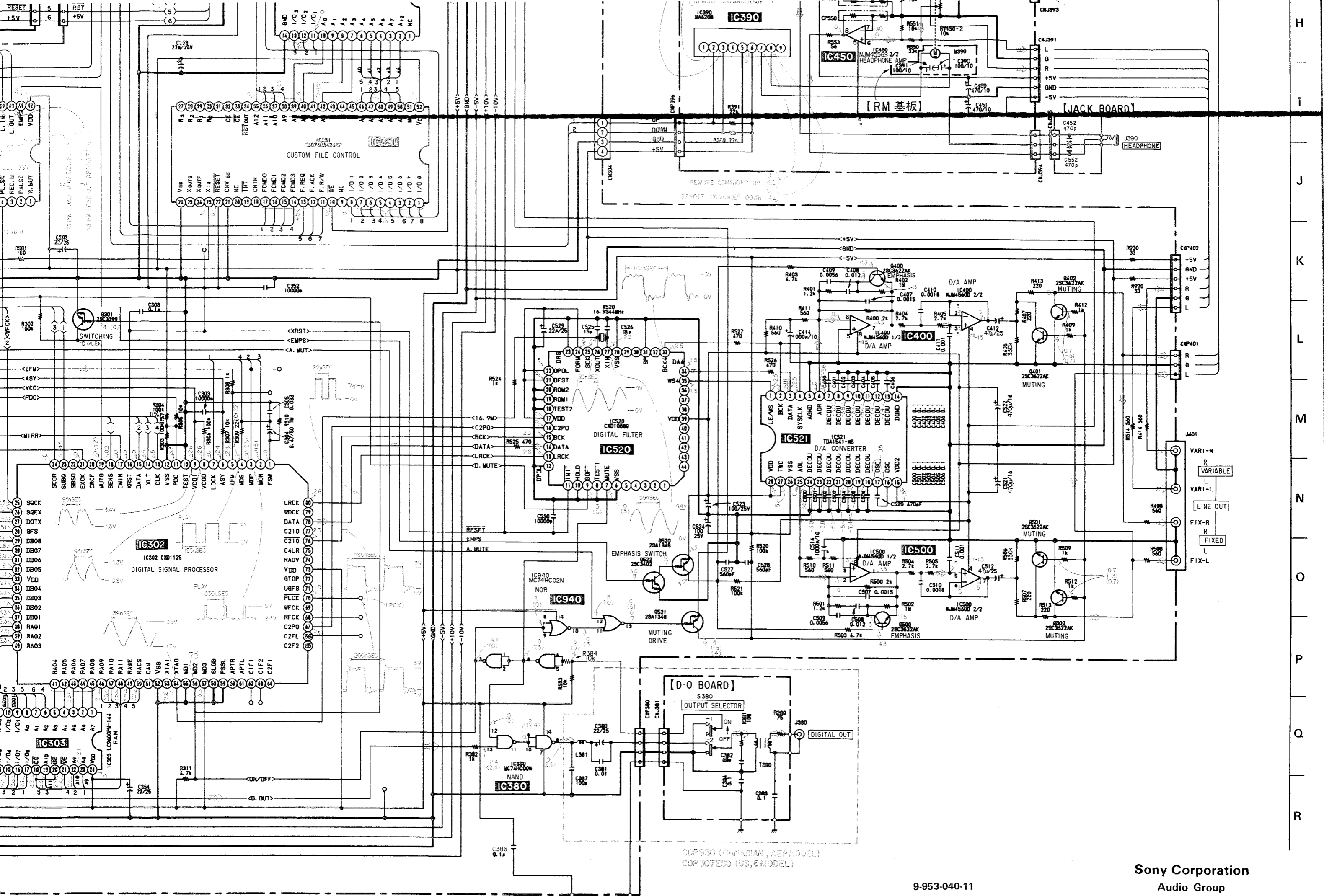

CDP950 (CANADIAN, AEP MODEL)
 CDP307ESD (US, E MODEL)