

Service Manual

PIONEER
The Art of Entertainment



ORDER NO.
RRV1471

STEREO CD CASSETE DECK RECEIVER

XR-P160

THIS MANUAL IS APPLICABLE TO THE FOLLOWING MODEL(S) AND TYPE(S).

Type	Model	Power Requirement	The voltage can be converted by the following method.
	XR-P160		
NVXK	○	AC230V	_____
MYIXK	○	AC220-230V	_____
MYXK/EA	○	AC220-230V	_____
MYXK/EB	○	AC220-230V	_____
DD	○	AC110-127V/220-230V/240V	With the voltage selector

CONTENTS

1. SAFETY INFORMATION	3	6. IC INFORMATION	62
2. EXPLODED VIEWS, PACKING AND PARTS LIST	4	7. FL INFORMATION	65
3. SCHEMATIC AND PCB CONNECTION DIAGRAMS	17	8. BLOCK DIAGRAM	67
4. PCB PARTS LIST	42	9. DISASSEMBLY	68
5. ADJUSTMENTS.....	51	10. PANEL FACILITIES	69
		11. SPECIFICATIONS	72

PIONEER ELECTRONIC CORPORATION 4-1, Meguro 1-Chome, Meguro-ku, Tokyo 153, Japan
PIONEER ELECTRONICS SERVICE, INC. P.O. Box 1760, Long Beach, CA 90801-1760, U.S.A.
PIONEER ELECTRONIC (EUROPE) N.V. Haven 1087, Keetberglaan 1, 9120 Melsele, Belgium
PIONEER ELECTRONICS ASIACENTRE PTE. LTD. 501 Orchard Road, #10-00 Lane Crawford Place, Singapore 0923

© PIONEER ELECTRONIC CORPORATION 1996

T-DFG FEB. 1996 Printed in Japan

1. SAFETY INFORMATION

(FOR EUROPEAN MODEL ONLY)

VARO!
AVATTAESSA JA SUOJALUKITUS
OHITETTAESSA OLET ALTTIINA
NÄKYMÄTTÖMÄLLE LASERSÄTEILYLLE.
ÄLÄ KATSO SÄTEESEEN.



LASER
Kuva 1
Lasersäteilyn
varoituserkki

WARNING!
DEVICE INCLUDES LASER DIODE WHICH
EMITS INVISIBLE INFRARED RADIATION
WHICH IS DANGEROUS TO EYES. THERE IS
A WARNING SIGN ACCORDING TO PICTURE
1 INSIDE THE DEVICE CLOSE TO THE LASER
DIODE.



LASER
Picture 1
Warning sign for
laser radiation

ADVERSEL:
USYNLIG LASERSTRÅLING VED ÅBNING
NÅR SIKKERHEDSAFBRYDERE ER UDE AF
FUNKTION UNGDÅ UDSAETTELSE FOR
STRÅLING.

VARNING!
OSYNLIG LASERSTRÅLNING NÅR DENNA
DEL ÄR ÖPPNAD OCH SPÄRREN
ÄR URKOPPLAD. BETRAKTA EJ STRÅLEN.

IMPORTANT
THIS PIONEER APPARATUS CONTAINS
LASER OF CLASS 1.
SERVICING OPERATION OF THE APPARATUS
SHOULD BE DONE BY A SPECIALLY
INSTRUCTED PERSON.

LASER DIODE CHARACTERISTICS
MAXIMUM OUTPUT POWER: 5 mw
WAVELENGTH: 780 - 785 nm

LABEL CHECK

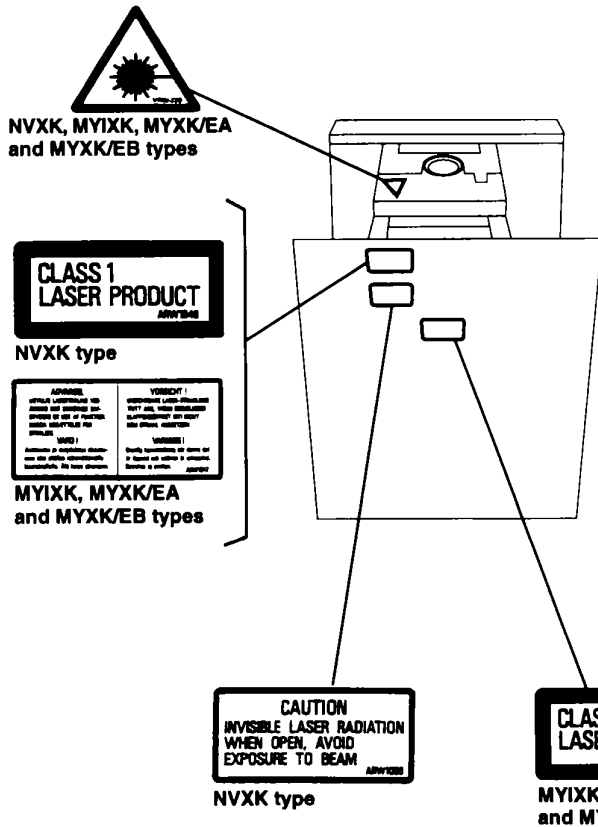

Additional Laser Caution

- Laser Interlock Mechanism**
The position of the switch (S651) for detecting loading state is detected by the system microprocessor, and the design prevents laser diode oscillation when the switch (S651) is not on CLMP terminal side (CLMP signal is OFF or high level.) Thus, the interlock will no longer function if the switch (S651) is deliberately set to CLMP terminal side. (low level)
The interlock also does not function in the test mode*. Laser diode oscillation will continue, if pin 1 of M51593FP (IC101) on the PRE-AMP BOARD ASSY mounted on the pickup assembly is connected to GND, or pin 19 is connected to low level (ON), or else the terminals of Q101 are shorted to each other (fault condition).
- When the cover is opened, close viewing of the objective lens with the naked eye will cause exposure to a Class 1 laser beam.

* Refer to page 58.

2. EXPLODED VIEWS, PACKING AND PARTS LIST

NOTES :

- Parts marked by "NSP" are generally unavailable because they are not in our Master Spare Parts List.
- The i mark found on some component parts indicates the importance of the safety factor of the part. Therefore, when replacing, be sure to use parts of identical designation.
- Parts marked by "●" are not always kept in stock. Their delivery time may be longer than usual or they may be unavailable.

2.1 PACKING

■ Contrast of XR-P160/NVXK, MYIXK, MYXK/EA, MYXK/EB and DD

XR-P160/NVXK, MYIXK, MYXK/EA, MYXK/EB and DD have the same construction except for the following:

Mark	No.	Description	Part No.					Remarks
			NVXK	MYIXK	MYXK/EA	MYXK/EB	DD	
	1	Front pad	AHA7110	AHA7110	AHA7110	AHA7110	AHA7106	
	2	Rear pad	AHA7111	AHA7111	AHA7111	AHA7111	AHA7107	
	3	Packing case	AHD7244	AHD7245	AHD7245	AHD7245	AHD7242	
	4	Packing sheet	AHG7001	AHG7001	AHG7001	AHG7001	AHG7003	
	6	FM antenna assy	ADH1019	ADH1019	ADH1019	ADH1019	Not used	
	6	FM antenna	Not used	Not used	Not used	Not used	ADH1016	
	7	Operating instructions (English)	ARB7062	Not used	Not used	ARB7062	Not used	
	7	Operating instructions (German/Italian)	Not used	ARC7094	ARC7094	Not used	Not used	
	7	Operating instructions (French/Dutch)	Not used	Not used	ARC7095	Not used	Not used	
	7	Operating instructions (French/Swedish/Spanish/Portuguese)	Not used	Not used	Not used	ARC7096	Not used	
	7	Operating instructions (English/Spanish/Chinese)	Not used	Not used	Not used	Not used	ARE7058	
	9	Loop antenna assy	ATB7002	ATB7002	ATB7002	ATB7002	ATB7004	
NSP	12	Battery (R03, AAA)	PEM1004	PEM1004	PEM1004	PEM1004	VEM-022	
NSP	13	Vinyl bag	AHG1091	AHG1091	AHG1091	AHG1091	Not used	
	13	Vinyl bag (0.03 × 230 × 340)	Not used	Not used	Not used	Not used	Z21-038	
	14	Spacer	AHB7013	Not used	Not used	Not used	Not used	
	15	Speaker specification table	ARX7012	ARX7012	ARX7012	ARX7012	Not used	

■ Parts List for XR-P160/NVXK

Mark	No.	Description	Parts No.
	1	FRONT PAD	AHA7110
	2	REAR PAD	AHA7111
	3	PACKING CASE	AHD7244
	4	PACKING SHEET	AHG7001
	5	
	6	FM ANTENNA ASSY	ADH1019
	7	OPERATING INSTRUCTIONS (English)	ARB7062
	8	
	9	LOOP ANTENNA ASSY	ATB7002
	10	REMOTE CONTROL UNIT (CU-XR015)	AXD7030
NSP	11	BATTERY LID	AZA7050
NSP	12	BATTERY (R03, AAA)	PEM1004
NSP	13	VINYL BAG	AHG1091
	14	SPACER	AHB7013
	15	SPEAKER SPECIFICATION TABLE	ARX7012

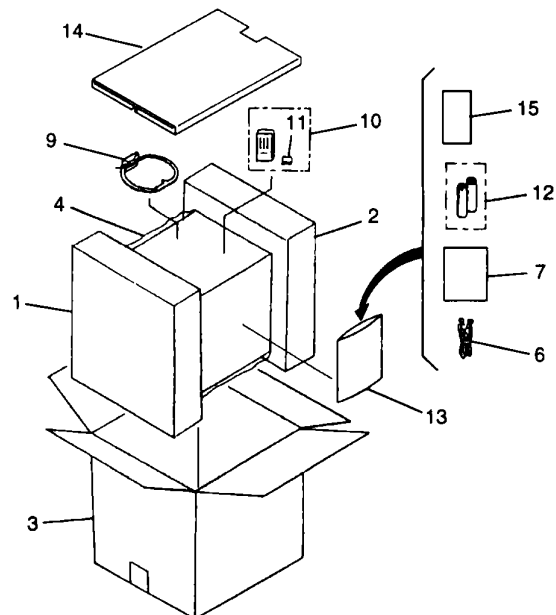

2.2 EXTERIOR
■ Contrast of XR-P160/NVXK, MYKKE, MYXK/EA, MYXK/EB and DD
 XR-P160/NVXK, MYKKE, MYXK/EA, MYXK/EB and DD have the same construction except for the following:

Mark	No.	Description	Part No.				Remarks
			MYKKE	MYKKE	MYXK/EA	MYXK/EB	
	1	SFC Assy	AVZ2111	AVZ2111	AVZ2111	AVZ2110	
	2	Screw	CS2309087ZK	CS2309087ZK	CS2309087ZK	CS2309087ZK	
	3	Pin, amy	AVZ2123	AVZ2123	AVZ2123	AVZ2121	
	4	Power transformer (AC 220-230V, T1)	AVZ1907	AVZ1907	AVZ1907	AVZ1906	
	5	Power transformer (DC 115-27V/220-230V/240V, T1)	Not used	Not used	Not used	Not used	
	6	Capacitor	AVX1706	AVX1706	AVX1706	AVX1705	
	7	Bracket case	4ZNT7345	4ZNT7345	4ZNT7345	4ZNT7316	
	8	PCB Assy	AVZ2119	AVZ2119	AVZ2119	AVZ2118	
	9	Sub seat unit	AVZ1941	AVZ1941	AVZ1941	AVZ1940	
	10	Transistor holder	AVZ1984	AVZ1984	AVZ1984	AVZ1979	
	11	VOL. amy	AVZ2109	AVZ2109	AVZ2109	AVZ2108	
	12	AF amy	AVZ2107	AVZ2107	AVZ2107	AVZ2106	
	13	CD holder L	AVZ1982	AVZ1982	AVZ1982	AVZ1977	
	14	CD holder R	AVZ1983	AVZ1983	AVZ1983	AVZ1978	
	15	Beam panel	AVZ1929	AVZ1929	AVZ1929	AVZ1927	
	16	FM/AM tuner module	AXQ2314	AXQ2314	AXQ2314	AXQ2312	
	17	AC power cord	ADG1138	ADG1138	ADG1138	ADG1013	
	18	Caution label (G)	AVW-229	AVW-229	AVW-229	Not used	
	19	Caution label (F)	AVW1046	AVW1046	AVW1046	Not used	
	20	Caution label (E)	AVW1047	AVW1047	AVW1047	Not used	
	21	Caution label (D)	AVW1048	AVW1048	AVW1048	Not used	
	22	Caution label (C)	AVW1049	AVW1049	AVW1049	Not used	
	23	Caution label (B)	AVW1050	AVW1050	AVW1050	Not used	
	24	Caution label (A)	AVW1051	AVW1051	AVW1051	Not used	
	25	Caution label (H)	AVW-229	AVW-229	AVW-229	Not used	
	26	Caution label (I)	AVW-229	AVW-229	AVW-229	Not used	
	27	Caution label (J)	AVW-229	AVW-229	AVW-229	Not used	
	28	Caution label (K)	AVW-229	AVW-229	AVW-229	Not used	
	29	Caution label (L)	AVW-229	AVW-229	AVW-229	Not used	
	30	Caution label (M)	AVW-229	AVW-229	AVW-229	Not used	
	31	Caution label (N)	AVW-229	AVW-229	AVW-229	Not used	
	32	Caution label (O)	AVW-229	AVW-229	AVW-229	Not used	
	33	Caution label (P)	AVW-229	AVW-229	AVW-229	Not used	
	34	Caution label (Q)	AVW-229	AVW-229	AVW-229	Not used	
	35	Caution label (R)	AVW-229	AVW-229	AVW-229	Not used	

■ Parts List for XR-P160/NVXK

Mark No.	Description	Part No.	Mark No.	Description	Part No.
1	SFC ASSY	AVZ2111	17	VOL. ASSY	AVZ2109
2	SCREW	CS2309087ZK	18	AF ASSY (FM/AM)	AVZ2107
3	PISTON (SIGNAL FLU)	AVZ1907	19	CD HOLDER L	AVZ1982
4	SCREW	AVZ1907	20	CD HOLDER R	AVZ1983
5	SCREW	AVZ1907	21	CD HOLDER R	AVZ1983
6	CAPACITOR	AVX1706	22	FM/AM TUNER MODULE	AXQ2314
7	SCREW	AVZ2119	23	AC POWER CORD	ADG1138
8	POWER TRANSFORMER (AC 220-230V, T1)	AVZ1907	24	AC POWER CORD	ADG1138
9	POWER TRANSFORMER (DC 115-27V/220-230V/240V, T1)	Not used	25	STRAP-IN RELIEF	CM-528
10	SCREW	AVZ2119	26	FM/AM TUNER MODULE	AXQ2314
11	BONNET CASE	4ZNT7345	27	CAUTION LABEL (C)	AVW1049
12	SCREW	BZ2307280PNC	28	SCREW	CS2309087ZK
13	SCREW	BZ2307280PNC	29	CAUTION LABEL (G)	AVW1046
14	SCREW	AVZ1941	30	CAUTION LABEL (H)	AVW1047
15	HEAT SINK	AVZ1984	31	CAUTION LABEL (I)	AVW1048
16	TRANSMITTER HOLDER	AVZ1984	32	CAUTION LABEL (J)	AVW1049
			33	CAUTION LABEL (K)	AVW1050
			34	CAUTION LABEL (L)	AVW1051
			35	CAUTION LABEL (M)	AVW1052

5

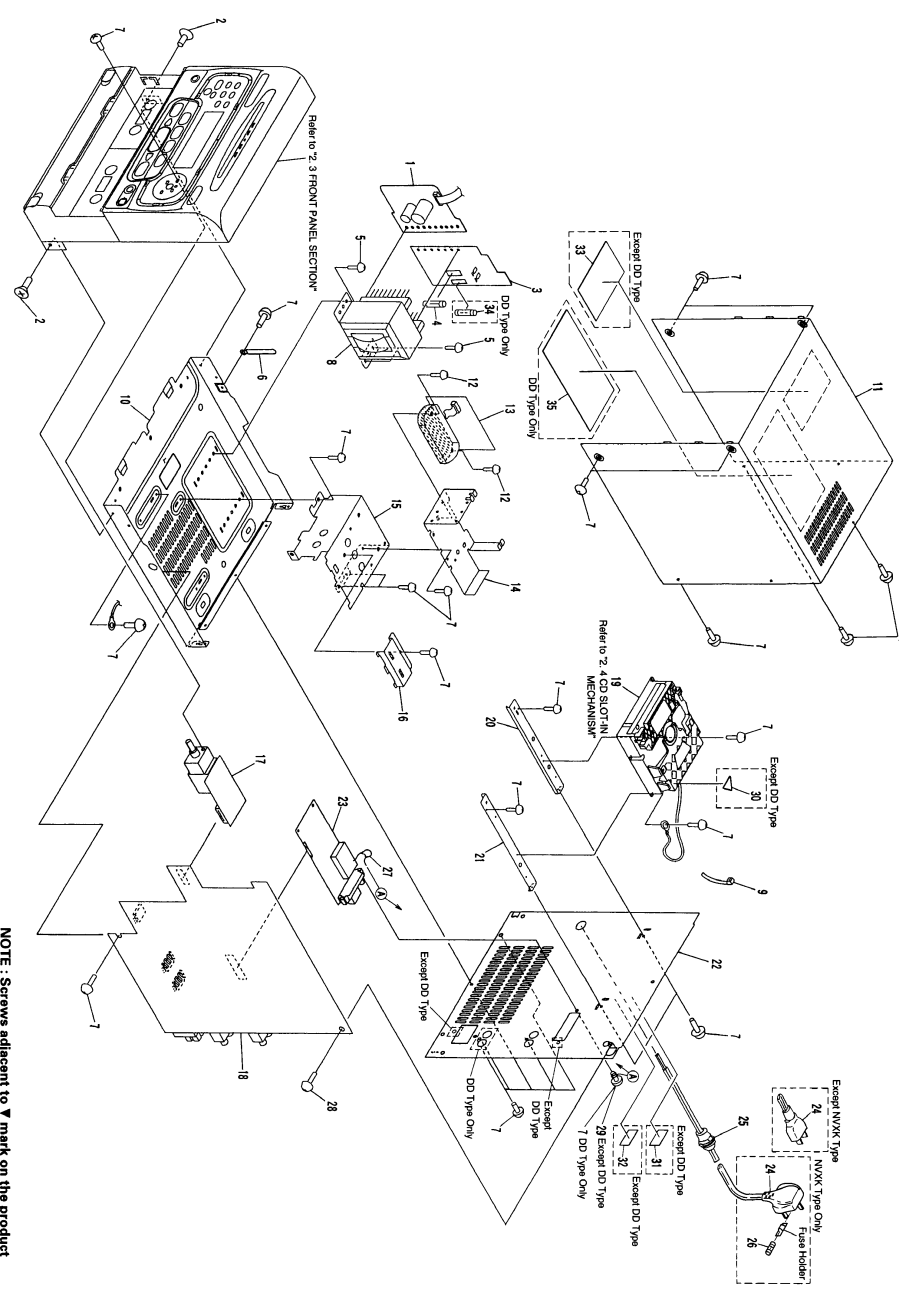

NOTE : Screws adjacent to ▼ mark on the product are used for disassembly.

XR-P160

2.3 FRONT PANEL SECTION

■ Contrast of XR-P160/NVXK, MVYK, MVYK/EA, MVYK/EB and DD
 XR-P160/NVXK, MVYK, MVYK/EA, MVYK/EB and DD have the same construction except for the following:

Mark No.	Description	Part No.				Remarks
		NVXK	MVYK	MVYK/EA	MVYK/EB	
NSP 1	H.P. ASSY	AW2830	AW2830	AW2830	AW2830	
2	FLAT	AW2817	AW2817	AW2817	AW2817	
3	ILLUMI ASSY	AZN7342	AZN7342	AZN7342	AZN7342	
4	FRONT PANEL	AZN7344	AZN7344	AZN7344	AZN7344	
10	Cassette door R	AW2814	AW2814	AW2814	AW2814	
13	DISP. ASSY	AW2814	AW2814	AW2814	AW2814	
15	Spring L	ABH7028	ABH7028	ABH7028	ABH7028	
17	Elect spring L	Not used	Not used	Not used	Not used	
18	Elect spring R	ABH7028	ABH7028	ABH7028	ABH7028	
19	Connector assy 9P (U)	ADX7046	ADX7046	ADX7046	ADX7046	
21	Connector assy 9P (U)	ADX7046	ADX7046	ADX7046	ADX7046	
22	Elect arm R	AMH7025	AMH7025	AMH7025	AMH7025	
23	Spring R	ABH7028	ABH7028	ABH7028	ABH7028	
24	Door spring R	Not used	Not used	Not used	Not used	
25	Door spring L	ABH7028	ABH7028	ABH7028	ABH7028	
26	Cassette door L	AW2814	AW2814	AW2814	AW2814	
NSP 27	Door spring R	AAK7289	AAK7289	AAK7289	AAK7279	
30	Door spring R	ABH7100	ABH7100	ABH7100	ABH7092	
43	Micro switch	Not used	Not used	Not used	Not used	

■ Parts List for XR-P160/NVXK

Mark No.	Description	Part No.	Mark No.	Description	Part No.
NSP 1	H.P. ASSY	AW2830	NSP 26	CASSETTE DOOR L	AZN7348
2	FLAT	AW2817	27	GEAR	AAK7229
3	ILLUMI ASSY	AZN7342	28	DECK WINDOW L	AAK7228
4	FRONT PANEL	AZN7344	29	DECK WINDOW R	AAK7224
5	SCREW	ABA1005	30	DOOR SPRING R	ABH7100
6	SCREW	BPZ301968P/K	31	SCREW	BRZ301968P/K
7	FL WINDOW	AAK7282	32	DIAMETER ASSY	AAK7021
8	EJECT ASSY	AW28116	33	EJECT BUTTON L	AAK7238
9	MOLD	AMH7029	34	VOL. KNOB	AAK7077
10	CASSETTE DOOR R	AZN7344	35	COLOR MOLD	AAK728
11	SCREW	BSZ20120P/K	36
12	PCB 28P (U)	ADD7020	37	P. BASS BUTTON	AAK7237
13	DISP. ASSY	AW2814	38	FUNCTION BUTTON	AAK7237
14	PCB 12P (U)	ADD7020	39	FUNCTION BUTTON	AAK7237
15	SPRING L	ABH7028	40	CD LENS	AAK725
16	COLLAR	BNH2135	41	EJECT BUTTON R	AAK7239
17	EJECT ARM L	AMH7025	42	NON STD SHEET	AAH1111
18	CONNECTOR ASSY 9P (U)	ADX7046			
19	CONNECTOR ASSY 9P (U)	ADX7046			
NSP 20	WIRE (U)	DR01570			
21	CONNECTOR ASSY 9P (U)	ADX7046			
22	EJECT ARM R	AMH7025			
23	SPRING R	ABH7028			
24	DOOR SPRING L	ABH7099			
25	SPRING	BBK1004			

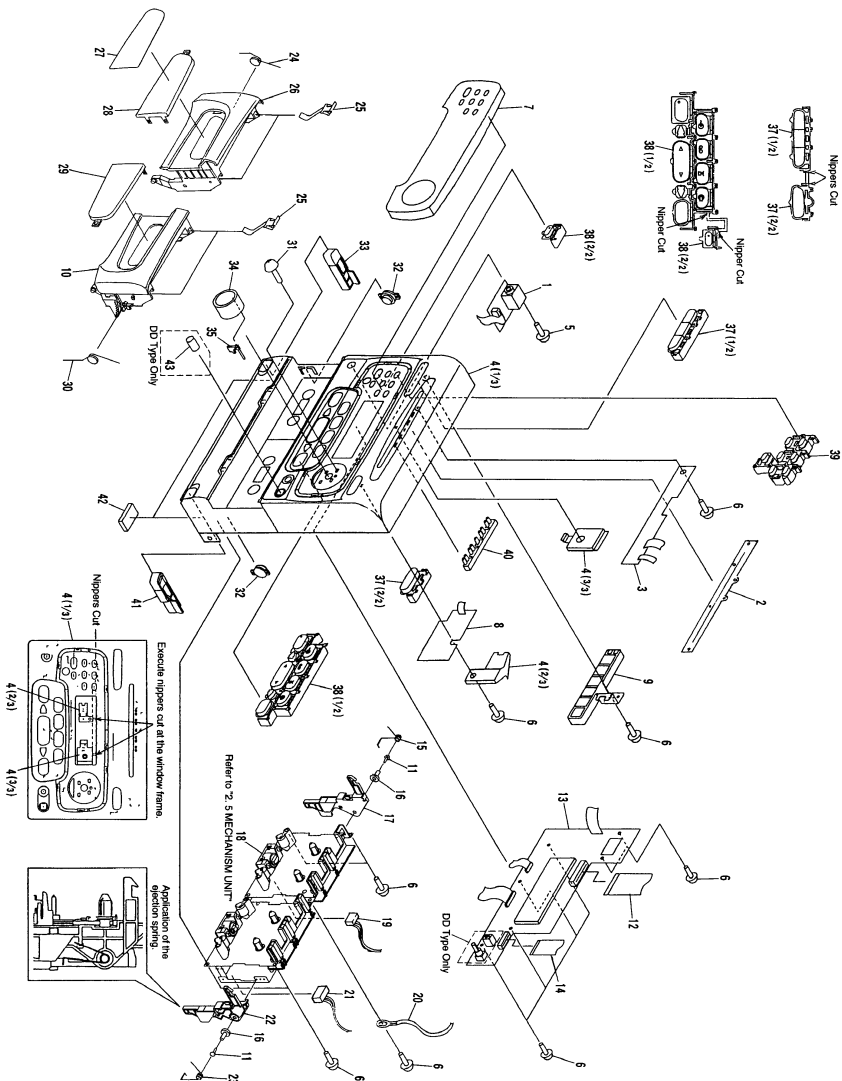

2.4 CD SLOT-IN MECHANISM

Mark No.	Description	Parts No.	Mark No.	Description	Parts No.	
NSP	1 SENSOR BOARD ASSY	AWZ7228	51	MOTOR ASSY	MR31000	
NSP	2 SW BOARD ASSY	AWZ7230	52	GROUND LEAD UNIT	FDJ1104	
NSP	3 SW BOARD ASSY	AWZ7331	53	GUIDE BAR	FLA1094	
NSP	4 MOTOR BOARD ASSY	AHBT035	54	GEAR STOPPER	PNM1303	
5	SPRING	AHBT019	NSP	55	GEAR STOPPER	PNW1608
6	ROCK LEVER SPRING	AHBT020	56	DISC TABLE	PNW2652	
7	CLAMP SPRING	AHBT021	57	GEAR 1	PNW2653	
8	BACK SPRING	AHBT022	58	GEAR 2	PNW2654	
9	SPRING	AHBT023	59	GEAR 3	PNW2655	
10	ROLLER HOLDER SPRING	AHBT024	60	FUNCTION GEAR	PNW2657	
11	SPRING B	AHBT025	61	FWB HOLDER	PNW2445	
12	CAM PLATE SPRING	AHBT026	62	CARBIDG BASE	PRM1027	
13	BEZEL	AHBT027	63	DC MOTOR (CARBIDG)	BR226706DFNC	
14	BEZEL	AHBT028	64	SCREW	BR226706DFNC	
15	PHI	ALA1005	65	SCREW	BR226706DFNC	
16	MECHANISM BASE	ANW7022	66	SCREW	BR226706DFNC	
17	DIRECT PLATE	ANW7023	67	SCREW	IFZ1170297FK	
18	CLAMPER HOLDER	ANW7025	68	DC MOTOR ASSY (SPINDLE)	FEA1256	
19	ROLLER HOLDER	ANW7078	70	DC MOTOR ASSY (CARBIDG)	FEA1246	
20	ROLLER HOLDER	ANW7029	71	ROCKER ASSY	PEA1261	
21	GEAR HOLDER	ANW7028	72	AT-SHEET	AHBT021	
22	BACK LEVER	ANW7030	73	DISC PLATE SHEET	AHBT035	
23	STARTING LEVER	ANW7031	OTHERS			
24	CAM PLATE	ANW7032		OIL (GREEN)	GEN1015	
25	GEAR PULLEY	ANW7033				
26	GEAR A	ANW7034				
27	GEAR B	ANW7035				
28	GEAR C	ANW7036				
29	GEAR D	ANW7037				
30	GEAR E	ANW7038				
31	DRIVE GEAR	ANW7039				
32	STARTING PLATE	ANW7040				
33	CLAMPER ASSY L	ANW7041				
34	ROLLER ASSY R	ANW7042				
35	ROLLER ASSY L	ANW7043				
36	SCREW	PEA1048				
NSP	H-STOP GEAR	PEA1049				
NSP	Y-STOP GEAR	PEA1050				
38	YOKE	PNB1316				
39	YOKE	PNW1634				
40	MOTOR RULLEY	PRM1029				
NSP	MOTOR	AXM1017				
43	CONNECTOR ASSY 2P	PEE1238				
44	(2mm FITCH) FLOOR RUBBER	PEB1014				
44	FLOOR RUBBER	PEB1132				
45	SCREW	BRZ20P06DFNC				
46	SCREW	PPZ20P06DFNC				
47	WASHER	WT120820DFNC				
48	WASHER	WT120820DFNC				
49	WASHER	WT120820DFNC				
50	WASHER	WT120820DFNC				

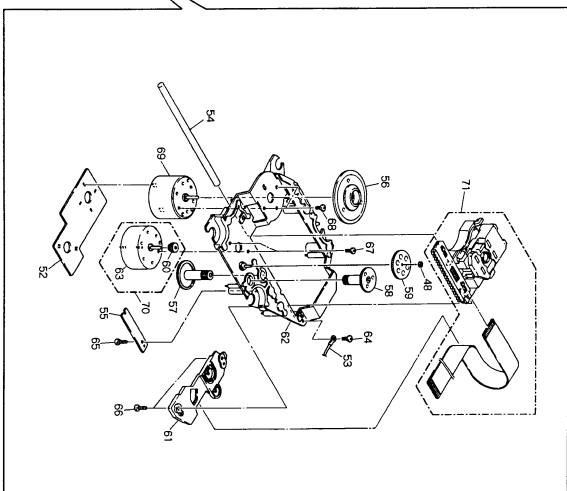
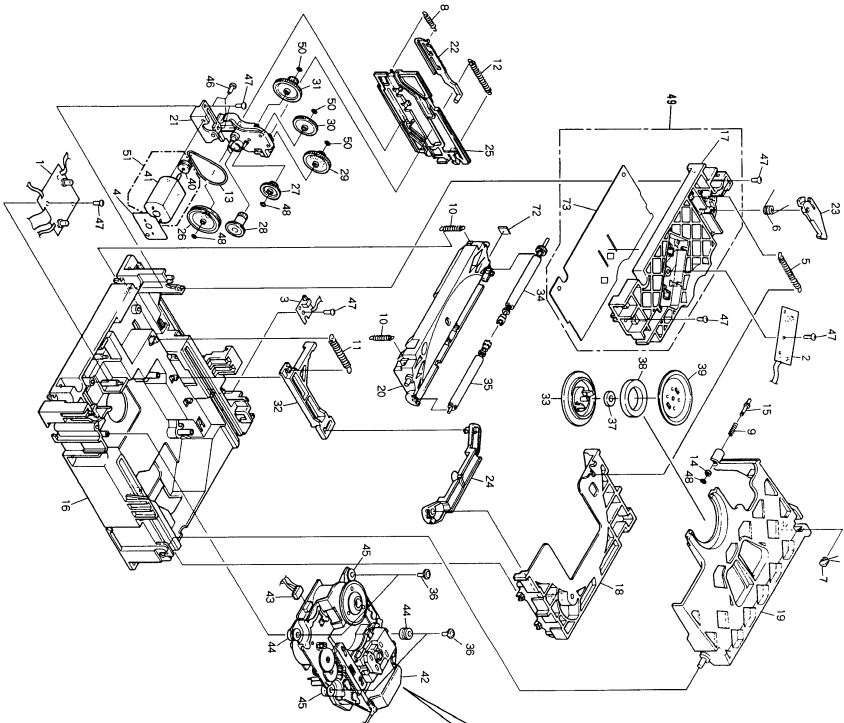

● How to install the disc table

- 1 Use nipper or other tool to cut the three sections marked (A) in figure 1. Then remove the spacer.
- 2 While supporting the spindle motor shaft with the stopper, put spacer on top of the motor base (angled so it doesn't touch section (B)), and rock the disc table on top (takes about 3kg pressure). Take off the spacer.

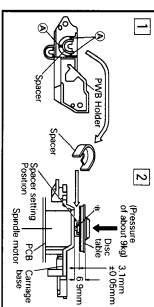

2.5 MECHANISM UNIT

■ Mechanism unit I and II (1/2)

Mark No.	Description	Parts No.
1	ASSY MOTOR	RKA1060
2	BRACKET MOTOR	RNI1436
3	BRACKET MOTOR	RNI1436
4	SPACER	RNK1822
5	SCREW	RBA1100
6	SCREW	PC2209P0407MC

■ Mechanism unit I and II (2/2)

Mark No.	Description	Parts No.
1	ASSY HOLDER HEAD (*1)	RKA1400
2	ASSY HOLDER HEAD (*2)	RKA1404
3	LEVER HEAD	RKA1404
4	SPRING AZIMUTH	RNK1006
5	ASSY ARM ASSIST	RNK1117
6	GEAR ARM HEAD	RNK1039
7	SPRING CASSETTE	RNK1118
8	EJECT LOCK	RNK1119
9	CAP REEL	RKA1403
10	ASSY PINCH ARM L	RNE1437
11	CHASSIS HEAD	RKA1404
12	ASSY PINCH ARM R	RKA1404
13	ARM PLATE L	RNK1866
14	ARM PLATE R	RNK1866
15	CHASSIS OS	RKA1411
16	ASSY SLD REBEL L	RKA1411
17	ASSY SLD REBEL R	RKA1411
18	WIRE	RNC1006
19	ARM NYS	RNK1721
20	ARM NYS	RNK1721
21	GEAR PR	RNK1722
22	ASSY ARM PR	RKA1412
23	ASSY PULLEY PR	RKA1413

Mark No.	Description	Parts No.
41	BRACKET PR (*1)	RNI1434
42	BRACKET PR (*2)	RNI1436
43	PULLEY (*1 only)	RNK1232
44	BELT FW (*1 only)	RBN1291
45	BELT MAIN (*2)	RBN1289
46	F. C. BOARD	RNT1348
47	HOUSING (*1)	RKT1396
48	CONNECTOR (*1)	RKP1713
49	CONNECTOR (*2)	RKP1714
50	ASSY HOLDER (*1 only)	RKA1689
51	SPRING	RBH1282
52	SPRING	RBH1283
53	SPRING	RBH1284
54	SPRING	RBH1285
55	SPRING	RBH1286
56	SPRING	RBH1291
57	SPRING	RBH1285
58	SPRING	RBH1289
59	SPRING	RBH1290
60	SPRING	RBH1292
61	SPRING (SPRING)	RBH1292
62	SPRING	RBH1292
63	SCREW (F.C. AZIMUTH)	RBA1023
64	SCREW	RBA1027
65	SCREW	RBA1027
66	SCREW	RBA1030
67	SCREW	RBA1034
68	SCREW	RBA1034
69	SCREW	RBA1034
70	WASHER	RBT1046

● Mechanism Unit I and II(1/2)

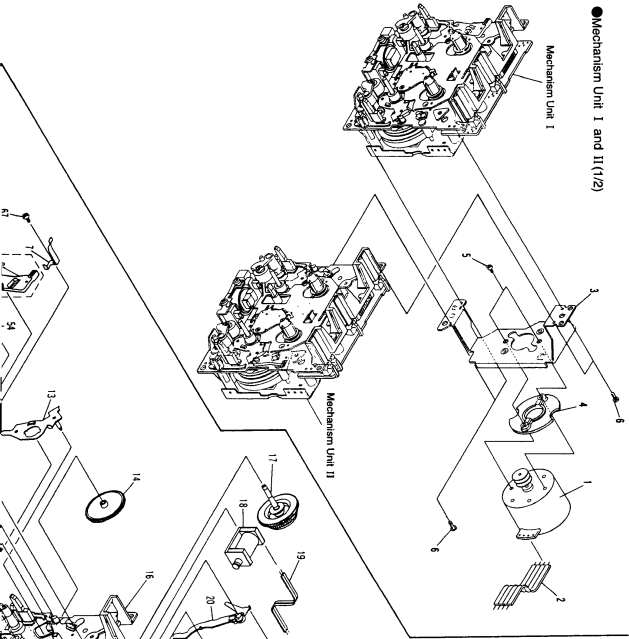

● Mechanism Unit I and II(2/2)

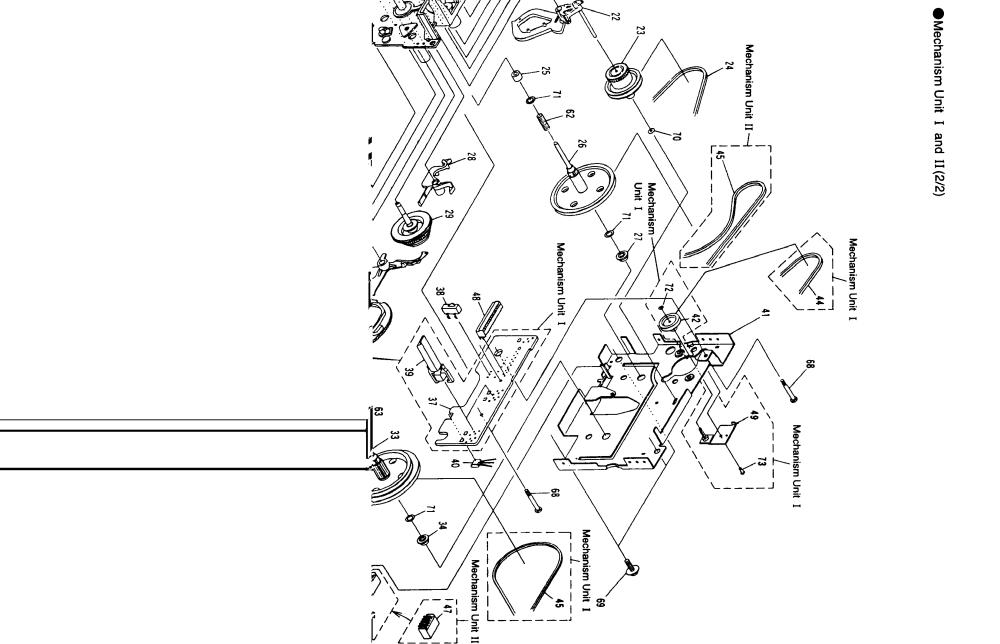

- This diagram is viewed from the mounted parts side.

NOTE FOR PCB DIAGRAMS:

1. Part numbers in PCB diagrams match those in the schematic diagrams.
2. A comparison between the main parts of PCB and schematic diagrams is shown below.

Symbol in PCB Diagrams	Symbol in Schematic Diagrams	Part Name
		Transistor
		Diode
		Capacitor (Polarized)

3. The transistor terminal marked with E or □ shows the emitter.
4. The diode terminal marked with ⊕ or ⊖ shows cathode side.
5. The capacitor terminal marked with ⊕ or ⊖ shows negative terminal.

NOTE FOR PCB DIAGRAMS:

1. Part numbers in PCB diagrams match those in the schematic diagrams.
2. A comparison between the main parts of PCB and schematic diagrams is shown below.

Symbol in PCB Diagrams	Symbol in Schematic Diagrams	Part Name
		Transistor
		Transistor with resistor
		Field effect transistor
		Resistor array
		3-terminal regulator

FM/AM TUNER MODULE

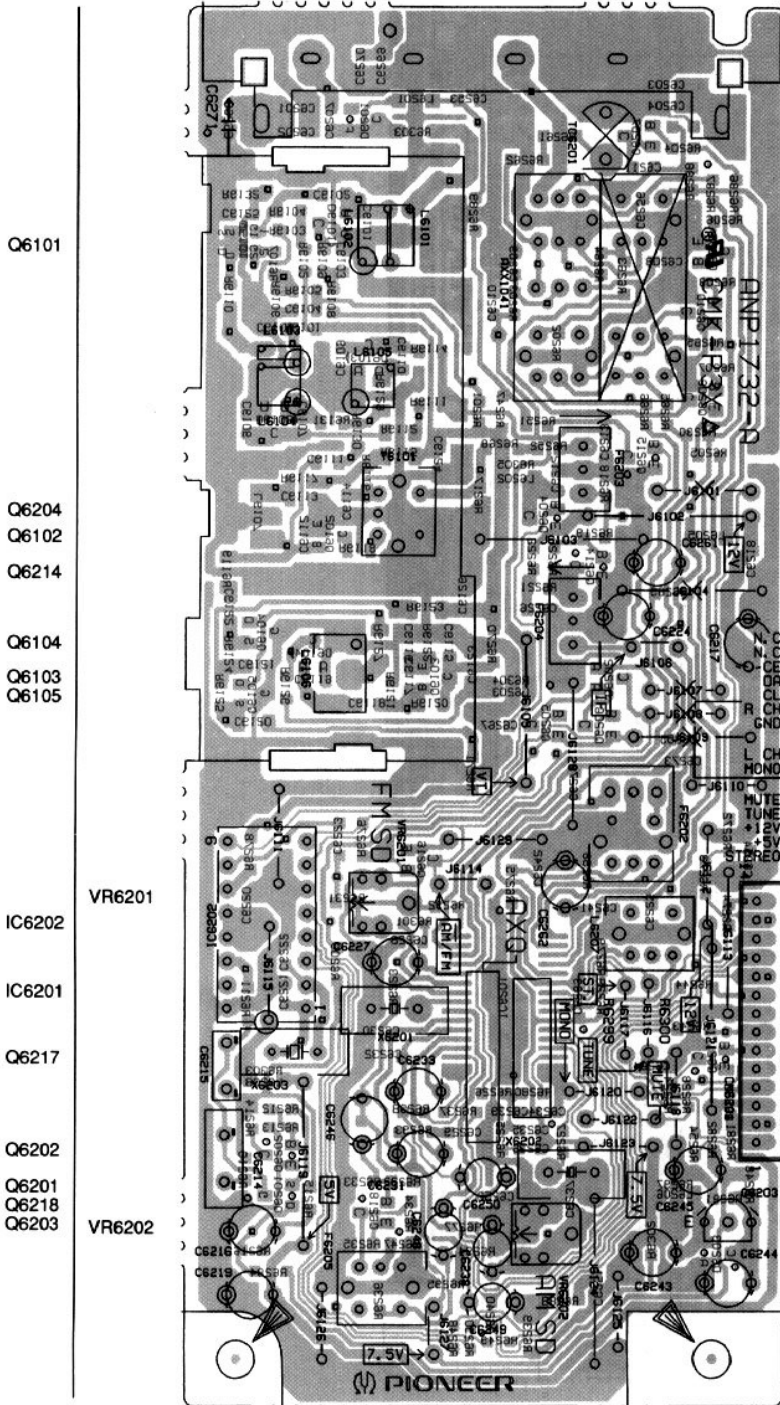

The parts mounted on this PCB include all necessary parts for several destinations. For further information for respective destinations, be sure to check with the schematic diagram.

XR-P160

● For DD type (AXQ3112)

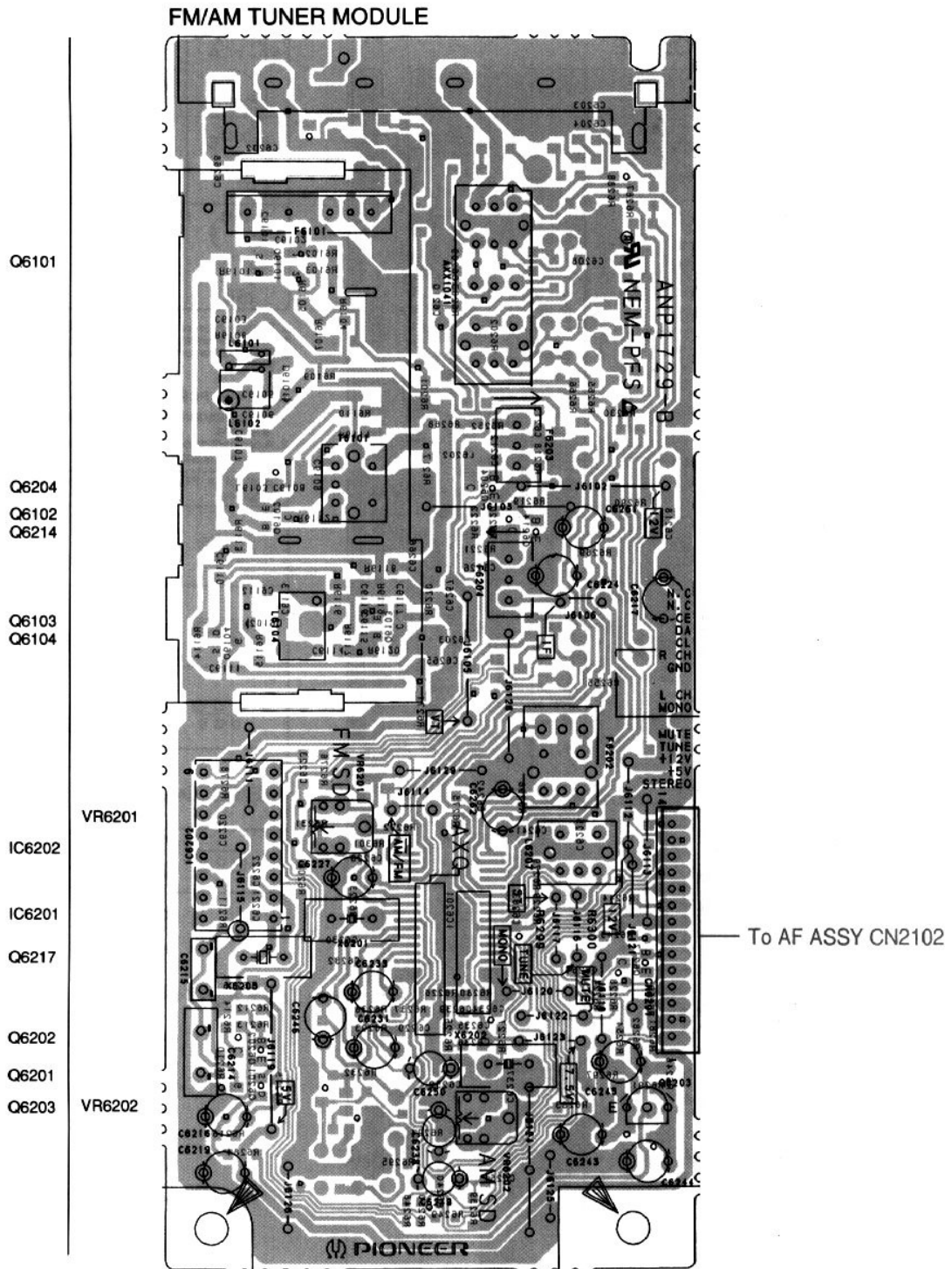

● This diagram is viewed from the mounted parts side.

3.3 LED BOARD ASSY, SW BOARD ASSY, SENSOR BOARD ASSY, MOTOR BOARD ASSY, MECHANISM BOARD ASSY AND PICKUP ASSY

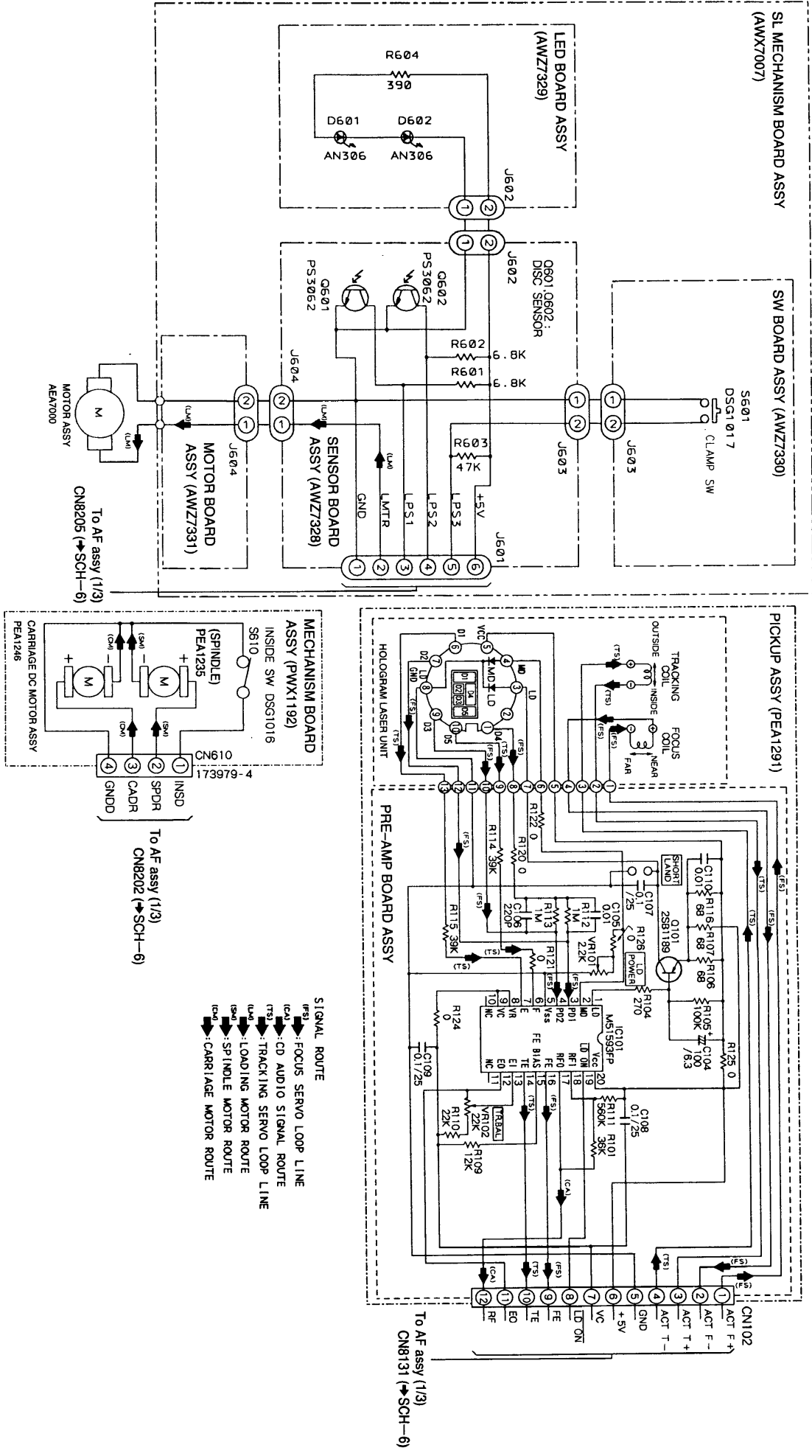

SCH-4

SCH-4

LED BOARD ASSY, SW BOARD ASSY,
SENSOR BOARD ASSY, MOTOR BOARD ASSY,
MECHANISM BOARD ASSY, PICKUP ASSY

SCH-4

LED BOARD ASSY, SW BOARD ASSY,
SENSOR BOARD ASSY, MOTOR BOARD ASSY,
MECHANISM BOARD ASSY, PICKUP ASSY

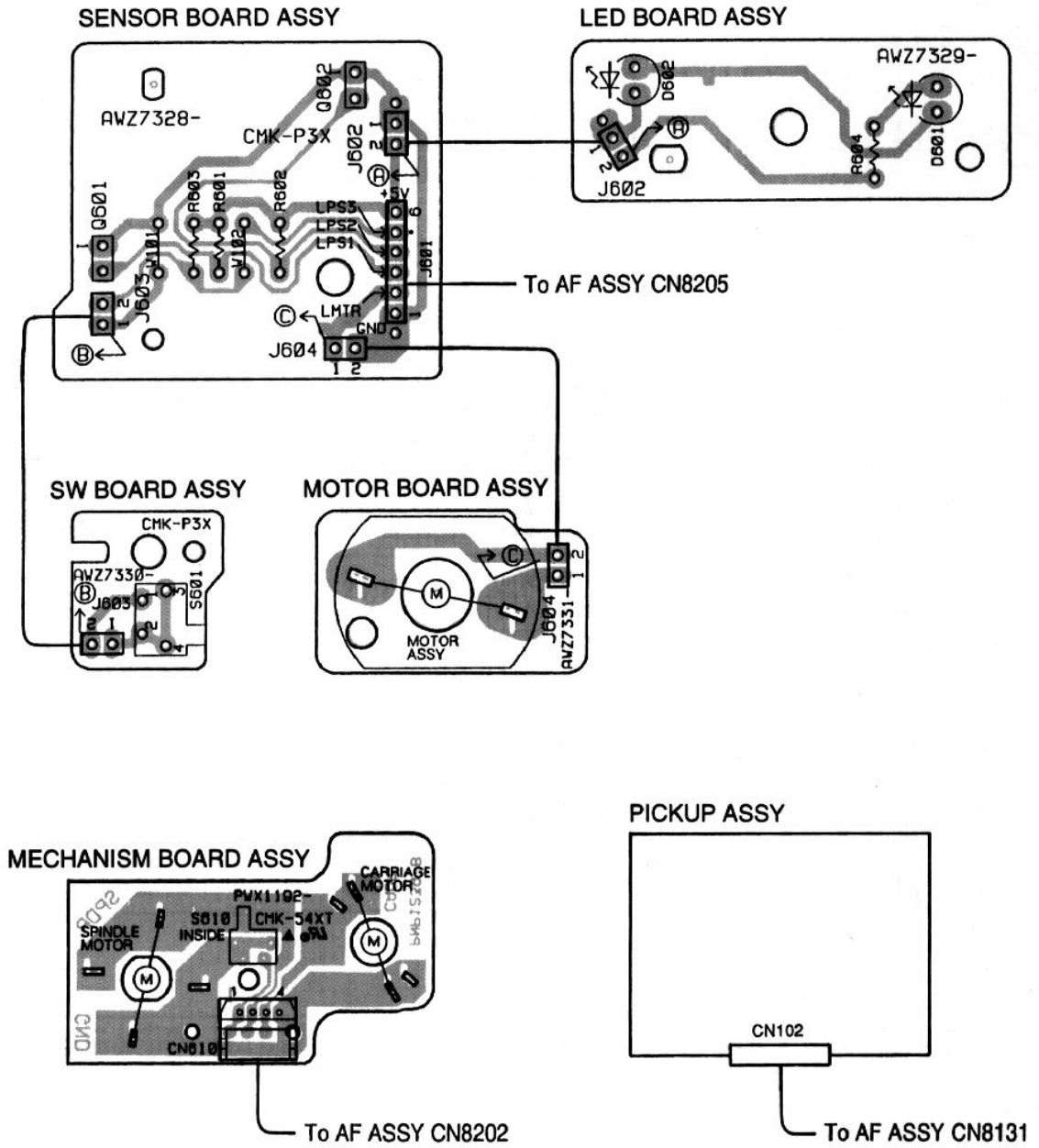

• This diagram is viewed from the mounted parts side.

Waveforms

Note: The encircled numbers denote measuring point in the schematic diagram.

*2 FOCUS: Press the key without loading a disc.

<p>② TP1-Pin1: PLAY MODE (RFI) 500mV/div 500nsec/div</p> <p>- GND</p>	<p>⑤ IC8202-Pin3: FOCUS-IN (*2) MODE (FODRI) 1V/div 200msec/div</p> <p>- GND</p>	<p>⑦ IC8201-Pin3: PLAY MODE (SPDR) 1V/div 50msec/div</p> <p>- GND</p>
<p>② TP1-Pin1: TRACK SEARCH MODE (RFI) 500mV/div 200nsec/div</p> <p>- GND</p>	<p>⑤ IC8202-Pin3: PLAY MODE (FODRI) 1V/div 1msec/div</p> <p>- GND</p>	<p>⑦ IC8201-Pin3: TRACK SEARCH MODE (SPDR) 2V/div 50msec/div</p> <p>- GND</p>
<p>③ TP1-Pin6: PLAY MODE (FOERI) 100mV/div 10msec/div</p> <p>- GND</p>	<p>⑧ IC8202-Pin4: PLAY MODE (TRDR) 800mV/div 1msec/div</p> <p>- GND</p>	<p>⑧ IC8202-Pin9: PLAY MODE (CADRI) 0.2V/div 2nsec/div</p> <p>- GND</p>
<p>④ TP1-Pin2: PLAY MODE (TRER) 1V/div 1msec/div</p> <p>- GND</p>	<p>⑧ IC8202-Pin9: TRACK SEARCH MODE (CADRI) 2V/div 200msec/div</p> <p>- GND</p>	

<p>⑨ IC8151-Pin32: PLAY MODE (EFM) 2V/div 500nsec/div</p> <p>- GND</p>	<p>⑲ IC8301-Pin4: PLAY MODE (1KHz) (PCND) 2V/div 500nsec/div</p> <p>- GND</p>	<p>⑳ IC8301-Pin26: PLAY MODE (MDPI) 2V/div 2nsec/div</p> <p>- GND</p>
<p>⑯ IC8301-Pin48: PLAY MODE (1KHz) (LRCK) 2V/div 500nsec/div</p> <p>- GND</p>	<p>㉑ : TRACK SEARCH MODE Upper: TP1-Pin1 (RFI) 1V/div Lower: IC8151-Pin26 (C. OUT) 2V/div 50nsec/div</p> <p>- GND</p>	<p>㉒ : PLAY MODE Upper: TP1-Pin1 (RFI) 1V/div Lower: IC8151-Pin30 (DF-CT1) 5V/div 200nsec/div</p> <p>- GND</p>
<p>⑰ IC8301-Pin42: PLAY MODE (1KHz) 2V/div 10nsec/div</p> <p>- GND</p>	<p>⑳ IC8301-Pin4: PLAY MODE (1KHz) 2V/div 500nsec/div</p> <p>- GND</p>	<p>㉒ : PLAY MODE Upper: TP1-Pin1 (RFI) 1V/div Lower: IC8151-Pin30 (DF-CT1) 5V/div 200nsec/div</p> <p>- GND</p>

IC8151 (CX11372Q)

Pin No.	Voltage V/div	Pin No.	Voltage V/div	Pin No.	Voltage V/div	Pin No.	Voltage V/div
1	2.5	13	2.5	25	5.0	37	2.0
2	2.5	14	2.5 to 2.6	26	0.1	38	2.7 to 2.8
3	2.5	15	2.5	27	4.9	39	2.5
4	2.5	16	0.8	28	0	40	3.2
5	2.4	17	1.3	29	0	41	0
6	2.5	18	2.5	30	0	42	2.5
7	2.6	19	0	31	0	43	2.5
8	2.5	20	5.0	32	2.7	44	2.5
9	2.5	21	5.0	33	5.0	45	2.5
10	5.0	22	4.9	34	1.3	46	2.5
11	2.5	23	5.0	35	1.0	47	2.5
12	2.5	24	4.9 to 5.0	36	5.0	48	2.4

IC8301 (CXD2508AQ)

Pin No.	Voltage V/div	Pin No.	Voltage V/div	Pin No.	Voltage V/div	Pin No.	Voltage V/div
1	0.1	21	5.0	41	2.4	61	0
2	0.1	22	0	42	2.4	62	0
3	5.0	23	5.0	43	2.4	63	0
4	0.1	24	5.0	44	2.4	64	2.5
5	4.9	25	2.8 to 2.7	45	2.4	65	0
6	0	26	0.1	46	1.8	66	0
7	2.2 to 2.5	27	5.0	47	1.8	67	0
8	5.0	28	0	48	0	68	5.0
9	4.9	29	2.7	49	4.9	69	2.5
10	5.0	30	2.6	50	1.2	70	2.5
11	4.9	31	2.6	51	4.9	71	5.0
12	0	32	5.0	52	2.5	72	5.0
13	4.9	33	0	53	0	73	2.4
14	0.1	34	2.7	54	0	74	2.4
15	4.9 to 5.0	35	5.0	55	4.9	75	0
16	5.0	36	2.7	56	4.5	76	0
17	4.9	37	0	57	0	77	2.5
18	0	38	0	58	0 to 0.3	78	2.5
19	0	39	2.5	59	2.8	79	0
20	0	40	0	60	1.4	80	0

To FM/AM TUNER MODULE
CN6201 (SCH-2 and 3)

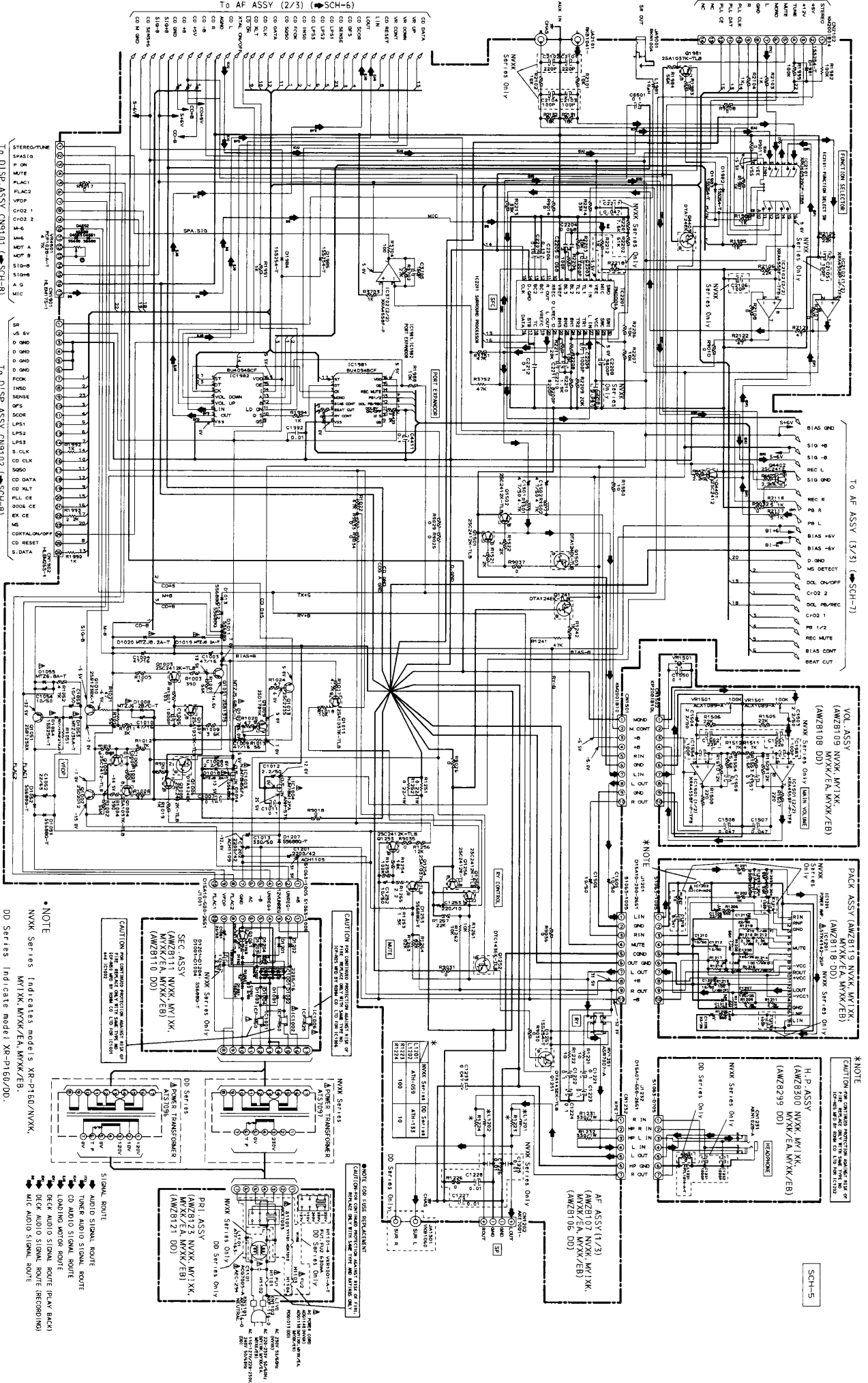

SCH-5

AF ASSY(1/3), VOL ASSY, SEC ASSY,
PACK ASSY, PRI ASSY, H.P. ASSY,
MECHANISM UNIT(1/2)

AF ASSY(1/3), VOL ASSY, SEC ASSY,
PACK ASSY, PRI ASSY, H.P. ASSY,
MECHANISM UNIT(1/2)

SCH-5

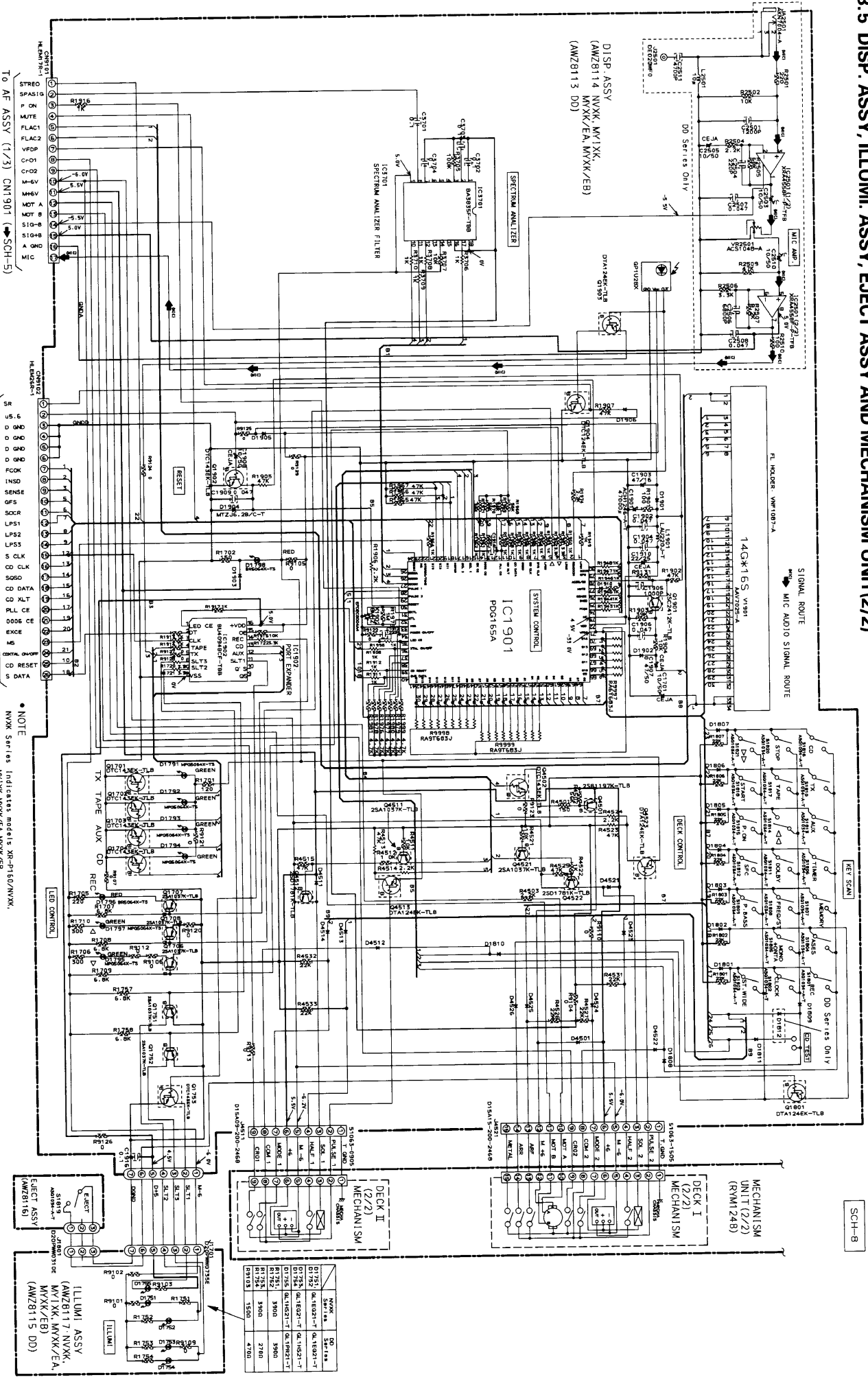

TO AF ASSY (1/3) CN1901 (SCH-5)

TO AF ASSY (1/3) CN1902 (SCH-5)

NOTE
NXXK Series Indicates model's XR-P160/NXXK,
MXXK, MXXK/EA, MXXK/EB,
DD Series Indicate model's XR-P160/DD.

DISP. ASSY, ILLUMI. ASSY,
EJECT ASSY, MECHANISM UNIT(2/2)

SCH-8

DISP. ASSY, ILLUMI. ASSY,
EJECT ASSY, MECHANISM UNIT(2/2)

DISP. ASSY, ILLUMI. ASSY,
EJECT ASSY, MECHANISM UNIT(2/2)

SCH-8

NXXK	DD
D1751	DL1624-T
D1752	DL1624-T
D1753	DL1624-T
D1754	DL1624-T
D1755	DL1624-T
D1756	DL1624-T
D1757	DL1624-T
D1758	DL1624-T
D1759	DL1624-T
D1760	DL1624-T
D1761	DL1624-T
D1762	DL1624-T
D1763	DL1624-T
D1764	DL1624-T
D1765	DL1624-T
D1766	DL1624-T
D1767	DL1624-T
D1768	DL1624-T
D1769	DL1624-T
D1770	DL1624-T
D1771	DL1624-T
D1772	DL1624-T
D1773	DL1624-T
D1774	DL1624-T
D1775	DL1624-T
D1776	DL1624-T
D1777	DL1624-T
D1778	DL1624-T
D1779	DL1624-T
D1780	DL1624-T
D1781	DL1624-T
D1782	DL1624-T
D1783	DL1624-T
D1784	DL1624-T
D1785	DL1624-T
D1786	DL1624-T
D1787	DL1624-T
D1788	DL1624-T
D1789	DL1624-T
D1790	DL1624-T
D1791	DL1624-T
D1792	DL1624-T
D1793	DL1624-T
D1794	DL1624-T
D1795	DL1624-T
D1796	DL1624-T
D1797	DL1624-T
D1798	DL1624-T
D1799	DL1624-T
D1800	DL1624-T
D1801	DL1624-T
D1802	DL1624-T
D1803	DL1624-T
D1804	DL1624-T
D1805	DL1624-T
D1806	DL1624-T
D1807	DL1624-T
D1808	DL1624-T
D1809	DL1624-T
D1810	DL1624-T
D1811	DL1624-T
D1812	DL1624-T
D1813	DL1624-T
D1814	DL1624-T
D1815	DL1624-T
D1816	DL1624-T
D1817	DL1624-T
D1818	DL1624-T
D1819	DL1624-T
D1820	DL1624-T
D1821	DL1624-T
D1822	DL1624-T
D1823	DL1624-T
D1824	DL1624-T
D1825	DL1624-T
D1826	DL1624-T
D1827	DL1624-T
D1828	DL1624-T
D1829	DL1624-T
D1830	DL1624-T
D1831	DL1624-T
D1832	DL1624-T
D1833	DL1624-T
D1834	DL1624-T
D1835	DL1624-T
D1836	DL1624-T
D1837	DL1624-T
D1838	DL1624-T
D1839	DL1624-T
D1840	DL1624-T
D1841	DL1624-T
D1842	DL1624-T
D1843	DL1624-T
D1844	DL1624-T
D1845	DL1624-T
D1846	DL1624-T
D1847	DL1624-T
D1848	DL1624-T
D1849	DL1624-T
D1850	DL1624-T
D1851	DL1624-T
D1852	DL1624-T
D1853	DL1624-T
D1854	DL1624-T
D1855	DL1624-T
D1856	DL1624-T
D1857	DL1624-T
D1858	DL1624-T
D1859	DL1624-T
D1860	DL1624-T
D1861	DL1624-T
D1862	DL1624-T
D1863	DL1624-T
D1864	DL1624-T
D1865	DL1624-T
D1866	DL1624-T
D1867	DL1624-T
D1868	DL1624-T
D1869	DL1624-T
D1870	DL1624-T
D1871	DL1624-T
D1872	DL1624-T
D1873	DL1624-T
D1874	DL1624-T
D1875	DL1624-T
D1876	DL1624-T
D1877	DL1624-T
D1878	DL1624-T
D1879	DL1624-T
D1880	DL1624-T
D1881	DL1624-T
D1882	DL1624-T
D1883	DL1624-T
D1884	DL1624-T
D1885	DL1624-T
D1886	DL1624-T
D1887	DL1624-T
D1888	DL1624-T
D1889	DL1624-T
D1890	DL1624-T
D1891	DL1624-T
D1892	DL1624-T
D1893	DL1624-T
D1894	DL1624-T
D1895	DL1624-T
D1896	DL1624-T
D1897	DL1624-T
D1898	DL1624-T
D1899	DL1624-T
D1900	DL1624-T

The parts mounted on this PCB include all necessary parts for several destinations.
For further information for respective destinations, be sure to check with the schematic diagram.

- This diagram is viewed from the mounted parts side.

DISP. ASSY

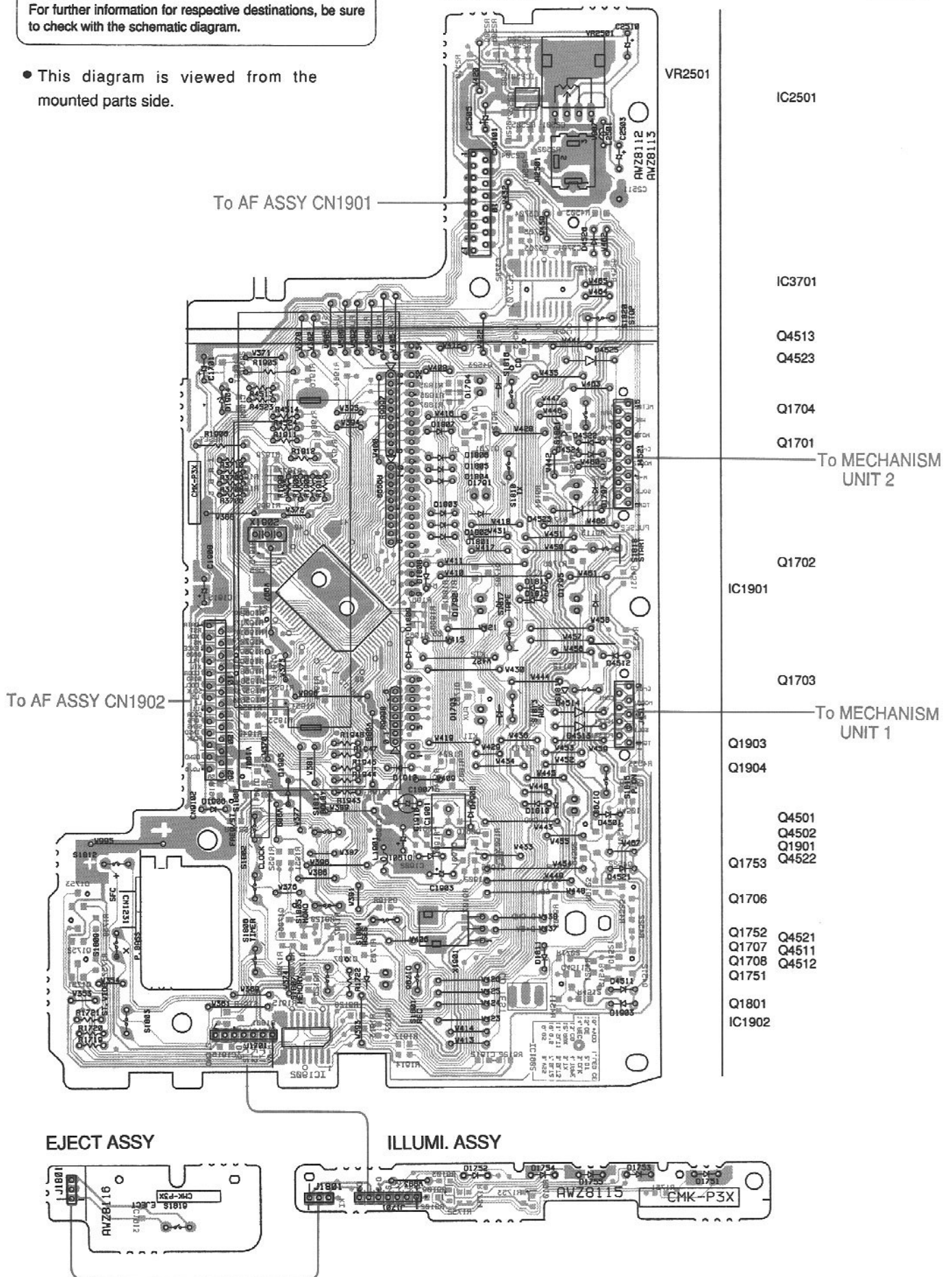

Mark No.	Description	Parts No.	Mark No.	Description	Parts No.
SWITCHES AND RELAYS			C4311, C4312		CKSQYB823K25
RY1251		ASR7007	C8207, C8210, C8215, C8219		CKSQYF103Z50
CAPACITORS			C2206, C2207, C4411, C8158, C8159		CKSQYF104Z25
C1201, C1202		ACH1109	C8161, C8163, C8220, C8420, C8421		CKSQYF104Z25
C4362		CCCSL151K500	C1225, C1226, C4409, C4410		CQMA103J50
C4319, C4320		CCCSL271K500	C4358		CQMA223J50
C4113, C4114, C4323, C4324, C8322		CCSQCH100D50	C2204, C2205		CQMA683J50
C2103-C2106, C4391, C4392		CCSQCH101J50	C4361		CQPA822J100
C8311-C8313		CCSQCH101J50	RESISTORS		
C8407-C8410		CCSQCH121J50	R4360		RD1/2PM151J
C3705		CCSQCH151J50	R4353		RD1/2PM181J
C4601, C8323		CCSQCH220J50	R4357		RD1/2PM4R7J
C2101, C2102		CCSQCH221J50	R1051		RD1/4PMF272J
C8403-C8406		CCSQCH271J50	R1223, R1224		RD1/4PMFL101J
C4109, C4110, C8401, C8402		CCSQCH391J50	R1221, R1222		RD1/6PM100J
C4191, C4192		CCSQCH470J50	R1990, R1992, R8651		RD1/6PM102J
C4101, C4102, C4515, C4516		CCSQCH471J50	R1261, R1262, R4409, R4410, R4451		RD1/6PM103J
C4151, C4152		CCSQCH681J50	R1982		RD1/6PM104J
C8411, C8412		CEANP2R2M50	R4459		RD1/6PM105J
C4303, C4304, C4451, C4452, C8314		CEAS010M50	R1253		RD1/6PM152J
C1053, C1054, C1252, C1505, C1506		CEAS100M50	R1993, R4691		RD1/6PM222J
C4364, C4403-C4405, C4407, C4454		CEAS100M50	R1021, R3704		RD1/6PM470J
C4401, C4408		CEAS101M10	R1241, R3752		RD1/6PM473J
C1052, C4453		CEAS220M63	R2118		RD1/6PM512J
C1253		CEAS221M10	R1013, R1014		RD1/6PM560J
C1008, C1012		CEAS2R2M50	R1263, R1264		RD1/6PM823J
C4103, C4104, C4309, C4310, C8301		CEAS330M16	R1231, R1232		RS1LMF331J
C8175, C8176, C8315		CEAS331M16	R1251, R1252		RS1PMFR22J
C1013		CEAS331M50	VR4301, VR4302, VR4501 (4.7kΩ)		PCP1028
C4357		CEAS3R3M50	VR4201-VR4204 (10kΩ)		PCP1029
C1003, C1009, C1010, C4107, C4108		CEAS470M16	VR8151, VR8152 (22kΩ)		PCP1030
C4351, C4359, C4360		CEAS470M16	VR4351, VR4352 (220kΩ)		PCP1033
C1501, C1502, C4207, C4208		CEAS4R7M50	Other Resistors		RS1/10S□□□J
C4301, C4302, C4315, C4316, C8160		CEAS4R7M50	OTHERS		
C8162		CEAS4R7M50	CN8131	12P FPC CONNECTOR	12FMZ-ABT
C4402, C4406		CEASR68M50	CN8202	4P MT CONNECTOR	173981-4
C1004		CEJA470M16		10P CABLE HOLDER	51063-1005
C8309		CEJAR47M50	CN8205	4P SPEAKER TERMINAL	52147-0610
C4604		CFTXA823J50			AKE7001
C2217, C2218, C4251-C4253		CKCYF473Z50	X8301	SMALL HEAT SINK	ANH-575
C2212		CKCYX104M16		XTAL RES	ASS7000
C1005, C1006, C2203, C2209, C8171		CKSQYB102K50	CN4003	(OSC)33.8688MHz-700PPM)	
C8321		CKSQYB102K50	CN4002	2P TOP POST (EH)	B2B-EH
C1227, C1228, C1992, C8157, C8164		CKSQYB103K50	CN4002	3P TOP POST (EH)	B3B-EH
C8167, C8169, C8218, C8308, C8361		CKSQYB103K50	CN4001	3P TOP POST (EH, RED)	B3B-EH-R
C1007, C1011, C1221-C1224		CKSQYB104K25	CN1901	FFC CONNECTOR 17P	HLEM17S-1
C8302, C8303, C8362		CKSQYB104K25	CN1902	26P FFC CONNECTOR	HLEM26S-1
C8306		CKSQYB152K50	CN1501	10P PLUG	KM200IB10
C4313, C4314		CKSQYB182K50	CN2102	14P PLUG	KM200IB14
C4307, C4308		CKSQYB273K50	CN1232	7P JUMPER CONNECTOR	KPE7
C4352, C4354, C8170		CKSQYB332K50	JA2101	AUDIO 2P JACK	RKB1041
C4305, C4306, C8156, C8168		CKSQYB333K50	JA9001	REMOTE CONTROL JACK	RKN1004
C4356, C8172		CKSQYB472K50		PCB BINDER	VEF1008
C1233, C4111, C8307		CKSQYB473K25	CN8201	6P SIDE POST	VKN-004
C8155		CKSQYB561K50			
C2208		CKSQYB562K50			
C4105, C4106		CKSQYB682K50			
C2210, C2211		CKSQYB822K50			

XR-P160

Mark No.	Description	Parts No.
VOL. ASSY		
SEMICONDUCTORS		
IC1501		XRA4558F-P
CAPACITORS		
C1553, C1554		CCSQCH101J50
C1551, C1552		CCSQCH220J50
C1503, C1504		CEAS2R2M50
C1557, C1558		CKSQYB104K25
C1550		CKSQYF104Z25
C1507, C1508		CKSQYF473Z50
RESISTORS		
VR1501		ACX1089
Other Resistors		RS1/10S□□□J
OTHERS		
CN1502		KP200IB10L
SEC. ASSY		
SEMICONDUCTORS		
IC1006		ICP-N25
IC1001, IC1002		ICP-N50
Q1061		2SC2412K
D1016, D1017, D1061, D1062		1SS254
D1001-D1004, D1201-D1204		S5688G
CAPACITORS		
C1002		CEAS102M16
C1051		CEAS220M63
C1001		CEAS222M16
C1061		CEAS2R2M50
C1014		CQPA103J100
RESISTORS		
Other Resistors		RS1/10S□□□J
OTHERS		
	10P CABLE HOLDER	51063-1005
DISP. ASSY		
SEMICONDUCTORS		
IC3701		BA3835F
IC1902		BU4094BCF
IC1901		PDG165A
Q1706-Q1708, Q1751, Q1752, Q4511		2SA1037K
Q4521		2SA1037K
Q4501		2SB1197K
Q1901		2SC2412K
Q4512, Q4522		2SD1781K
Q1801, Q1903, Q4513, Q4523		DTA124EK
Q1904		DTC124EK
Q1701-Q1704, Q1753, Q1902, Q4502		DTC143EK
D1801-D1811, D1901-D1903		1SS254
D1905, D1906, D1910, D4501		1SS254
D4511-D4514, D4521-D4526		1SS254
D1796, D1798		BR5064X
D1791-D1795, D1797		MPG5064X
D1904		MTZJ6.2B
COILS AND FILTERS		
L1901		LAU220J

Mark No.	Description	Parts No.
SWITCHES AND RELAYS		
	S1801-S1818, S1820, S1821	ASG1034
CAPACITORS		
C1901		ACH1246
C1914		CCSQCH221J50
C1903		CEAS470M16
C1701, C1908		CEJA100M50
C1910		CEJA220M25
C1907		CEJAR47M50
C1905		CKSQYB102K50
C3701, C3702, C3704		CKSQYB104K25
C1912		CKSQYB221K50
C1916, C3703		CKSQYF104Z25
C1902, C1904, C1906, C1909		CKSQYF473Z50
RESISTORS		
R9997		RA6T683J
R9998, R9999		RA9T683J
R1908, R1911, R1912, R1943-R1945		RD1/6PM102J
R1947, R1948, R1998, R3706		RD1/6PM102J
R3708-R3710		RD1/6PM102J
R1906, R4514, R4524		RD1/6PM222J
R1720-R1722		RD1/6PM332J
R1905, R4513, R4523		RD1/6PM473J
Other Resistors		RS1/10S□□□J
OTHERS		
	9P CABLE HOLDER	51063-0905
	15P CABLE HOLDER	51063-1505
V1901	FL TUBE	AAV7025
	REMOTE RECEIVER UNIT	GP1U28X
CN9101	17P FFC CONNECTOR	HLEM17R-1
CN9102	26P FFC CONNECTOR	HLEM26R-1
	FL HOLDER	VNF1087
X1902	CERAMIC RESONATOR	EFOEC8004A4
EJECT ASSY		
SWITCHES AND RELAYS		
	S1819	ASG1034
ILLUMI ASSY		
SEMICONDUCTORS		
D1751-D1754		GL1EG21
D1755		GL1HS21
RESISTORS		
Other Resistors		RS1/10S□□□J
PACK ASSY		
SEMICONDUCTORS		
IC1202		ICP-N25
IC1201		STK4142-2GP
CAPACITORS		
C1215, C1216		CCSQCH101J50
C1211		CEANP220M50
C1213		CEANP470M50
C1209, C1210, C1212		CEAS100M50
C1207, C1208		CEAS101M25
C1205, C1206		CEJA220M25
C1203, C1204		CKSQYB222K50
C1219		CKSQYB473K25

Mark No.	Description	Parts No.	Mark No.	Description	Parts No.
RESISTORS			F6205		ATF1152
R1209-R1212, R1216, R1217		RD1/4PM222J	F6202 (450kHz)		ATF1155
R1207, R1208		RD1/4PM563J	L6107 (2.2μH)		ATH1043
R1213, R1214		RD1/4PMFL101J	L6202, L6203, L6208		LCTA2R2J3225
R1215		RD1/4PMFL102J	L6205		LCTA680J3225
R1218		RD1/4PMFL471J	CAPACITORS		
Other Resistors		RS1/10S□□□J	C6204, C6234, C6236, C6269 (1μF/16V)		ACG1051
OTHERS			C6120		CCSCH060D50
10P CABLE HOLDER		51063-1005	C6229		CCSCH102J50
PRI. ASSY			C6111, C6122		CCSQCH010C50
COILS AND FILTERS			C6112		CCSQCH020C50
L1101		ATF-163	C6118		CCSQCH080D50
CAPACITORS			C6113		CCSQCH101J50
C1101 (0.01μF/250V)		ACG7005	C6116, C6208, C6221, C6222		CCSQCH150J50
OTHERS			C6117		CCSQCH330J50
H1101, H1102 TAPING FUSE HOLDER		VKR1001	C6272		CCSQSL330J50
H.P. ASSY			C6105		CCSQSL471J50
COILS AND FILTERS			C6101		CCSQTH110J50
L1231		PTL1014	C6119		CCSQTH150J50
CAPACITORS			C6109		CCSQTH270J50
C1231, C1232		CKSQYB102K50	C6107, C6110		CCSQTH300J50
OTHERS			C6106		CCSQTH330J50
7P CABLE HOLDER		51063-0705	C6261		CEAS010M50
CN1231	CHIP CAPACITOR	AKN1028	C6224, C6231, C6233, C6246, C6262		CEAS100M50
FM/AM TUNER MODULE			C6227		CEAS101M10
SEMICONDUCTORS			C6216, C6217		CEAS330M16
IC6201		LA1836M	C6219		CEAS470M10
IC6202		LM7001J	C6243-C6245		CEAS470M16
Q6102		2SC2223	C6238, C6248		CEJA100M16
Q6203		2SC2235	C6249, C6250		CEJA4R7M35
Q6202, Q6218		2SC2712	C6215		CFTXA103J50
Q6103, Q6214		2SC2714	C6214		CFTXA224J50
Q6201		2SK208	C6115, C6125, C6126, C6207		CKSQYB102K50
Q6104, Q6105		2SK302	C6102, C6114, C6121, C6124, C6210		CKSQYB103K50
Q6101		3SK194	C6264		CKSQYB103K50
Q6204		XDA124EK	C6247		CKSQYB122K50
Q6217		XDC124EK	C6213		CKSQYB223K50
D6101-D6104		1SV228	C6230		CKSQYB273K50
COILS AND FILTERS			C6228		CKSQYB472K50
L6106		ATC1003	C6209, C6237, C6267		CKSQYB473K50
L6105		ATC1015	C6251, C6252		CKSQYB562K50
L6101		ATC1016	C6212, C6218		CKSQYF103Z50
L6102		ATC1017	C6220, C6226, C6239, C6242		CKSQYF223Z50
L6103		ATC1018	C6255, C6256		CKSQYF223Z50
L6104		ATC1019	C6235		CKSQYF224Z25
L6207 (10.7MHz)		ATE1013	C6225, C6241		CKSQYF473Z50
F6204		ATF-107	C6123		CKSYB103K50
F6203		ATF-119	C6232		CKSYB273K50
X6202 (450kHz)		ATF1027	C6223		CKSYF103Z50
			C6263		CKSYF473Z50
			RESISTORS		
			R6299, R6300		RD1/6PM102J
			R6115, R6119, R6123, R6127, R6129		RS1/8S000J
			R6268-R6271, R6275, R6276, R6278		RS1/8S000J
			R6283, R6284, R6293, R6294, R6297		RS1/8S000J
			R6302, R6303		RS1/8S000J
			R6243, R6244		RS1/8S101J
			R6211, R6239		RS1/8S103J
			R6237		RS1/8S122J
			R6209		RS1/8S221J
			R6112		RS1/8S473J

XR-P160

Mark No.	Description	Parts No.
	VR6201 (10kΩ) VR6202 Other Resistors	ACP1056 VRTB6VS223 RS1/10S□□□J
OTHERS		
	BN6201 2P TERMINAL WITH PAL CN6201 14P SOCKET X6203 (7.200MHz) X6201 (456kHz)	AKA1017 KP200IA14L ASS1042 ASS1066
SENSOR BOARD ASSY		
SEMICONDUCTORS		
	Q601, Q602	PS3062
RESISTORS		
	All Resistors	RD1/6PM□□□J
LED BOARD ASSY		
SEMICONDUCTORS		
	D601, D602	AN306
RESISTORS		
	All Resistors	RD1/6PM□□□J
SW BOARD ASSY		
SWITCHES AND RELAYS		
	S601	DSG1017
MOTOR BOARD ASSY		
MOTOR BOARD ASSY has no service part.		
MECHANISM BOARD ASSY		
SWITCHES AND RELAYS		
	S610	DSG1016
OTHERS		
	CN610 MT CONNECTOR (4P)	173979-4

■ FOR XR-P160/DD

Mark No.	Description	Parts No.
----------	-------------	-----------

LIST OF PCB ASSEMBLIES

NSP	COMP. ASSY	AWM7198
	└ AF ASSY	AWZ8106
	└ VOL. ASSY	AWZ8108
	└ SEC. ASSY	AWZ8110
	└ DISP. ASSY	AWZ8113
	└ ILLUMI. ASSY	AWZ8115
	└ EJECT ASSY	AWZ8116
	└ PACK ASSY	AWZ8118
	└ PRI. ASSY	AWZ8121
NSP	└ H.P. ASSY	AWZ8299

	FM/AM TUNER MODULE	AXQ3112
--	--------------------	---------

NSP	CD SLOT-IN MECHANISM UNIT	AXA7014
NSP	└ SL MECHANISM BOARD ASSY	AWX7007
NSP	└ └ SENSOR BOARD ASSY	AWZ7328
NSP	└ └ LED BOARD ASSY	AWZ7329
NSP	└ └ SW BOARD ASSY	AWZ7330
NSP	└ └ MOTOR BOARD ASSY	AWZ7331
NSP	└ SERVO MECHANISM ASSY SL	AXA7017
NSP	└ MECHANISM BOARD ASSY	PWX1192

AF ASSY

SEMICONDUCTORS

	IC4101	BU4066BCF
	IC1981, IC1982	BU4094BCF
	IC4401	CXA1101P
	IC8151	CXA1372Q
	IC8301	CXD2508AQ
⏏	IC8201, IC8202	LA6520
⏏	IC1004	NJM78M12FA
⏏	IC1003	NJM78M56FA
	IC2201	PM0006A
	IC2102, IC3702, IC4102, IC4301, IC8401	XRA4558F-P
	IC2101	XRU4052BCF
	Q1004, Q1007, Q1011, Q1254, Q1981	2SA1037K
	Q4351	2SB1197K
	Q1010, Q1051	2SB1238X
	Q1001	2SB1375
	Q1013	2SC2235
	Q4356	2SC2240
	Q1003, Q1005, Q1008, Q1253	2SC2412K
	Q1255, Q1256, Q1501, Q1502	2SC2412K
	Q4101, Q4102, Q4203-Q4206	2SC2412K
	Q4301, Q4302, Q4401, Q4402	2SC2412K
	Q4451-Q4454, Q8401, Q8402	2SC2412K
	Q1009, Q4353, Q4354	2SD1781K
	Q1002	2SD2012
	Q4355	2SD2144S
	Q8301	2SK246
	Q4307, Q4308	2SK373
	Q1006, Q1241, Q1503, Q4357, Q4403	DTA124EK
	Q4457, Q4458, Q4691	DTA124EK
	Q1251, Q4208, Q4456, Q8302	DTA143EK
	Q8403, Q8404	DTA143EK
	Q4305, Q4306, Q4692	DTC124EK
	Q1252, Q4207, Q4352, Q4455	DTC143EK
	D4301-D4304	1SS135
⏏	D1054	1SS254
	D1251, D1981-D1985, D4201, D4202	1SS254
	D4305, D4306, D4451, D4452, D4601	1SS254
⏏	D4691-D4693	1SS254
	D8301, D8302	1SS254

XR-P160

Mark	No.	Description	Parts No.
	CN2102	14P PLUG	KM200IB14
	CN1232	7P JUMPER CONNECTOR	KPE7
	D1018-D1020	ZINER DIODE	MTZJ8.2A
	JA2101	PIN JACK 2P	RKB1041
	JA9001	REMOTE CONTROL JACK	RKN1004
	D4551-D4553	DIODE	S5688G
		PCB BINDER	VEF1008
	JA1301	PIN JACK 2P	VKB1060
	CN8201	6P SIDE POST	VKN-004

VOL. ASSY

SEMICONDUCTORS

IC1501 XRA4558F-P

CAPACITORS

C1503, C1504 CEAS2R2M50
 C1557, C1558 CKSQYB104K25
 C1550 CKSQYF104Z25
 C1507, C1508 CKSQYF473Z50

RESISTORS

VR1501 (100K-3B x 2) ACX1089
 Other Resistors RS1/10S□□□J

OTHERS

CN1502 10P SOCKET KP200IB10L

SEC. ASSY

SEMICONDUCTORS

IC1006 ICP-N25
 IC1001, IC1002 ICP-N50
 Q1061 2SC2412K
 D1016, D1017, D1061, D1062 1SS254
 D1001-D1004, D1201-D1204 S5688G

CAPACITORS

C1002 CEAS102M16
 C1051 CEAS220M63
 C1001 CEAS222M16
 C1061 CEAS2R2M50

RESISTORS

All Resistors RS1/10S□□□J

OTHERS

10P CABLE HOLDER 51063-1005

DISP. ASSY

SEMICONDUCTORS

IC3701 BA3835F
 IC1902 BU4094BCF
 IC1901 PDG165A
 IC2501 XRA4558F-P
 Q1706-Q1708, Q1751, Q1752, Q4511 2SA1037K
 Q4521 2SA1037K
 Q4501 2SB1197K
 Q1901 2SC2412K
 Q4512, Q4522 2SD1781K
 Q1903, Q4513, Q4523 DTA124EK
 Q1904 DTC124EK
 Q1701-Q1704, Q1753, Q1902, Q4502 DTC143EK
 D1801-D1812, D1901-D1903 1SS254
 D1905, D1906, D1910, D4501 1SS254
 D4511-D4514, D4521-D4526 1SS254

Mark	No.	Description	Parts No.
	D1796, D1798		BR5064X
	D1791-D1795, D1797		MPG5064X
	D1904		MTZJ6.2B
	COILS AND FILTERS		
	L1901		LAU220J
	SWITCHES AND RELAYS		
	S1801-S1818, S1820, S1821		ASG1034

CAPACITORS

C1901 ACH1246
 C2504 CCSQCH221J50
 C1903 CEAS470M16
 C1701, C1908, C2503, C2505, C2510 CEJA100M50
 C1910 CEJA220M25

C1907 CEJAR47M50
 C1905 CKSQYB102K50
 C3701, C3702, C3704 CKSQYB104K25
 C2501 CKSQYB122K50
 C1912 CKSQYB221K50

C2511 CKSQYB472K50
 C2507, C2508 CKSQYB473K25
 C2506 CKSQYB682K50
 C3703 CKSQYF104Z25
 C1902, C1904, C1906, C1909 CKSQYF473Z50

RESISTORS

R9997 RA6T683J
 R9998, R9999 RA9T683J
 R1908, R1911, R1912, R1943-R1945 RD1/6PM102J
 R1947, R1948, R1998, R3706 RD1/6PM102J
 R3708-R3710 RD1/6PM102J

R1906, R4514, R4524 RD1/6PM222J
 R1720-R1722 RD1/6PM332J
 R1905, R4513, R4523 RD1/6PM473J
 VR2501(10K-B) ACS1048
 Other Resistors RS1/10S□□□J

OTHERS

V1901 9P CABLE HOLDER 51063-0905
 JA2501 15P CABLE HOLDER 51063-1505
 C1914 FL TUBE AAV7025
 VARIABLE(10K x 1) AKN7004
 CHIP CERAMIC C. CCSQCH221J50

C1916 CERAMIC CAPACITOR CKSQYF104Z25
 Q1801 CHIP DIGITAL TRANS. DTA124EK
 REMOTE RECEIVER UNIT GP1U28X
 CN9101 17P FFC CONNECTOR HLEM17R-1
 CN9102 26P FFC CONNECTOR HLEM26R-1

L2501 AXIAL INDUCTOR LAU100J
 FL HOLDER VNF1087
 X1902 CERAMIC RESONATOR EFOEC8004A4

ILLUMI. ASSY

SEMICONDUCTORS

D1751, D1752 GL1EG21
 D1753, D1754 GL1HS21
 D1755 GL1PR21

RESISTORS

All Resistors RS1/10S□□□J

EJECT ASSY

SWITCHES AND RELAYS

S1819 ASG1034

Mark No.	Description	Parts No.	Mark No.	Description	Parts No.
PACK ASSY			F6203, F6204		ATF-119
SEMICONDUCTORS			F6101		ATF-155
⊥	IC1202	ICP-N25	F6202 (450kHz)		ATF1155
⊥	IC1201	STK4142-2GP	L6103 (2.2 μH)		ATH1043
			L6202, L6203, L6208		LCTA2R2J3225
CAPACITORS			CAPACITORS		
C1211		CEANP220M50	C6202, C6234, C6236 (1μF/16V)		ACG1051
C1213		CEANP470M50	C6107		CCSCH010C50
C1209, C1210, C1212		CEAS100M50	C6229		CCSCH821J50
C1207, C1208		CEAS101M25	C6110		CCSQCH020C50
C1205, C1206		CEJA220M25	C6101		CCSQCH050C50
C1203, C1204		CKSQYB222K50	C6108, C6203, C6268		CCSQCH101J50
RESISTORS			C6111, C6116, C6208, C6221, C6222		CCSQCH150J50
R1209-R1212, R1216, R1217		RD1/4PM222J	C6115		CCSQCH330J50
R1207, R1208		RD1/4PM563J	C6114		CCSQRH080D50
R1213, R1214		RD1/4PMFL101J	C6113		CCSQRH180J50
R1215		RD1/4PMFL102J	C6105		CCSQTH150J50
R1218		RD1/4PMFL471J	C6261		CEAS010M50
Other Resistors		RS1/10S□□□J	C6224, C6246, C6262		CEAS100M50
			C6227		CEAS101M10
			C6216, C6217		CEAS330M16
OTHERS			C6231, C6233		CEAS3R3M50
	10P CABLE HOLDER	51063-1005	C6219		CEAS470M10
PRI. ASSY			C6243-C6245		CEAS470M16
SWITCHES AND RELAYS			C6238		CEJA100M16
⊥	S1101	AKX7003	C6249, C6250		CEJA4R7M35
CAPACITORS			C6215		CFTXA103J50
⊥	C1101 (0.01μF/250V)	ACG7005	C6214		CFTXA224J50
OTHERS			C6103, C6106, C6112, C6204		CKSQYB102K50
	H1101-H1104	VKR1001	C6102, C6109, C6117, C6210, C6264		CKSQYB103K50
			C6213		CKSQYB223K50
			C6230		CKSQYB333K50
			C6228, C6252		CKSQYB472K50
			C6209, C6237, C6265, C6267		CKSQYB473K50
			C6212, C6218		CKSQYF103Z50
			C6220, C6226, C6239, C6242, C6255		CKSQYF223Z50
H.P. ASSY			C6235		CKSQYF224Z25
RESISTORS			C6225, C6241, C6266		CKSQYF473Z50
	Other Resistors	RS1/10S□□□J	C6232		CKSYB333K50
			C6251		CKSYB472K50
OTHERS			C6223		CKSYF103Z50
	7P CABLE HOLDER	51063-0705	C6263		CKSYF473Z50
CN1231	AKN1028				
FM/AM TUNER MODULE			RESISTORS		
SEMICONDUCTORS			VR6201 (10kΩ)		ACP1056
IC6201		LA1836M	VR6202		VRTB6VS223
IC6202		LM7001J	R6299, R6300		RD1/8PM102J
Q6102		2SC2223	R6113, R6116, R6118, R6268-R6271		RS1/8S000J
Q6203		2SC2235	R6275, R6276, R6278, R6283, R6284		RS1/8S000J
Q6202		2SC2712			
Q6103, Q6214		2SC2714	R6290, R6293, R6294, R6297		RS1/8S000J
Q6201		2SK208	R6243, R6244		RS1/8S101J
Q6104		2SK302	R6211		RS1/8S103J
Q6101		3SK194	R6237		RS1/8S182J
Q6204		XDA124EK	R6209		RS1/8S221J
Q6217		XDC124EK	R6239		RS1/8S332J
D6101, D6102		1T33	R6101		RS1/8S470J
			Other Resistors		RS1/10S□□□J
COILS AND FILTERS			OTHERS		
L6104		ATC1003	BN6201	TERMINAL 4-P	AKA1016
L6101		ATC1020	X6203 (7.200MHz)		ASS1042
L6102		ATC1021	X6201 (456kHz)		ASS1066
T6101		ATE-063	X6202 (450kHz)		ATF1027
L6207 (10.7MHz)		ATE1013		AM RF TUNING BLOCK	AXX1025
			CN6201	14P SOCKET	KP200IA14L

XR-P160

Mark No.	Description	Parts No.
SENSOR BOARD ASSY		
	SEMICONDUCTORS	
	Q601, Q602	PS3062
	RESISTORS	
	All Resistors	RD1/6PM□□□J
LED BOARD ASSY		
	SEMICONDUCTORS	
	D601, D602	AN306
	RESISTORS	
	All Resistors	RD1/6PM□□□J
SW BOARD ASSY		
	SWITCHES AND RELAYS	
	S601	DSG1017
MOTOR BOARD ASSY		
	MOTOR BOARD ASSY has no service part.	
MECHANISM BOARD ASSY		
	SWITCHES AND RELAYS	
	S610	DSG1016
	OTHERS	
	CN610 MT CONNECTOR (4P)	173979-4

5. ADJUSTMENTS

5.1 TUNER SECTION

■ FM Tuner Section

- Set the mode selector to FM BAND.
- Connect the wiring as shown in Fig. 1-1.
- For DD type (AXQ3112)

Step No.	Adjustment Title	FM SG (1kHz, ± 75 kHz dev.)		Reception Frequency Display	Adjustment Location	Specifications
		Frequency (MHz)	Level (dB μ V)			
1	Center Adjustment	98 Non modulation	80 or more	98MHz	L6207	Adjust so that the DC voltage between IC6201-Pin 4 and Pin 28 (or \oplus leads of C6224 and C6261) becomes 0V \pm 50mV.
2	Front End Sencitivity	98	0-30	98MHz	L6102 T6101	Adjust so that the DC voltage between the IC6201-Pin 12 and GND (or \oplus leads of C6238 and GND) becomes at maximum level.
3	Stereo Distortion	98	80	98MHz	T6101	Minimize the distortion with 1/8 rotation of the core.
4	TUNED IND. Lighting Level	98	15 \pm 2	98MHz	VR6201	Adjust so that the indicator of TUNED IND. starts to light up.

Notes:

- Before adjusting, make sure there is no gap between L6101 and L6102. If there is a gap between them, bring them into contact with each other first, and then make adjustments.
- Make indicator adjustments in order of AM \rightarrow FM.

- For NVXK, MYIXK, MYXK/EA and MYXK/EB types (AXQ3214)

Step No.	Adjustment Title	FM SG (1kHz, ± 75 kHz dev.)		Reception Frequency Display	Adjustment Location	Specifications
		Frequency (MHz)	Level (dB μ V)			
1	Center Adjustment	98 Non modulation	80 or more	98MHz	L6207	Adjust so that the DC voltage between IC6201-Pin 4 and Pin 28 (or \oplus leads of C6224 and C6261) becomes 0V \pm 50mV.
2	Front End Sencitivity	106	0-30	106MHz	L6104 L6105 L6102 T6101	After adjusting L6104 and L6105 so that the DC voltage between LC6201-Pin12 and GND (or \oplus leads of C6238 and GND) becomes at maximum level, adjust T6101 and L6102.
3	Stereo Distortion	98	80	98MHz	T6101	Minimize the distortion with 1/8 rotation of the core.
4	TUNED IND. Lighting Level	98	15 \pm 2	98MHz	VR6201	Adjust so that the indicator of TUNED IND. starts to light up.

Notes:

- Before adjusting, make sure there is no gap between L6101 and L6102 and between L6103 and L6104. If there is a gap between them, bring them into contact with each other first, and then make adjustments.
- Make indicator adjustments in order of AM \rightarrow FM.
- Adjustment sequence: L6104 \rightarrow L6105 \rightarrow L6102 \rightarrow T6101

■ AM Tuner Section

- Set the mode selector to AM BAND.
- Connect the wiring as shown in Fig. 1-1.
- For NVXK, MYIXK, MYXK/EA, MYXK/EB and DD types (AXQ3112 and AXQ3214)

Step No.	Adjustment Title	AM SG (400Hz, 30% Mod.)		Reception Frequency Display	Adjustment Location	Specifications
		Frequency (kHz)	Level (dB μ V/m)			
1	TUNED IND. Lighting Level	999 *1	47 \pm 2	999kHz *1	VR6202	Adjust so that the indicator of TUNED IND. starts to light up.

Notes:

- When DD type is used, set the AM frequency step to 10 kHz.
- *1: For the area using 10kHz step, frequencies should be 1000 kHz

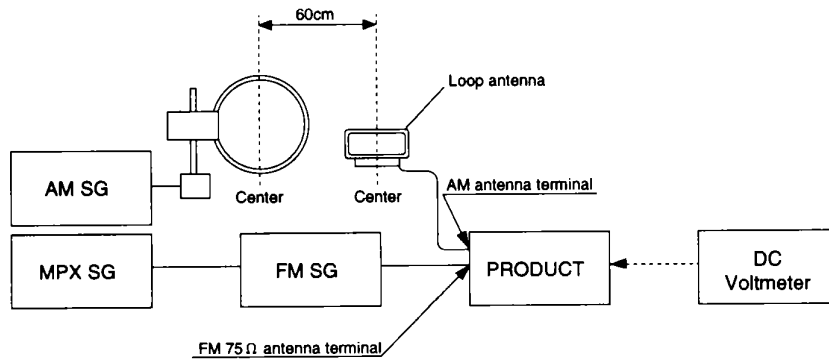
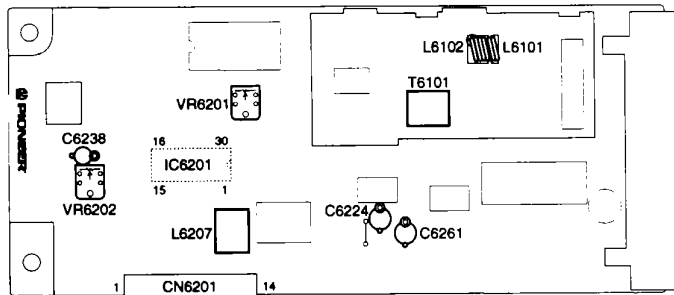

Fig. 1-1 AM and FM Adjustment Wiring Diagram

FM/AM TUNER MODULE (AXQ3112)



FM/AM TUNER MODULE (AXQ3214)

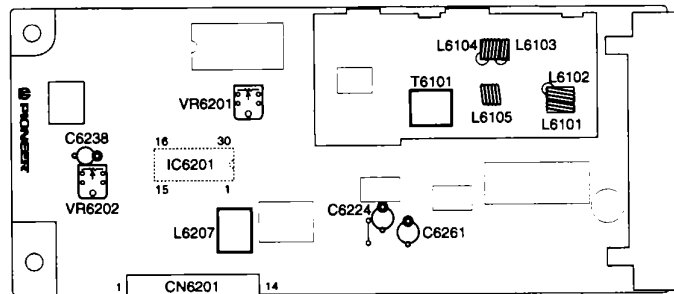

Fig. 1-2 Adjustment Points

5.2 CASSETTE DECK SECTION

● Adjustment points and test points are shown in Fig. 2-2 and Fig. 2-5.

■ Mechanical Adjustment

- Set the TAPE function.
- Test tape: STD-301 (3kHz, 30min).

1. Tape Speed Adjustment

No.	Mode	Test Tape	Adjusting Points	Measurement Points	Adjustment Procedure	Remarks
1	Deck I PLAY	STD-301 (Playback: 3kHz)	AF Assy VR4501	TAPE TEST POINT (Rch) (AF Assy)	Press the PLAY SW and adjust so that the reading becomes 3000Hz ±20Hz. Confirm that wow & flutter level is below 0.2% (in the reverse direction, confirm that the reading is within 3000Hz ±60Hz).	

■ Electrical Adjustment

Check the following before starting.

1. Confirm that the tape speed adjustment has been completed.
2. Clean the heads and demagnetize them using a head eraser.
3. Set the measurement level to 0 dBV = 1 Vrms.
4. Use the specified tape for adjustment. Use the labeled (A) side of the test tape.
STD-331E: For playback adjustment
STD-631or STD-632: Normal blank tape
5. Provide yourself with the following measuring devices:
 - AC millivoltmeter
 - Low-frequency oscillator
 - Attenuator
 - Oscilloscope
6. Adjust both right and left channels unless otherwise specified.
7. Turn the DOLBY NR switch off unless otherwise specified.
8. Warm up the unit for several minutes before adjustment. In particular, be sure to warm up the unit in the REC/PLAY mode for 3 to 5 minutes before starting recording/playback frequency characteristics adjustment.
9. Always follow the indicated adjustment order. Otherwise, a complete adjustment may not be achieved.

Playback Adjustment (Decks I and II)

1. Head Azimuth Adjustment
2. Playback Level Adjustment

Recording Adjustment (Deck II)

1. Bias Oscillation Frequency Adjustment
2. Recording Bias Adjustment
3. Recording Level Adjustment.
4. ALC Operation Check

* As the reference recording level is 250nwb/m for STD-331E, the recording level will be higher by 4 dB for STD-331B (160nwb/m). When adjusting, pay carefull attention to the type of tape used.

Dolby noise reduction manufactured under license from Dolby Laboratories Licensing Corporation.
"DOLBY" and the double-D symbol are trademarks of Dolby Laboratories Licensing Corporation.

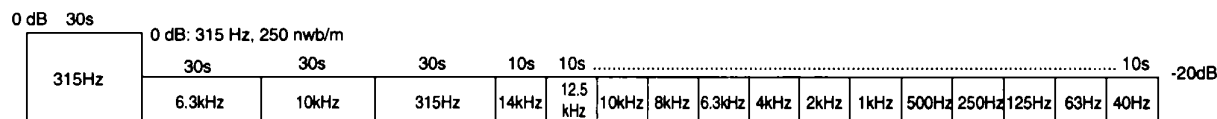

Fig. 2-1 STD-331E Test Tape

■ Playback Adjustment

1. Head Azimuth Adjustment

- This unit is equipped with auto tape selector.
- Do not switch between forward and reverse operation with the screwdriver inserted.

Step	Tape Selector (AUTO)	Mode	Input Signal/ Test Tape	Adjusting Points	Measurement Points	Adjustment Value	Remarks
1	NORMAL	PLAY	STD-331E test tape (Playback: 10kHz, -20dB)	Deck I	Tape TEST POINT (L, Rch) (AF Assy)	Max. playback signal level	After adjustment, apply silicon bond to the head azimuth adjustment screw.
				Deck II			

2. Playback Level Adjustment

- Since this adjustment determines playback Dolby NR level, perform it carefully.

Step	Tape Selector (AUTO)	Mode	Input Signal/ Test Tape	Adjusting Points	Measurement Points	Adjustment Value	Remarks
1	NORMAL	PLAY	STD-331E test tape (Playback: 315Hz, 0dB)	Deck I	Tape TEST POINT (L, Rch) (AF Assy)	-4.2 dBV	
				Deck II			

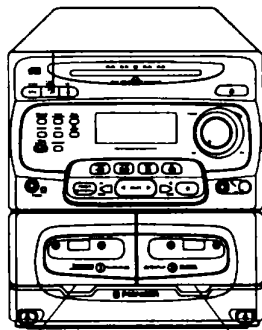

Mecha I Adjusting Hole Mecha II Adjusting Hole

Fig. 2-2

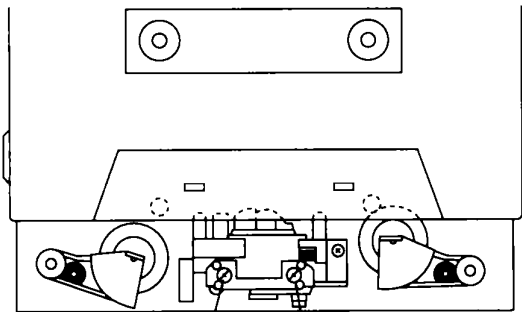

FWD Azimuth Adjustment Screw REV Azimuth Adjustment Screw

Fig. 2-3 Head Azimuth Adjustment

PLAY BACK

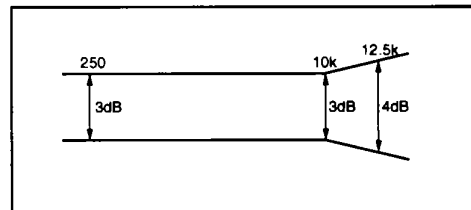

RECORDING

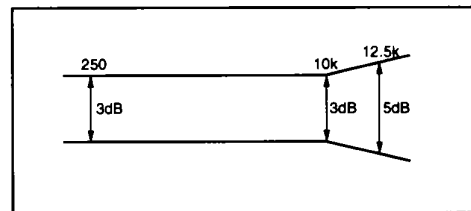

Fig. 2-4 Frequency Characteristics

■ Recording Adjustment

1. Bias Oscillation Frequency Adjustment

Step	Tape Selector (AUTO)	Mode	Input Signal/ Test Tape	Adjusting Points		Measurement Points	Adjustment Value	Remarks
1	NORMAL	REC	Load the STD-631 or STD-632 test tapes and set the recording mode.	Deck I	——	Between ① point in Fig. 2-5 and GND.	Oscillation frequency to be 105.0kHz ±2kHz.	When the power is turned ON while the MONO button is depressed, the frequency will decrease 2 - 3 kHz.
				Deck II	L4351			

● After the adjustment, caution should be exercised so as not to become under bias by checking the distortion rate.

2. Recording Bias Adjustment

Step	Tape Selector (AUTO)	Mode	Input Signal/Test Tape	Adjusting Points		Measurement Points	Adjustment Value	Remarks
1	NORMAL	REC	Input a 315Hz signal to the MD/CDII terminal and set the input selector to MD/CDII.	Deck I	——	TAPE TEST POINT (L, Rch) (AF Assy)	- 25.2 dBV	
				Deck II	Input signal level			
2	NORMAL	REC→PLAY	Load the STD-631 or STD-632 test tapes and record/playback the 315Hz and 10kHz signals. (see the Note below)	Deck I	——	TAPE TEST POINT (L, Rch) (AF Assy)	Repeat adjustment until playback level of the 10kHz signal is within 0±0.5dB from that of the 315Hz signal.	
				Deck II	VR4351 (Lch) VR4352 (Rch)			

Note: Set the 10kHz input signal level to the same value as the 315Hz input signal level of step 1.

3. Recording Level Adjustment

Step	Tape Selector (AUTO)	Mode	Input Signal/Test Tape	Adjusting Points		Measurement Points	Adjustment Value	Remarks
1	NORMAL	REC	Input a 315Hz signal to the MD/CDII terminal and set the input selector to MD/CDII.	Deck I	Input signal level	TAPE TEST POINT (L, Rch) (AF Assy)	- 8.2 dBV	
				Deck II				
2	NORMAL	REC→PLAY	STD-631 or STD-632 test tape and record/playback the 315Hz signal.	Deck I	——	TAPE TEST POINT (L, Rch) (AF Assy)	Repeat recording, playback and adjustment until playback level of the 315Hz signal becomes -8.2dBV.	
				Deck II	VR4301 (Lch) VR4302 (Rch)			

4. ALC Operation Check

Step	Tape Selector (AUTO)	Mode	Input Signal/Test Tape	Adjusting Points		Measurement Points	Adjustment Value	Remarks
1	NORMAL	REC / PLAY	Input a 315Hz signal to the MD/CDII terminal and set the input selector to MD/CDII.	Input signal level		TAPE TEST POINT (L, Rch) (AF Assy)	- 8.2 dBV	
2				Set to a level +10 dB above the input level at step 1.	-3.2±2.5 dBV			

AF ASSY

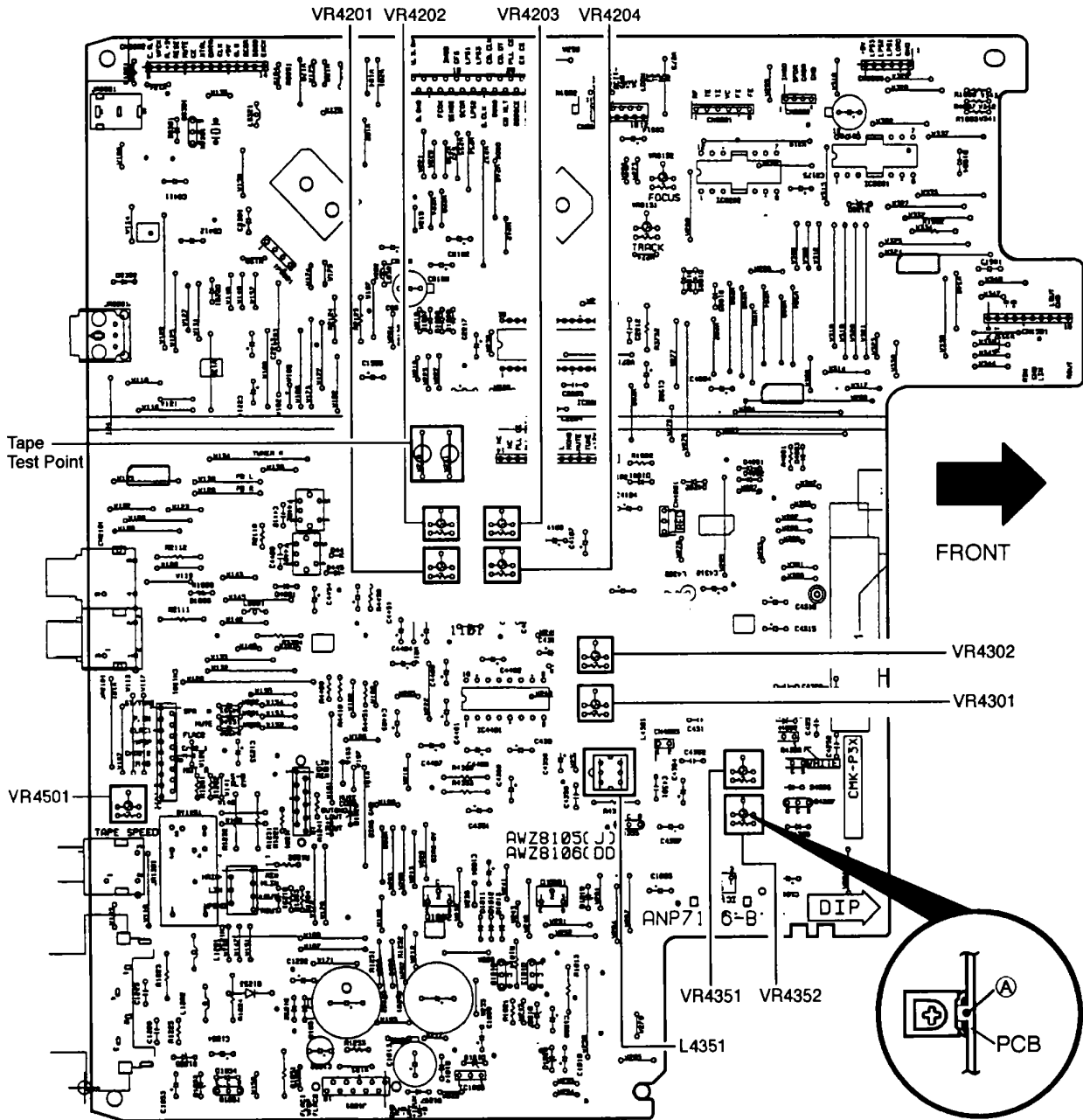







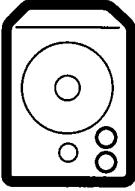
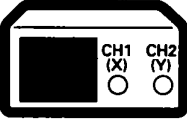
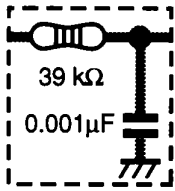

Fig. 2-5 Adjustment Points

5.3 CD SECTION (CD部の調整)

1. PREPARATIONS (準備)

1.1 Jigs and Measuring Instruments (使用測定器/治工具類)

 <p>8-cm DISC (With at least about 20 minutes recording) (20分程度信号の 入ったディスク)</p>	 <p>CD TEST DISC (YEDS-7)</p>	 <p>⊖ Precise screwdriver</p>	 <p>⊖ screwdriver (small)</p>	 <p>⊕ screwdriver (medium)</p>
 <p>Ball point hexagon wrench (size: 1.5mm) GGK1002 ボールポイント付 六角ドラ イバー (対辺 1.5mm)</p>	 <p>⊕ screwdriver (large)</p>	 <p>Low-frequency oscillator</p>	 <p>Dual-trace oscilloscope (10 : 1 probe)</p>	 <p>Low pass filter (39 kΩ + 0.001mF)</p>

1.2 Necessary Adjustment Points (調整に必要な項目)

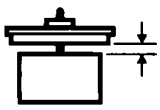
When (このような時)	Adjustment points
Exchange PICKUP (ピックアップを交換した時)	1.2.3.4.5.6. → Page 59~61
Exchange MAIN ASSY (メイン ASSYを交換した時)	1.2.3.4.5.6. → Page 59~61
Exchange SERVO MECH ASSY (サーボメカ ASSYを交換した時)	1.2.3.4.5.6. → Page 59~61
Exchange SPINDOLE MOTOR (スピンドルモーターを交換した時)	 ADJ → Page 13

2. ADJUSTMENT (調整)

2.1 How to Start/Cancel/Test Mode (テストモードの設定/解除)

TEST MODE : ON

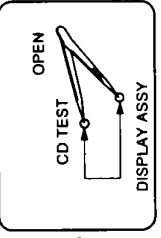
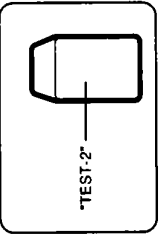
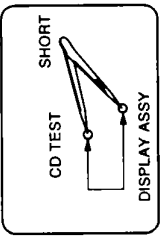
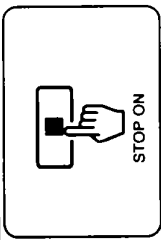
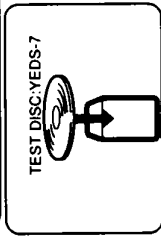

TEST MODE : PLAY

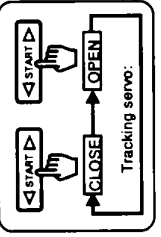
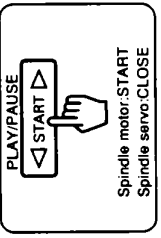
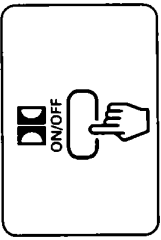
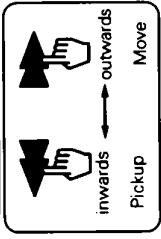

TEST MODE : STOP → CANCEL

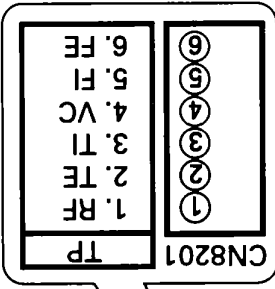
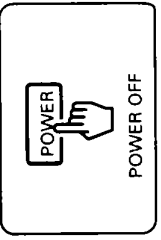
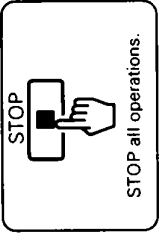

2.2 Adjustment Locations (テストポイントと調整用VRの位置)

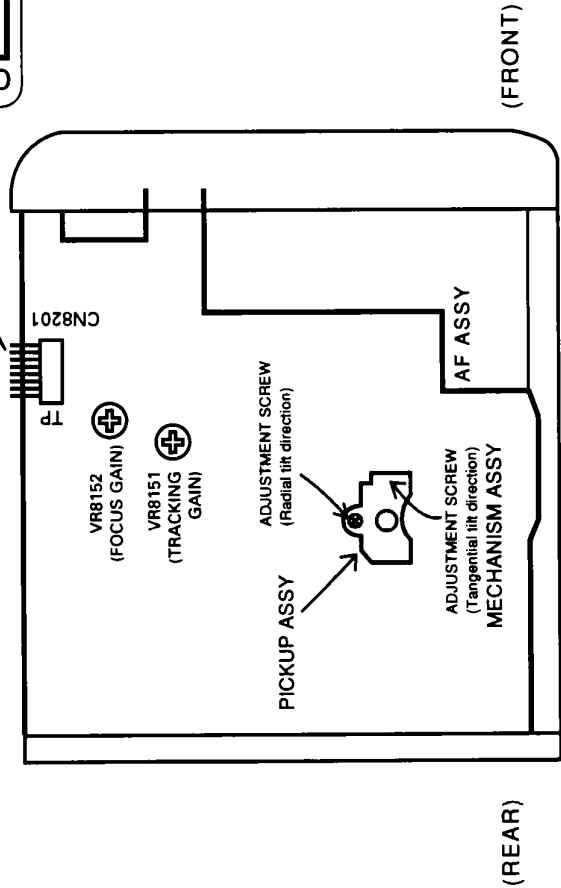
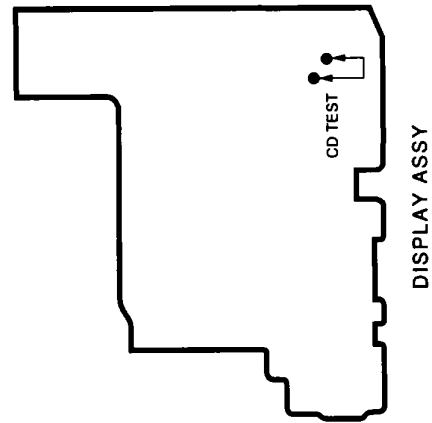

2.3 Check and Adjustment (確認、調整)

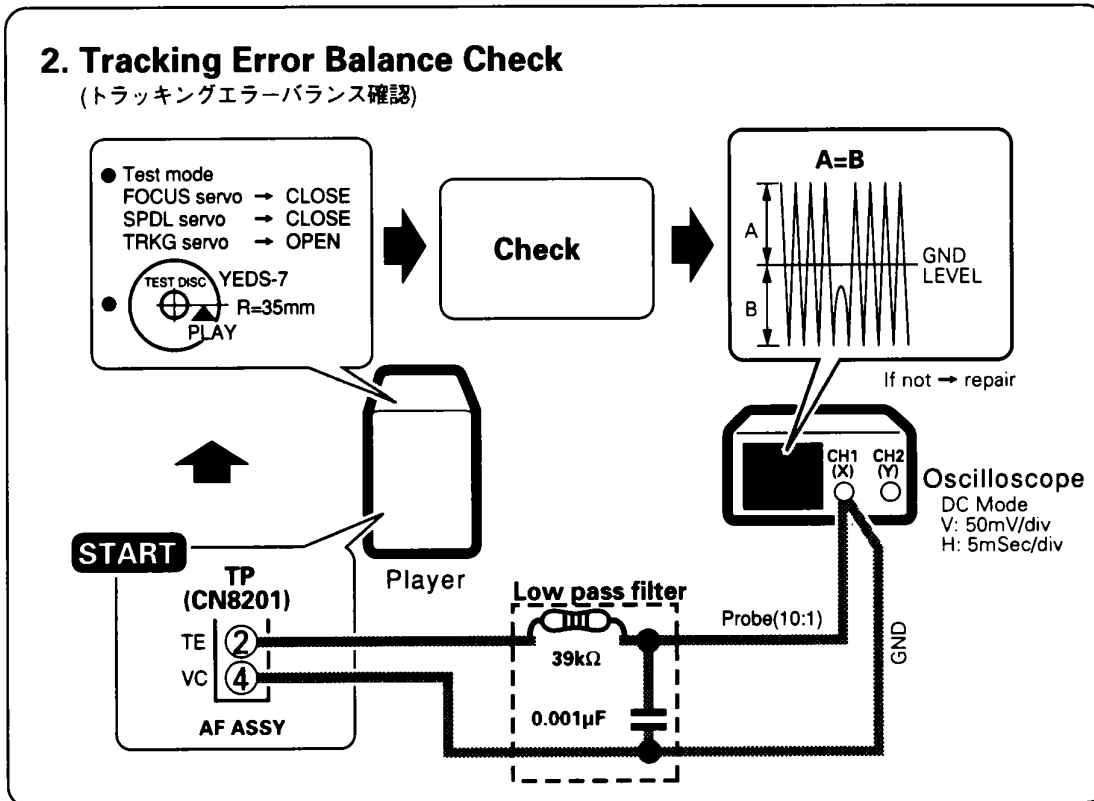
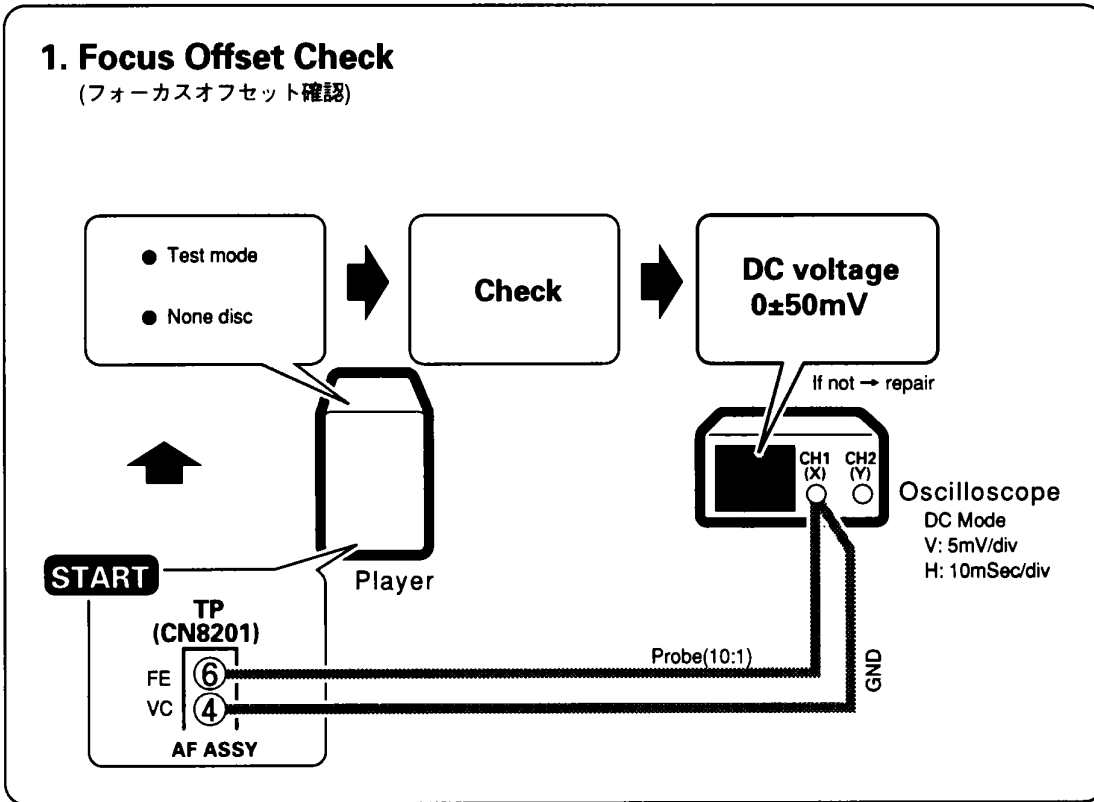

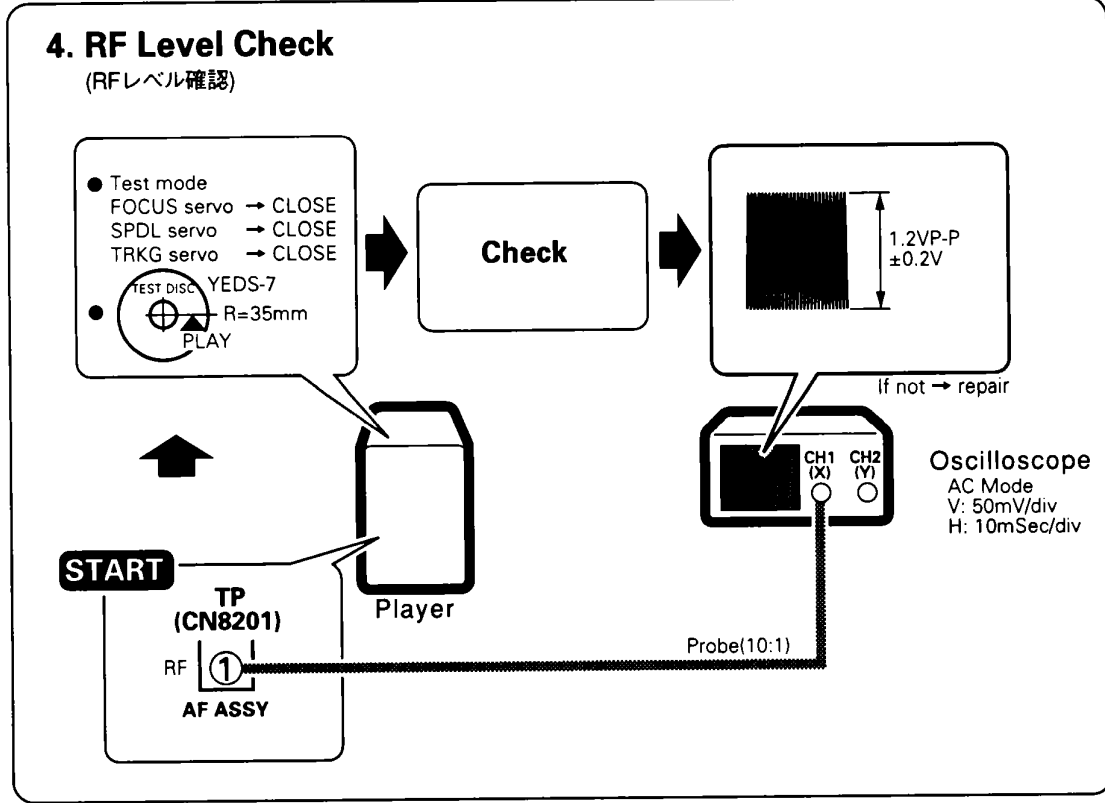
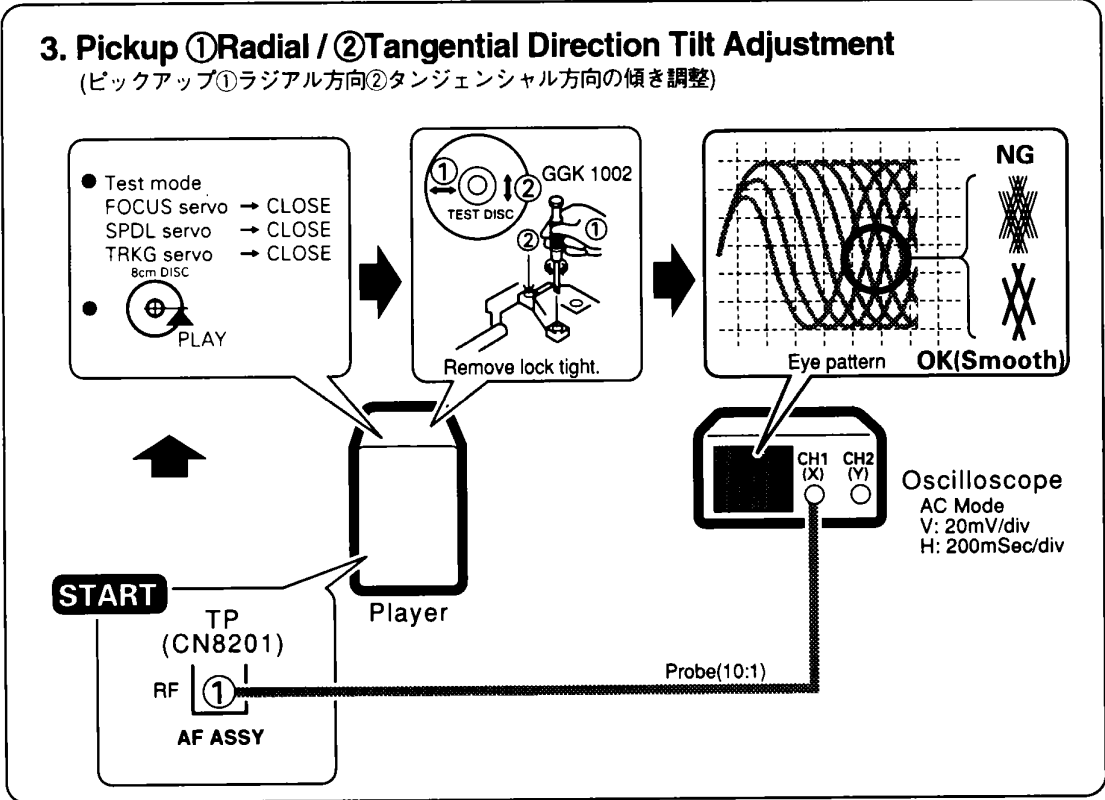

5. FOCUS SERVO LOOP GAIN ADJUSTMENT

(フォーカスサーボループゲイン確認)

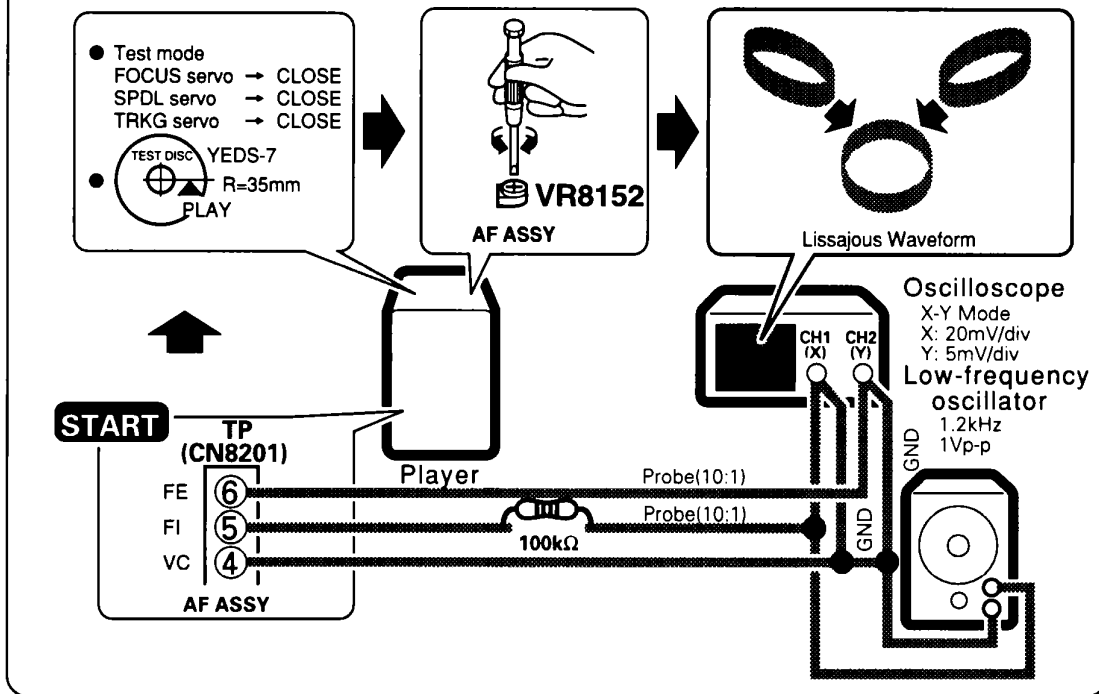

6. TRACKING SERVO LOOP GAIN ADJUSTMENT

(トラッキングサーボループゲイン確認)

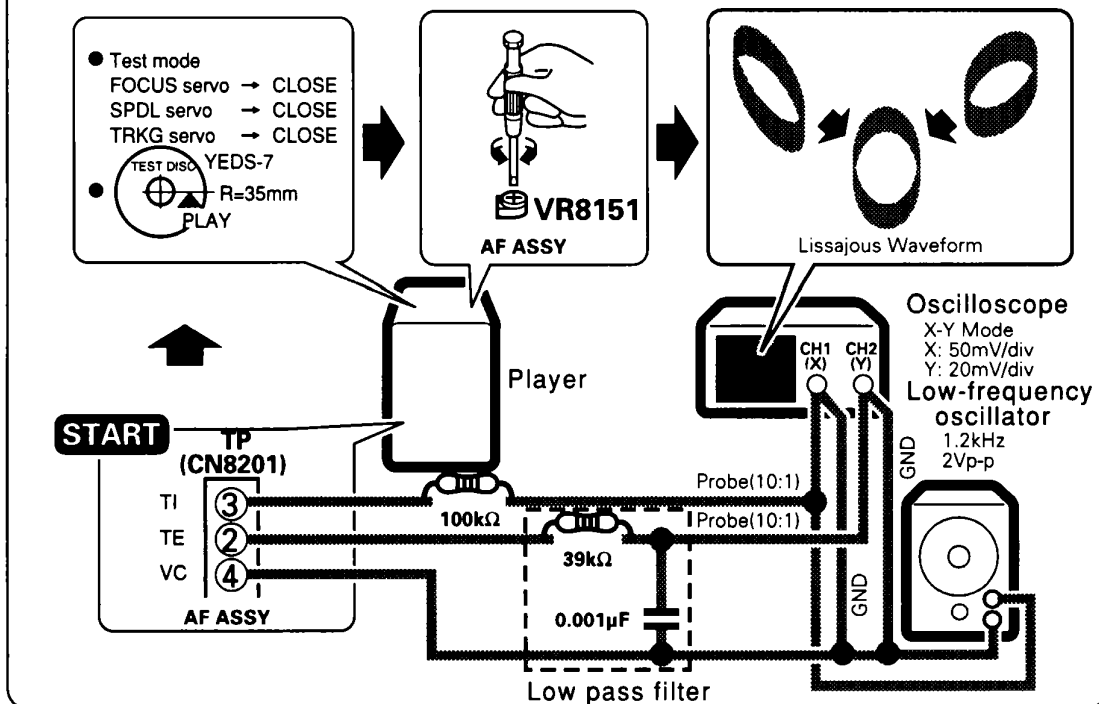

6. IC INFORMATION

- The information shown in the list is basic information and may not correspond exactly to that shown in the schematic diagrams.

■ PDG165A (IC1901 : DISP. ASSY)

- System Control Micro-computer
- Pin Assignment (Top view)

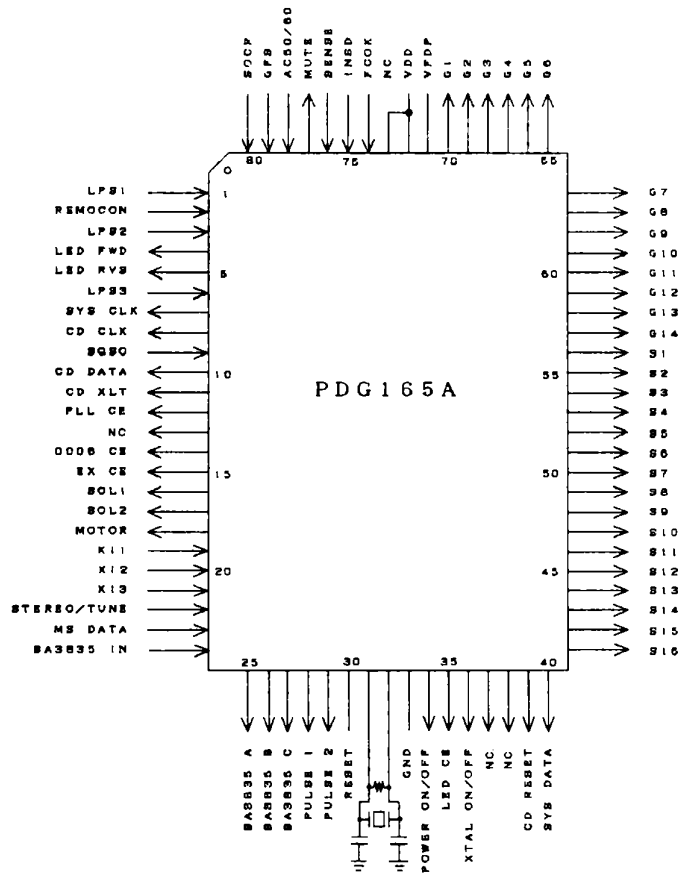

● Pin Function

No	Pin Name	I/O	Description
1	LPS1	I	DISC detection photo 1
2	REMOTE	I	Remote control signal input
3	LPS2	I	DISC detection photo 2
4	LED FWD ▷	O	LED control
5	LED RVS ◁		
6	LPS3	I	DISC clamp completion switch
7	SYS CLK	O	CLK output
8	CD CLK	O	CD decoder clock

No	Pin Name	I/O	Description
9	SQSO	I	DISC time information
10	CD DATA	O	CD decoder DATA output
11	CD XLT	O	CD decoder latch after transmission
12	PLL CE	O	PLL CE output
13	N.C.	-	Not used
14	0006CE	O	PM0006 CE output
15	EX CE	O	BU7094 CE output
16	SOL1	O	DECK mechanism I solenoid control

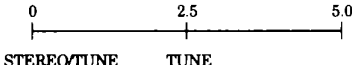
No	Pin Name	I/O	Description
17	SOL2	O	DECK mechanism II solenoid control
18	MOTOR	O	MOTOR ON/OFF
19	KI1	I	Key return input I
20	KI2	I	Key return input II
21	KI3	I	Key return input III
22	STEREO/ TUNE	I	
23	MS DATA	I	MUSIC search
24	BA3835 IN	I	BA3835 input
25	BA3835 A	I	BA3835 A
26	BA3835 B	I	BA3835 B
27	BA3835 C	I	BA3835 C
28	PULSE 1	I	DECK mechanism I operation detection
29	PULSE 2	I	DECK mechanism II operation detection
30	RESET	I	POWER ON RESET
31	EXTL	I	_____
32	XTL		
33	Vss		
34	Power/ON/OFF	O	BU4094 and power supply circuit and P.P muting control
35	LED CE	O	BU4094 (for LED) CE output
36	XTAL ON/OFF	O	CD XTAL ON/OFF
37	N.C.	-	_____
38			
39	CD RESET	O	CD and CDG RESET output
40	SYS DATA	O	PLL, PM0006, BU4094 data
41 56	S16 S1	O	FL segment output
57 70	G14 G1	O	FL grid output
71	VFDP	-	_____
72	VDD		
73	N.C.		

No	Pin Name	I/O	Description
74	FCOK	I	Decoder monitor H. FOCUS OK
75	INSD	I	Pickup home position recognition
76	SENCE	I	Decoder monitor
77	MUTE	O	System mute output
78	AC 50/60	I	_____
79	GFS	I	Decoder monitor, rotation speed frame check
80	SOCR	I	Decoder monitor, Q data interrupt signal

XR-P160

■ BA3835F (IC3701 : DISP. ASSY)

● Display Control Micro-computer

● Pin Assignment (Top view)

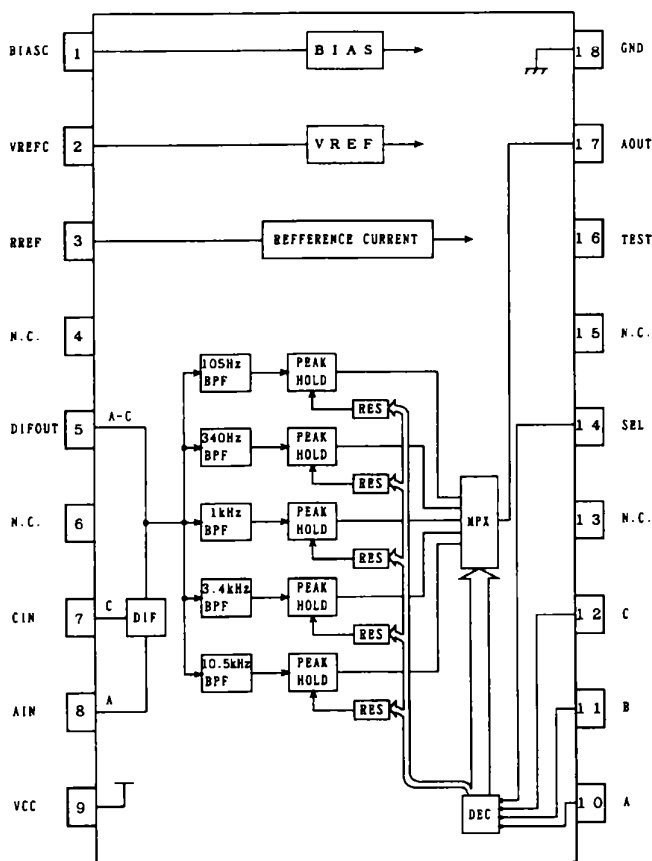

● Pin Function

No	Pin Name	Description
1	BIASC	Decoupling capacitor connection terminal for linear part reference voltage
2	VREFC	Decoupling capacitor connection terminal for logic part reference voltage.
3	RREF	Reference resistor connection terminal for band pass filter to setting. fo adjustment is possible by this external resistor. (However, only entire band shift.)
4	N.C.	Not used
5	DIFOUT	Differential amplifier output terminal OPEN for normal use.
6	N.C.	Not used
7	CIN	Differential amplifier input terminal 2 Connected to the audio system GND via a capacitor.
8	AIN	Differential amplifier input terminal 1. Audio signal input via a capacitor.
9	VCC	Power source
10	A	Output selection control terminal (Refer to the output selection logic table.)
11	B	
12	C	
13	N.C.	Not used
14	SEL	Output selection control terminal (Refer to the output selection logic table.)
15	N.C.	Not used
16	TEST	Test signal input terminal Connected to GND for normal use.
17	AOUT	Multiplexer output terminal One of the five peak hold voltageband a is selected and output is executed. After the ewnd of selection, discharge to a level of peak value minus 3 db is executed by means of a reset pulse.
18	GND	Ground

7. FL INFORMATION

■ AAV7025 (V1901: DISP. ASSY)

● FL TUBE

● Grid Assignment

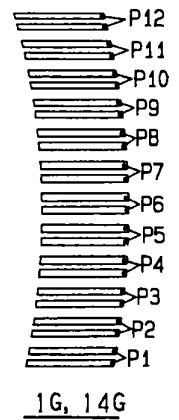
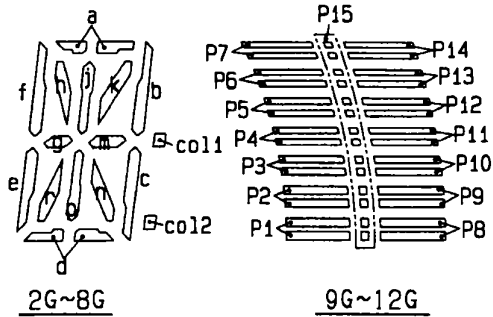
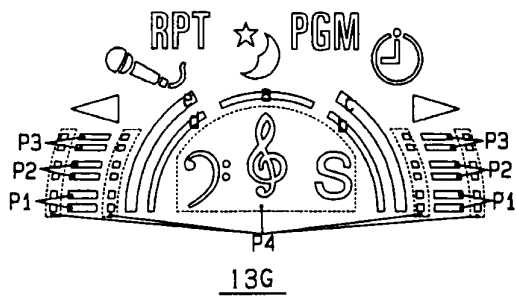
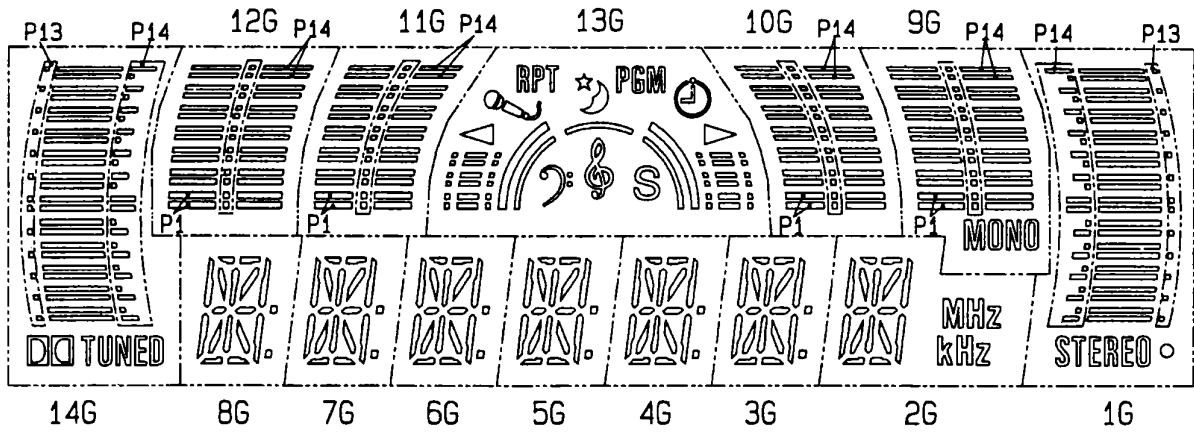

XR-P160

● Anode Assignment

	14G	13G	12G	11G	10G	9G	8G	7G	6G	5G	4G	3G	2G	1G
S1	P1	P1	P1	P1	P1	P1	a	a	a	a	a	a	a	P1
S2	P2	P2	P2	P2	P2	P2	b	b	b	b	b	b	b	P2
S3	P3	P3	P3	P3	P3	P3	j	j	j	j	j	j	j	P3
S4	P4	P4	P4	P4	P4	P4	k	k	k	k	k	k	k	P4
S5	P5	RPT	P5	P5	P5	P5	h	h	h	h	h	h	h	P5
S6	P6	a	P6	P6	P6	P6	f	f	f	f	f	f	f	P6
S7	P7	d	P7	P7	P7	P7	m	m	m	m	m	m	m	P7
S8	P8	e	P8	P8	P8	P8	g	g	g	g	g	g	g	P8
S9	P9	b	P9	P9	P9	P9	c	c	c	c	c	c	c	P9
S10	P10	c	P10	P10	P10	P10	r	r	r	r	r	r	r	P10
S11	P11	Ⓜ	P11	P11	P11	P11	n	n	n	n	n	n	n	P11
S12	P12	Ⓜ	P12	P12	P12	P12	p	p	p	p	p	p	p	P12
S13	P13	Ⓜ	P13	P13	P13	P13	e	e	e	e	e	e	e	P13
S14	P14	PGM	P14	P14	P14	P14	d	d	d	d	d	d	d	P14
S15	Ⓜ	▷	P15	P15	P15	P15	col 1	col 1	col 1	col 1	col 1	col 1	MHz	◦
S16	TUNED	◁				MONO	col 2	col 2	col 2	col 2	col 2	col 2	kHz	STEREO

● Pin Assignment

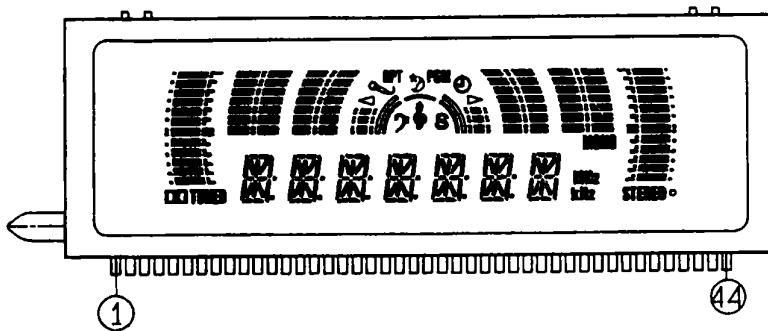

● Pin Connection

Pin No.	1	2	3	4	5	6	7	8	9	10	11	12	13	14	15	16	17	18	19	20	21	22
Assignment	F1	F1	NP	G14	G13	G12	G11	G10	G9	NL	NL	NL	NL	NL	NL	NL	NL	G8	G7	G6	G5	G4
Pin No.	23	24	25	26	27	28	29	30	31	32	33	34	35	36	37	38	39	40	41	42	43	44
Assignment	G3	G2	G1	S1	S2	S3	S4	S5	S6	S7	S8	S9	S10	S11	S12	S13	S14	S15	S16	NP	F2	F2

F1, F2: Filament G1~G14: Grid S1~S16: Anode NL: No Lead NP: No Pin

8. BLOCK DIAGRAM

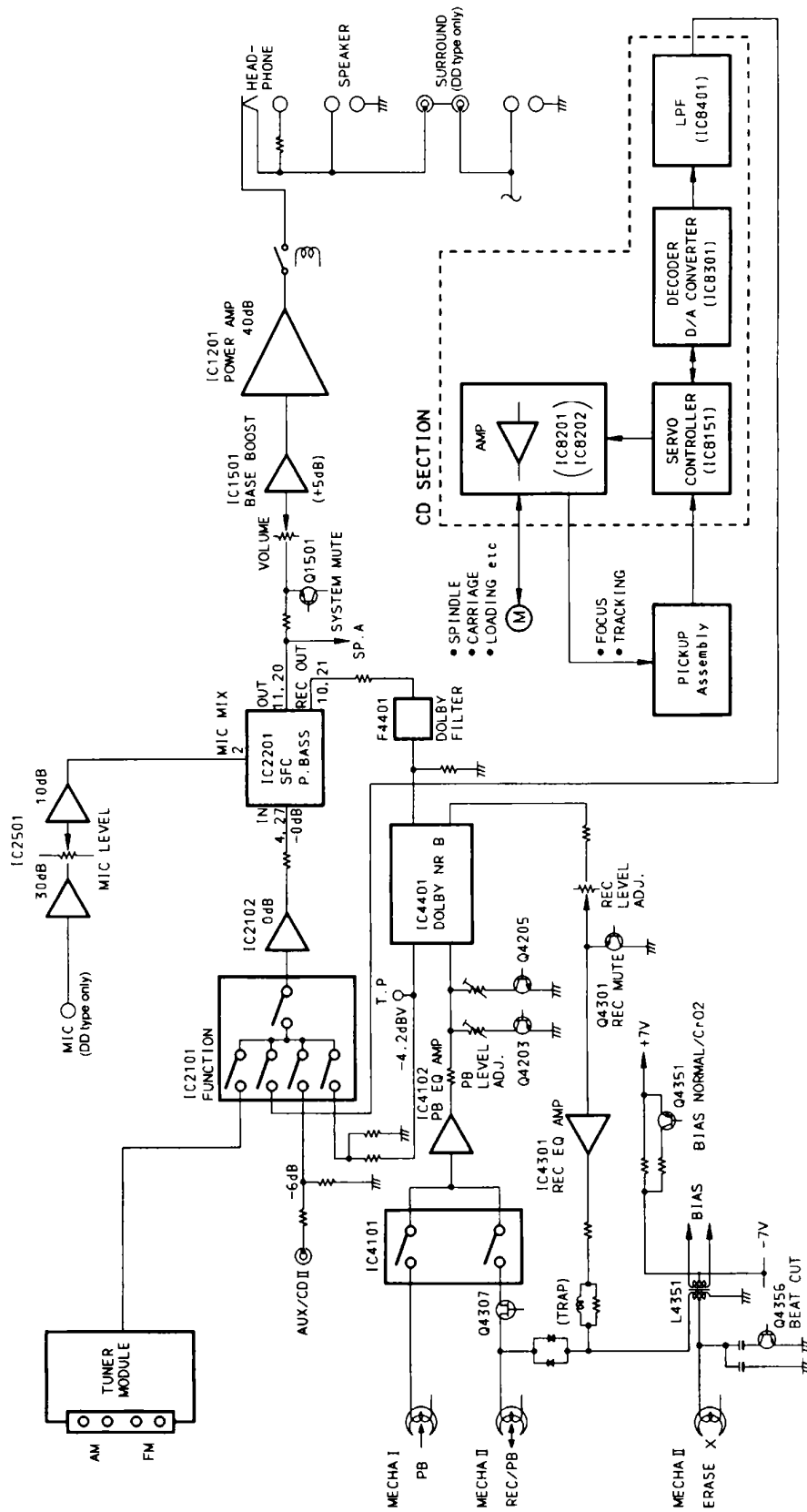

9. DISASSEMBLY

● CD DISC MANUAL REMOVAL METHOD

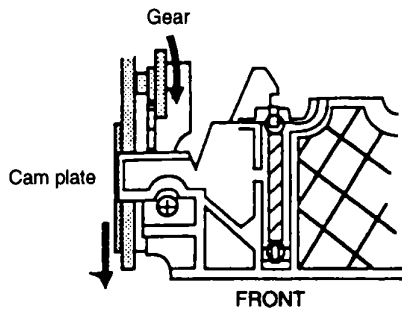

Turn the gear in arrow direction to the front, and move the cam plate to the front. When the gear is turned until the cam plate comes to the very front position (EJECT position), the CD disc will be pulled out.

● SERVOMECHANISM EXCHANGE METHOD AND MECHANISM ADJUSTMENT METHOD

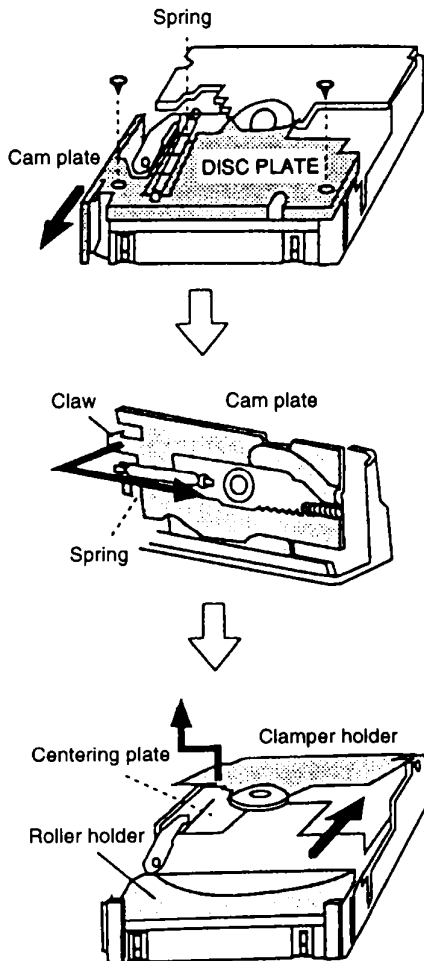

Remove the spring and the two screws, and then remove the disc plate. Move the cam plate to the very front position (EJECT position). (Refer to the CD disc manual removal method.)

Remove the spring. Remove to the front while pulling the claw part of the cam plate to the outside.

Raise the clamber holder lightly, slide it in arrow direction, and remove it. When the centering plate is moved to the rear, the four screws fixing the servomechanism become visible. When these screws are removed, the servomechanism assembly can be removed.

TAN and RAD adjustment are executed from above with the clamber holder and the roller holder removed and only the magnet clamber placed onto the CD disc.

10. PANEL FACILITIES

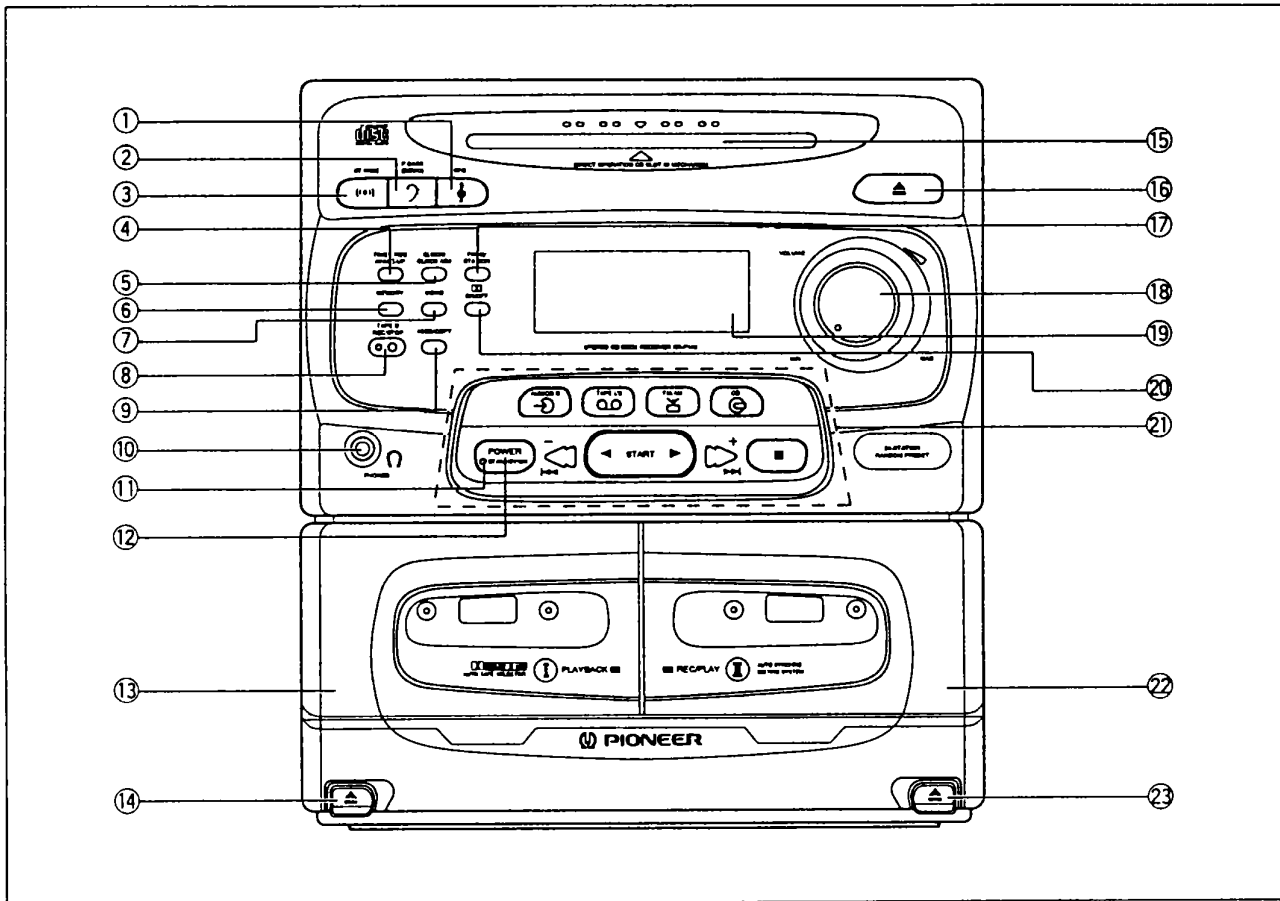

① SFC button

Each time this button is pressed, the mode changes in the following sequence:

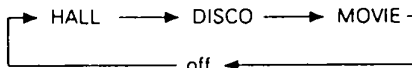

② P.BASS (DEMO) button

Each time this button is pressed, the mode changes in the following sequence:

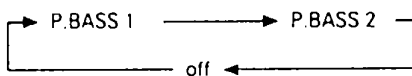

③ ST. WIDE button

Each time this button is pressed, the mode changes in the following sequence:

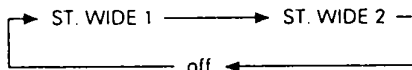

④ TIMER REC/WAKE-UP button

⑤ CLOCK/CLOCK ADJ button

⑥ MEMORY button

⑦ MONO button

⑧ Rec/Rec stop button

⑨ ASES/COPY button

⑩ Headphones jack

⑪ STANDBY indicator

This is the switch for electric power.

ON: When set to the ON position, power is supplied and the unit becomes operational.

STANDBY: When set to the STANDBY position, the main power flow is cut and the unit is no longer fully operational. A minute flow of power feeds the unit to maintain operation readiness. (The STANDBY indicator lights.)

⑫ POWER STANDBY/ON switch

⑬ TAPE I cassette door

⑭ TAPE I Eject button (▲)

XR-P160

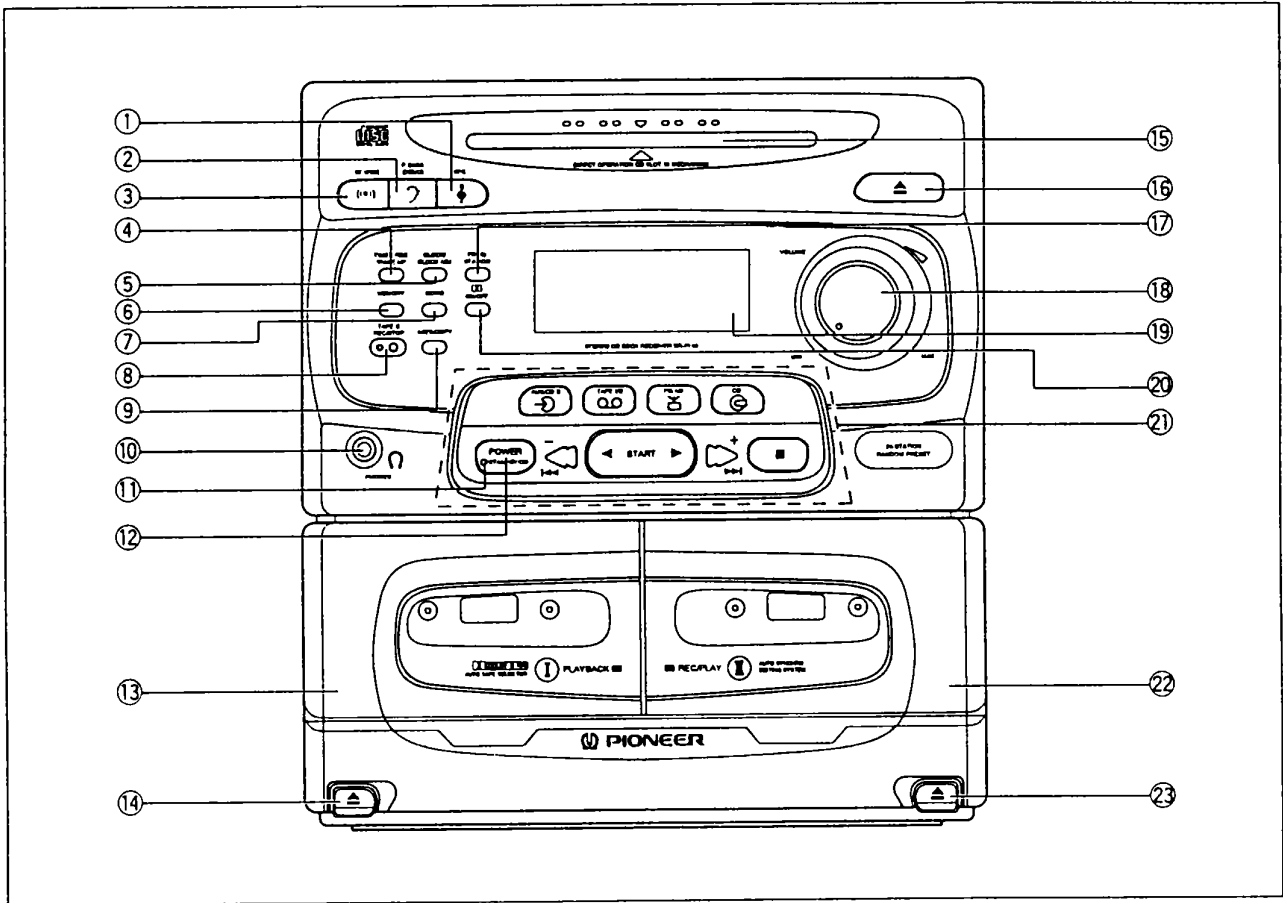

⑮ Disc slot

⑯ CD Eject button (▲)

⑰ FREQ/STATION button

Each time this button is pressed, the mode changes between FREQUENCY and STATION.

⑱ Volume control (VOLUME)

⑲ Display

⑳ (DOLBY*) NR ON/OFF button

Each time this button is pressed, DOLBY NR system turns ON and OFF.

㉑ Function buttons

㉒ TAPE II cassette door

㉓ TAPE II Eject button (▲)

- Dolby noise reduction manufactured under license from Dolby Laboratories Licensing Corporation.
- "DOLBY" and the double-D symbol are trademarks of Dolby Laboratories Licensing Corporation.

Function button section

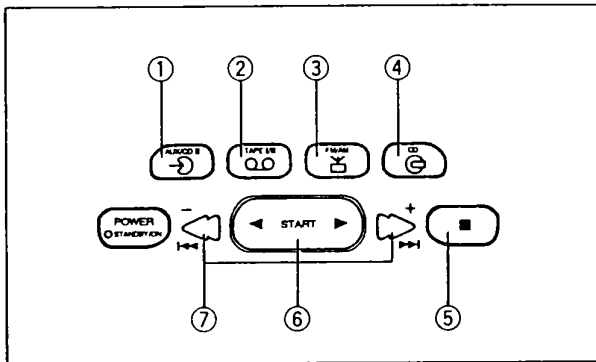

- ① AUX/CD II function button and indicator
- ② TAPE (I/II) function button and indicator
- ③ Tuner (FM/AM) function button and indicator
- ④ CD function button and indicator
- ⑤ STOP button (■)
- ⑥ START button (◀▶)
- ⑦ $\overleftarrow{\text{FF}}$, $\overrightarrow{\text{RR}}$ buttons

- Roles of the common operation buttons (The roles of the buttons vary depending on the input functions as shown below.)

During CD input

START: Play/pause button

STOP: Stop button

$\overrightarrow{\text{FF}}$: Fast forward/track search button

$\overleftarrow{\text{RR}}$: Fast reverse/track search button

During cassette deck input

START: Play button/Tape transport direction

STOP: Stop button

$\overrightarrow{\text{FF}}$: Fast forward button

$\overleftarrow{\text{RR}}$: Rewind button

During tuner operation

$\overrightarrow{\text{FF}}$: Frequency & Station + (up) button

$\overleftarrow{\text{RR}}$: Frequency & Station - (down) button

REMOTE CONTROL UNIT

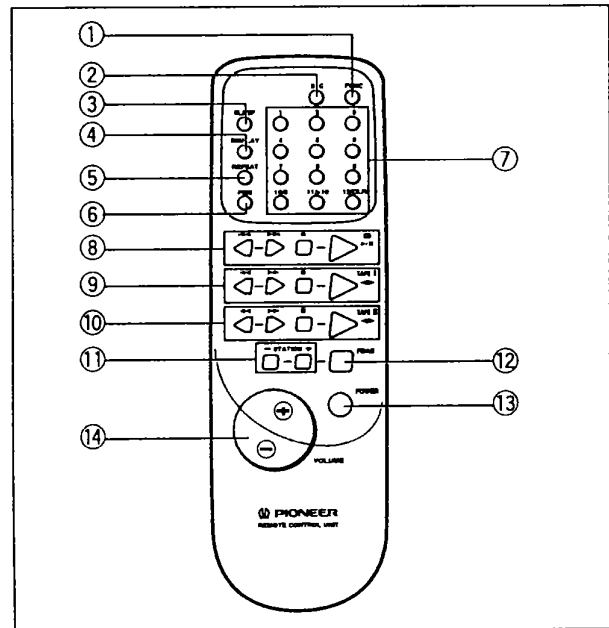

① Function button (FUNC)

Each time this button is pressed, the function changes in the following sequence:

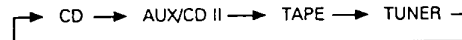

② SFC mode button

Each time this button is pressed, the function changes in the following sequence:

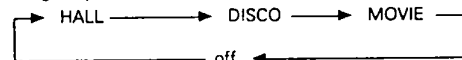

③ SLEEP timer button

④ DISPLAY button

⑤ REPEAT button

⑥ PGM button

⑦ Number buttons

These buttons are used for selecting track numbers of a CD and for scanning preset stations.

⑧ CD operation buttons

(Track search $\overleftarrow{\text{FF}}$ $\overrightarrow{\text{RR}}$, Stop ■, Play/Pause ▶/II)

⑨ TAPE I operation buttons

(Fast $\overleftarrow{\text{FF}}$ $\overrightarrow{\text{RR}}$, Stop ■, Play ◀▶)

⑩ TAPE II operation buttons

(Fast $\overleftarrow{\text{FF}}$ $\overrightarrow{\text{RR}}$, Stop ■, Play ◀▶)

⑪ STATION - (down), + (up) buttons

Before operation, memorize broadcast stations with the STATION -, + buttons.

+ ... Stations change in order in the upward direction.

- ... Stations change in order in the downward direction.

⑫ FM/AM band button

⑬ POWER button

⑭ VOLUME + (up), - (down) button

Increase/decrease the sound volume of the unit.

11. SPECIFICATIONS

STEREO CD CASSETTE DECK RECEIVER

Amplifier section

<XR-P160>

Continuous Power Output (RMS) 35 W + 35 W
(1 kHz, T.H.D. 10 % 6 Ω)

Continuous Power Output (DIN) 27 W + 27 W
(1 kHz, T.H.D. 1 % 6 Ω)

- Above specifications are for when power supply is 230 V.

FM/AM Tuner section

FM tuner section

Frequency Range 87.5 MHz to 108 MHz

Antenna input 75 Ω unbalanced

AM tuner section

Frequency Range

With 9 kHz step 531 kHz to 1,602 kHz

Antenna Loop antenna

CD section

Type Compact disc digital audio system

Wow and Flutter Limit of measurement
(± 0.001 % W.PEAK) or less (EIAJ)

Cassette deck section

Systems 4 track, 2-channel stereo

Heads Recording/playback head x 1

Playback head x 1

Erasing head x 1

Motor DC servo motor x 1

Tape type TYPE I (Normal)/TYPE II (HIGH/CrO₂) tape

Miscellaneous

Power Requirements AC 230 V, 50/60 Hz (U.K. model)

AC 220 - 230 V, 50/60 Hz (European model)

Power Consumption 187 W

Dimensions 240 (W) x 270 (H) x 297 (D) mm

Weight (without package) 5.5 kg

Accessories

Operating instructions 1

Remote control unit 1

AAA/R03 dry cell batteries 2

FM T-type antenna 1

AM loop antenna 1

NOTE:

Specifications and design subject to possible modification without notice, due to improvement.