

Service Manual



Portable Stereo CD System

MASH*
multi-stage noise shaping

COMPACT
disc
DIGITAL AUDIO

Radio Cassette
RX-ES50

Colour

(K) ... Black Type

Area

Suffix for Model No.	Area	Colour
(EB)	Great Britain	(K)
(EG)	Germany and Italy	
(GN)	Oceania	

* MASH is a trademark of NTT.

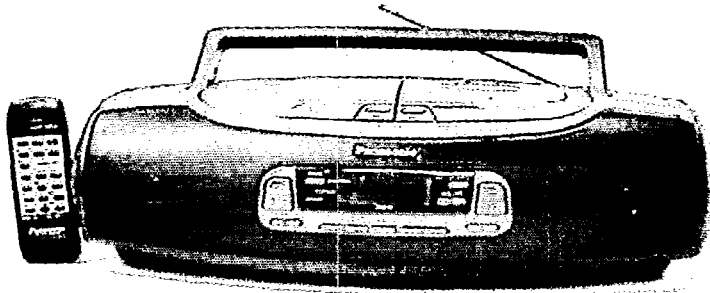

TAPE DECK : AR-2 MECHANISM SERIES
TRAVERSE DECK : RAE0150Z MECHANISM SERIES

■ Specifications

■ RADIO

Frequency range

FM	87.5 – 108MHz
LW	144 – 288kHz ... (EB,EG)
MW	522 – 1611kHz ... (EB,EG)
AM	531 – 1602kHz (9kHz step) ... (GN) 530 – 1600kHz (10kHz step) ... (GN)

Intermediate Frequency

FM	10.7MHz
AM	459kHz ... (EB,EG) 450kHz ... (GN)

Sensitivity

FM	17dB/50mW ... (EB,EG) 18dB/50mW ... (GN)
LW	54dB/m/50mW ... (EB,EG)
MW	53dB/m/50mW ... (EB,EG)
AM	49dB/m/50mW ... (GN)

■ CD PLAYER

Sampling frequency	44.1kHz
Decoding	16 bit linear
Beam source	Semiconductor laser (wavelength 780nm)
No. of channels	2 channels, stereo
Digital Filter	8 fs
Wow and flutter	Less than possible measurement data
D/A converter	MASH (1 bit DAC)

■ TAPE RECORDING

Track system	Stereo
Recording system	AC bias (100kHz)
Erasing system	AC
Monitor system	Variable sound monitor
Frequency range	
Normal	50 – 16000Hz
High	50 – 17000Hz

■ GENERAL

Power requirement	230 – 240V, 50Hz
Power consumption	36W
Battery	12V (Eight R20/LR20, UM-1 batteries)
Memory back-up for computer/clock	6V (Four R6/LR6, UM-3 batteries)
Speakers	2 Woofers; 2.7Ω
Jacks	
Input	MIX MIC; 5mV (3kΩ)
Output	PHONES; 32Ω
Dimensions (W x H x D)	499 x 162 x 262mm
Weight	3.8kg without batteries

Notes :

Specifications are subject to change without notice.
Weight and dimensions shown are approximate.

⚠ WARNING

This service information is designed for experienced repair technicians only and is not designed for use by the general public. It does not contain warnings or cautions to advise non-technical individuals of potential dangers in attempting to service a product. Products powered by electricity should be serviced or repaired only by experienced professional technicians. Any attempt to service or repair the product or products dealt with in this service information by anyone else could result in serious injury or death.

Panasonic®

© 1996 Matsushita Electronics (S) Pte Ltd
All rights reserved. Unauthorized copying
and distribution is a violation of law.

Self-Diagnostic Display Function

This unit is equipped with self-diagnosis display function. If a problem occurs, it will display an error code corresponding to the problem. Use this function when performing maintenance on the unit.

How to enter the Self-Diagnostic Function

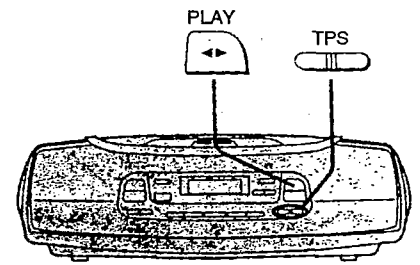
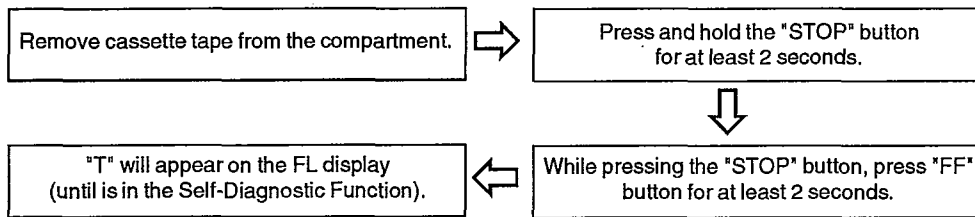

To display of Self-Diagnostic results

Error code for Self-Diagnosis are stored in memory during normal operation period. If there is any problem, the error code will be shown each time you press "STOP" button (while the unit is in the Self-Diagnostic Function mode).

Cassette Deck Test Procedure

Cassette Deck can be tested with the following procedures (H02, H03, F01, F02):

1. Set reverse mode to \rightleftarrows .
2. Set the self-diagnostic function mode.
3. Load the normal tape (recording prevention tab should be one side only).
4. Press "FF" and then "STOP".
5. Load the pre-recorded tape (recording prevention tab at both side).
6. Press "PLAY" and then "FF" to start TPS function.
7. Self-Diagnosis test will be completed when TPS is functioned.
* If TPS does not functioned properly, leave the tape till it stops automatically (Auto-Stop Function).
8. Press "STOP" button to show the error codes.

How to clear the Error Codes

- Press "POWER" button to OFF and then ON again to remove the error codes from FL (Display will change to normal indication).

Note: These error codes are still stored in memory and must be cleared when fault has been fixed as follow:

1. Remove batteries (for power and memory) and AC power supply.
2. Press and hold "POWER" button for at least 5 seconds.

Description of Error Code

Error code	Problem condition	Correction procedure
H01	Faulty operation of cassette mechanism. Example: Reverse-play operation performs when FWD button is pressed.	Faulty cassette mechanism mode switch [S971] and plunger. (Check and replace)
H02	Recording not possible, or recording mode entered even though erasure prevention tabs have been removed.	Faulty contact or short-circuit of erasure prevention switches [S974, S975]. (Check and replace)
H03	Playback not performed when Play ($\blacktriangleleft\blacktriangleright$) button is pressed. Motor turns when Play ($\blacktriangleleft\blacktriangleright$) button is pressed even though there is no tape cassette loaded in cassette holder.	Faulty contact or short-circuit of cassette half detect switch. [S972] (Check and replace)
H06	CrO ₂ setting cannot be made.	Faulty CrO ₂ detection switch. [S973] (Check and replace)
F01	When the Play ($\blacktriangleleft\blacktriangleright$) button is pressed, the tape advances slightly and then stops.	Faulty reel pulse, faulty hole detect IC. [IC971] (Check and replace)
F02	Cassette deck will not perform TPS function.	Faulty playback /recording pre-amplifier IC or low pass filter IC. [IC302, IC303] (Check and replace)
F15	Relatively long time (about 8 seconds) is required to begin play when the CD Play/Pause ($\blacktriangleright/\blacksquare$) button is pressed from the power-off state or from a function other than CD player.	Faulty contact on CD mechanism optical pick-up rest switch [S701]. (Check and replace)
F26	CD does not function even when pressing CD Play/Pause ($\blacktriangleright/\blacksquare$) button. CD track jumps. CD rotates irregularly.	Faulty system contact (IC602) or servo processor (IC702). (Check and replace) Faulty connection or broken of FPC for CD circuit. (Check and replace)
F75	"NO DISC" indication show in the FL display even CD is loaded.	Faulty power circuit of CD (IC604 or circuit for power supply) (Check and replace) Faulty servo processor IC (IC702). (Check and replace)
U01	When the unit is operating on batteries, power supply ceases soon after the POWER button is set to ON.	It is due to consumption of batteries. Replace the batteries with new ones.
U02	Settling the POWER button to ON causes no supply of power.	Check the power plug (AC), or insert batteries (DC).

■ Measurements and Adjustments

■ ALIGNMENT INSTRUCTIONS

READ CAREFULLY BEFORE ATTEMPTING ALIGNMENT

1. Set volume level to maximum.
2. Set preset EQ. to OFF.
3. Set power source voltage to 12V DC.

4. Output of signal generator should be no higher than necessary to obtain an output reading.

< TUNER SECTION > ... (GN)

■ AM-IF ALIGNMENT

SIGNAL GENERATOR or SWEEP GENERATOR		RADIO DIAL SETTING	INDICATOR (ELECTRONIC VOLTMETER or OSCILLOSCOPE)	ADJUSTMENT (Shown in Fig. 1)	REMARKS
CONNECTIONS	FREQUENCY				
Fashion a loop of several turns of wire and radiate a signal into the loop ant. of receiver.	450 kHz 30% Mod. at 400Hz	Point of non-interference. (on/about 600Hz)	Headphones Jack (32Ω) Fabricate the plug as shown in Fig. 2 and then connect the lead wires of the plug to the measuring instrument.	T1 (AM IFT)	Adjust for maximum output.

■ AM-RF ALIGNMENT

SIGNAL GENERATOR or SWEEP GENERATOR		RADIO DIAL SETTING	INDICATOR (ELECTRONIC VOLTMETER or OSCILLOSCOPE)	ADJUSTMENT (Shown in Fig. 1)	REMARKS
CONNECTIONS	FREQUENCY				
Fashion a loop of several turns of wire and radiate a signal into the loop ant. of receiver.	594kHz	Tune to signal	TP7 ...(+) TP5 ...(-)	(*1) L3(AM ANT Coil)	Adjust for maximum output. Adjust L3 by moving coil along the ferrite core.
"	1,503kHz	"	"	CT1 (AM ANT Trimmer)	Adjust for maximum output.

(*1) Fix antenna coil with wax after completing alignment.

< TUNER SECTION > ... (EB,EG)

■ AM-IF ALIGNMENT

SIGNAL GENERATOR or SWEEP GENERATOR		RADIO DIAL SETTING	INDICATOR (ELECTRONIC VOLTMETER or OSCILLOSCOPE)	ADJUSTMENT (Shown in Fig. 1)	REMARKS
CONNECTIONS	FREQUENCY				
Fashion a loop of several turns of wire and radiate a signal into the loop ant. of receiver.	459 kHz 30% Mod. at 400Hz	Point of non-interference. (on/about 600Hz)	Headphones Jack (32Ω) Fabricate the plug as shown in Fig. 2 and then connect the lead wires of the plug to the measuring instrument.	T1 (AM IFT)	Adjust for maximum output.

■ LW-RF ALIGNMENT

Fashion a loop of several turns of wire and radiate a signal into the loop ant. of receiver.	153kHz	Tune to signal	TP7 ...(+) TP5 ...(-)	(*2) L3-1(LW ANT Coil)	Adjust for maximum output. Adjust L3-1 by moving coil along the ferrite core.
"	270kHz	"	"	CT2 (LW ANT Trimmer)	Adjust for maximum output.

(*2) Fix antenna coil with wax after completing alignment.

■ MW-RF ALIGNMENT

Fashion a loop of several turns of wire and radiate a signal into the loop ant. of receiver.	594kHz	Tune to signal	TP7 ...(+) TP5 ...(-)	(*3) L3-2(MW ANT Coil)	Adjust for maximum output. Adjust L3-2 by moving coil along the ferrite core.
"	1503kHz	"	"	CT1(MW ANT Trimmer)	Adjust for maximum output.
(*3) Cement antenna coil with wax after completing alignment.					

< CASSETTE DECK SECTION >

■ TAPE SPEED ADJUSTMENT

TEST TAPE	EQUIPMENT CONNECTION ELECTRONIC COUNTER	ADJUSTMENT (Shown in Fig. 5)	SPECIFICATION	REMARKS
QZZCWAT (3 kHz)	Headphones Jack (32Ω) Fabricate the plug as shown in Fig. 2 and then connect the lead wires of the plug to the measuring instrument.	Motor VR	3000 ± 30Hz	Playback mode

■ HEAD AZIMUTH ALIGNMENT

TEST TAPE	EQUIPMENT CONNECTION ELECTRONIC COUNTER	ADJUSTMENT (Shown in Fig. 3)	SPECIFICATION	REMARKS
QZZCAB (8kHz, -20dB)	Headphones Jack (32Ω) Fabricate the plug as shown in Fig. 2 and then connect the lead wires of the plug to the measuring instrument.	Azimuth screw	Maximum output	Playback mode

■ RECORD BIAS VOLTAGE & FREQUENCY CHECK

TEST TAPE	EQUIPMENT CONNECTION ELECTRONIC COUNTER (refer to Fig. 4)	ADJUSTMENT	SPECIFICATION	REMARKS
Use Normal tape	TP6 ...(+) TP4 ...(-)	—	16 ± 3mV	• Record mode
Use Normal tape	TP6 ...(+) TP4 ...(-)	—	100 ± 10kHz ... (GN) 95 ± 10kHz ... (EB,EG)	1. Set to Record mode 2. Confirm sine-wave appears without distortion/abnormal oscillation.

■ BEATPROOF (II - I) CHECK

TEST TAPE	EQUIPMENT CONNECTION ELECTRONIC COUNTER (refer to Fig. 4)	ADJUSTMENT	SPECIFICATION	REMARKS
Use Normal tape	TP6 ...(+) TP4 ...(-)	—	Frequency Shift from B.P. II - I (4.5 ± 1kHz)	1. Set the function selector to Tuner position. 2. Set to B.P. II 3. Confirm oscillating waveform to be sinusoidal without distortion/abnormal oscillation.

BEATPROOF (III – II) CHECK ... (for EB and EG only)

TEST TAPE	EQUIPMENT CONNECTION ELECTRONIC COUNTER (refer to Fig. 4)	ADJUSTMENT	SPECIFICATION	REMARKS
Use Normal tape	TP6 ...(+) TP4 ...(-)	—	Frequency Shift from B.P. III — II ($2.5 \pm 1\text{kHz}$)	1. Set the function selector to Tuner position. 2. Set to B.P. III 3. Confirm oscillating waveform to be sinusoidal without distortion/abnormal oscillation.

ALIGNMENT POINT

• Please refer to Circuit Board and Wiring Connection Diagram for test point locations.

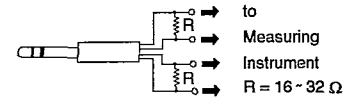
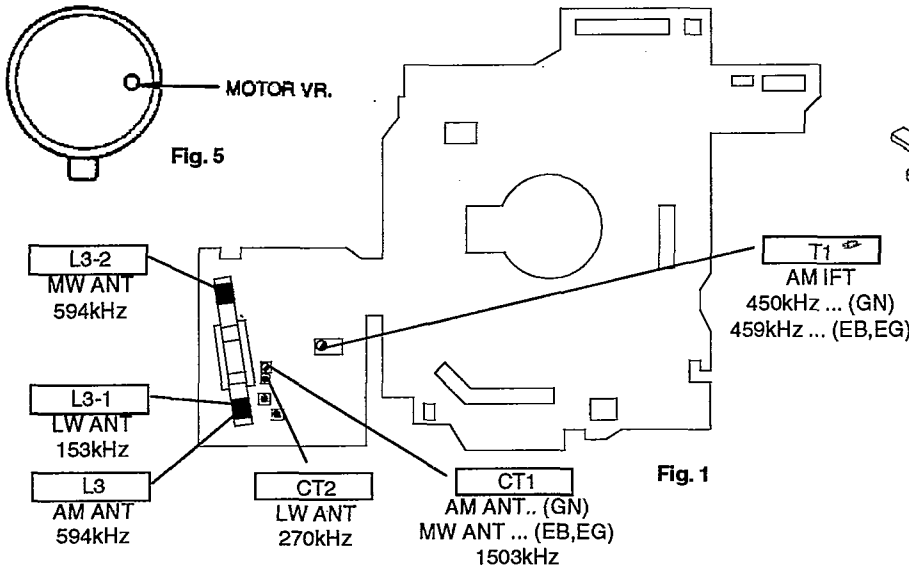

Fig. 2

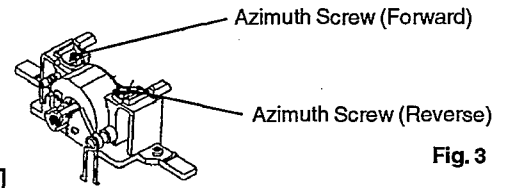

Fig. 3

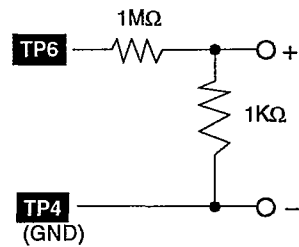

Fig. 4

Terminal Function of ICs

• IC701 (AN8835SBE1) Servo Amplifier

Pin No.	Mark	I/O	Function
1	PDA	I	PD signal input
2	PDB	I	PD signal input
3	VCC	I	Power supply connection
4	LPD	I	Laser PD connection
5	LD	O	Power out for LD driving
6	RF	O	RF signal output
7	RFIN	I	RF signal input
8	CAGC	I	AGC loop filter connection
9	ARF	O	RF-AGC output
10	CSBRT	I	Capacitor for detection connection
11	CEA	I	Capacitor connection for HPF amplifier
12	BDO	O	BDO output ("H" : drop out)
13	LDON	I	LD APC input ("H" : ON, "L" : OFF)
14	GND	—	Ground connection

Pin No.	Mark	I/O	Function
15	/RFDET	O	NRFDET output ("L" : detection)
16	CROSS	O	CROSS output (Track cross signal output)
17	OFTR	O	Off-track output("L" : ON track, "H" : OFF track)
18	VDET	O	VDET output("H" : Vibration detected)
19	ENV	O	RF envelope detection
20	TEBPF	I	Vibration detection signal input
21	CCRS	I	Capacitor for LPF connection
22	TE	O	Tracking error signal output
23	FE	O	Focus error signal output
24	TBAL	I	Tracking balance signal input
25	FBAL	I	Focus balance signal input
26	VREF	O	Reference voltage output
27	PDE	I	PD signal input
28	PDF	I	PD signal input

• IC702 (MN662741RPA) Servo processor / Digital signal processor / Digital filter / D/A converter

Pin No.	Mark	I/O	Function
1	BCLK	O	Serial bit clock terminal (Not used, open)
2	LRCK	O	L/R discriminating signal (Not used, open)
3	SRDATA	O	Serial data (Not used, open)
4	DVDD1	I	Power supply (digital circuit) terminal
5	DVSS1	—	GND (digital circuit) terminal
6	TX	O	Digital audio interface signal
7	MCLK	I	Microprocessor command clock signal
8	MDATA	I	Microprocessor command data signal
9	MLD	I	Microprocessor command load signal
10	SENSE	O	Sense signal output (OFT,FESL,MAGEND,NAJEND,POSAD,SFG)
11	/FLOCK	O	Optical servo condition(focus)("L" : lead-in)
12	/TLOCK	O	Optical servo condition(tracking)("L" : lead-in)
13	BLKCK	O	Sub-code block clock (f=75Hz)
14	SQCK	I	External clock signal input for sub-code Q register.
15	SUBQ	O	Sub-code Q code output
16	DMUTE	I	Muting input ("H" : mute)
17	STAT	O	Status signal output (CRC,CUE,CLVS,TTSTVP,FCLV,SQCK)
18	/RST	I	Reset input
19	SMCK	O	1/2-divided clock signal of crystal oscillating at MSEL="H" (fSMCK=8.4672MHz) 1/4-divided clock signal of crystal oscillating at MSEL="L" (fSMCK=4.2336MHz)
20	PMCK	O	1/192-divided clock signal of crystal oscillating (fPMCK=88.2kHz) (Not used, open)
21	TRV	O	Traverse servo control output
22	TVD	O	Traverse drive signal output
23	PC	O	Spindle motor ON signal output ("L" : ON)
24	ECM	O	Spindle motor drive signal output (forced mode output)
25	ECS	O	Spindle motor drive signal output (servo error signal output)
26	KICK	O	Kick pulse output
27	TRD	O	Tracking drive output
28	FOD	O	Focus drive output
29	VREF	I	D/A (drive) output (TVD,ECS,TRD,FOD, FBAL, TBAL) Reference voltage input.
30	FBAL	O	Focus balance adjustment output (Not used, open)
31	TBAL	O	Tracking balance adjustment output
32	FE	I	Focus error signal input (analog input)
33	TE	I	Tracking error signal input (analog input)
34	RFENV	I	RF envelope signal input
35	VDET	I	Vibration detection signal input ("H" : detection)

Pin No.	Mark	I/O	Function
36	OFT	I	Off-track signal input ("H" : off track)
37	TRCRS	I	Track cross signal input
38	/RFDET	I	RF detection signal input ("L" : detection)
39	BDO	I	Dropout signal input ("H" : Dropout)
40	LDON	O	Laser on signal output ("H" : ON)
41	TES	O	Tracking error shunt signal output ("H" : shunt)
42	PLAY	O	Play signal out ("H" : PLAY)
43	WVEL	O	Double speed status signal output ("H" : DS)
44	ARF	I	RF signal input
45	IREF	I	Reference current input
46	DRF	I	DSL bias (Not used, open)
47	DSLFL	I/O	DSL loop filter
48	PLLFL	I/O	PLL loop filter
49	VCOFL	I/O	VCO loop filter (Not used, open)
50	AVDD2	I	Power supply input (for analog circuit)
51	AVSS2	—	GND (for analog circuit)
52	EFM	O	EFM signal output (Not used, open)
53	PCK	O	PLL extraction clock output (Not used, open) (fPCK=4.321 MHz during normal playback)
54	PDO	O	Phase comparison signal of EFM and PCK signals (Not used, open)
55	SUBC	O	Sub-code serial data output (Not used, open)
56	SBCK	I	Sub-code frame clock signal output (fCLDCK=7.35kHz during normal playback)
57	VSS	—	GND
58	X1	I	Crystal oscillating circuit input (f=16.9344MHz)
59	X2	O	Crystal oscillating circuit output (f=16.9344MHz)
60	VDD	I	Power supply input (for oscillating circuit)
61	BYTCK	O	Byte clock output (Not used, open)
62	/CLDCK	O	Clock input for sub-code serial data (Not used, open)
63	FCLK	O	Crystal frame clock signal output (fCLK=7.35kHz, double=14.7kHz)
64	PFLAG	O	Interpolation flag output ("H" : interpolation) (Not used, open)
65	FLAG	O	Flag output (Not used, open)
66	CLVS	O	Spindle servo phase synchronizing signal output ("H" : CLV, "L" : rough servo) (Not used, open)
67	CRC	O	Sub-code CRC checked output ("H" : OK, "L" : NG) (Not used, open)
68	DEMPH	O	De-emphasis ON signal output ("H" : ON) (Not used, open)
69	RESY	O	Frame resynchronizing signal output (Not used, open)
70	/RST2	I	Reset input through MASH circuit ("L" : Reset)
71	/TEST	I	Test input

Pin No.	Mark	I/O	Function
72	AVDD1	I	Power supply input (for analog circuit)
73	OUTL	O	Left channel audio signal output
74	AVSS1	—	GND
75	OUTR	O	Right channel audio signal output
76	RSEL	I	RF signal polarity assignment input (at "H" level, RSEL="H", at "L" level, RSEL="L")
77	CSEL	I	Crystal oscillating frequency designation input

Pin No.	Mark	I/O	Function
			"L" : 16.9344MHz "H" : 33.8688MHz
78	PSEL	I	Test input (normally "L") (Not used, open)
79	MSEL	I	Output mode switching of SUBQ terminal ("H" : Q code buffer mode)
80	SSEL	I	Output frequency switching for SMCK terminal "H" : SMCK=8.4672MHz "L" : MCK=4.2336MHz (Not used, open)

• IC602 (MND3256REBE2) System Microprocessor

Pin No.	Mark	I/O	Function
1	VDD	I	+5V power input
2	OSC2	O	6.0MHz ceramic oscillator output
3	OSC1	I	6.0MHz ceramic oscillator input
4	VSS	—	GND
5	XI	I	32kHz x'tal oscillator input
6	XO	O	32kHz x'tal oscillator output
7	VREF-	—	AD convertor reference voltage (GND)
8	ADIN7	I	AD input 7 (REC INH, HALF, MODE)
9	ADING	I	AD input 7 (REEL, PULSE, TPS)
10	MBPF2	O	μ-com beat proof select output 2
11	MBPF1	O	μ-com beat proof select output 1
12	PWRDET	I	Power circuit output detection
13	VCCDET	I	Power detection input
14	ADINI	I	Operation key input
15	ADINO	I	Operation key input
16	VREF+	I	AD convertor reference voltage (VDD)
17	REM STBY	I	Power on input for remote control receiver
18	CDCLSW	I	CD lid closed detection SW (L : closed)
19	MCLK	O	Data output for CD signal processor IC
20	PWM	O	PWM output for volume control
21	MDATA	O	Data output for CD signal processor IC
22	MLD	O	Strobe output for CD signal processor IC
23	BC1	O	Bus control output 1 (use as 3 state)
24	BC2	O	Bus control output 2 (use as 3 state)
25	BC3	O	Bus control output 3 (use as 3 state)
26	BC4	O	Bus control output 4 (use as 3 state)
27	TC1	O	Treble control output 1 (use as 3 state)
28	TC2	O	Treble control output 2 (use as 3 state)
29	TC3	O	Treble control output 3 (use as 3 state)
30	TC4	O	Treble control output 4 (use as 3 state)
31	REMOCON IN	I	Remote control receiver pulse input
32	BLKCK	I	Sub-code block clock input
33	SENSE	I	CD SENSE input
34	FLOCK	I	CD focus lock signal (L : lock)
35	/RESET	I	+5V power input

Pin No.	Mark	I/O	Function
36	TLOCK	I	CD tracking lock signal (L : lock)
37	CD RESET	O	CD reset output
38	FUNC CD	O	Function control output (CD : L)
39	SQCK	O	Clock input for CD sub-code
40	SUBQ	I	CD sub-code data input
41	NC	—	not used
42	SYNC	O	Divided clock pulse output
43	GND	I	Mode setting input for 1-chip μ-com (L : 1-chip)
44	PWRCNT	O	Power control output (H : power on)
45	MUTE A	O	Audio muting output (H : mute on)
46	/DMT	O	Mechanism muting output
47	REC H	O	Recording select output (H : REC)
48	BP3H	O	AM recording beat proof control output
49	BP2H	O	AM recording beat proof control output
50	PL	O	Mechanism plunger drive signal (H : on)
51	MOTOR	O	Mechanism motor drive signal (H : on)
52	TPS	I	TPS signal input (L : music exist) 50
53	CRO2	I	Tape type detection (H : CrO2)
54	DES1	I	Area selection input 1
55	DES2	I	Area selection input 2
56	DES3	I	Area selection input 3
57	STATUS	I	CD STATUS input
58	RESTSW	I	CD reset position detection input (H : reset position)
59	TUNED	I	Tuner reception condition input (L : Tuned)
60	T MUTE	O	Tuner muting output (H : on, Hi-z : off)
61	PLL DI	O	Tuner PLL data output
62	PLL CL	O	Tuner PLL clock output
63	PLL CE	O	Tuner PLL strobe output
64-68	NC	—	Not used
69-93	SEG 24 ~ 0	O	LCD segment signal output (24~0)
94-97	COM 3 ~ 0	O	LCD common output (3 ~ 0)
98	VLC 3	I	LCD bias reference voltage input 3
99	VLC 2	I	LCD bias reference voltage input 2
100	VLC 1	I	LCD bias reference voltage input 1

• IC703 (AN8389SE1) Focus coil / Tracking coil / Traverse motor / Spindle motor driver

Pin No.	Mark	I/O	Function
1	VCC	I	Power supply terminal
2	VREF	I	Reference voltage input
3	IN4	I	Motor driver (4) input
4	IN3	I	Motor driver (3) input
5	GND	—	Ground connection
6	NC	—	Not used
7	NRESET	I	Reset input
8	GND	—	Ground connection
9	IN2	I	Motor driver (2) input
10	PC2	I	PC2 (power cut) input
11	IN1	I	Motor driver (1) input
12	PC1	I	PC1 (power cut) input (Not used, open)

Pin No.	Mark	I/O	Function
13	PVCC1	I	Power supply (1) for driver
14	PGND1	—	Ground connection (1) for driver
15	D1-	O	Motor driver (1) reverse-action output
16	D1+	O	Motor driver (1) forward-action output
17	D2-	O	Motor driver (2) reverse-action output
18	D2+	O	Motor driver (2) forward-action output
19	D3-	O	Motor driver (3) reverse-action output
20	D3+	O	Motor driver (3) forward-action output
21	D4-	O	Motor driver (4) reverse-action output
22	D4+	O	Motor driver (4) forward-action output
23	PGND2	—	Ground connection (2) for driver
24	PVCC2	I	Power supply (2) for driver

■ Terminal Guide of ICs, Transistors and Diodes

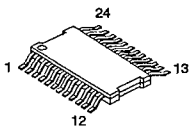
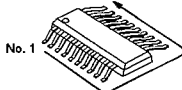
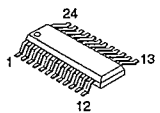
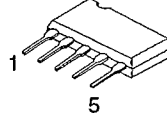
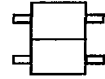
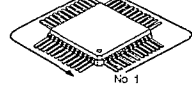
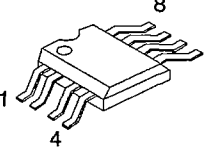
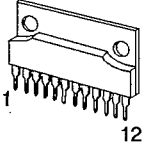
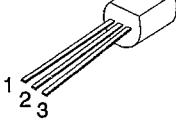
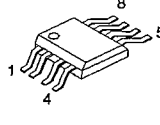
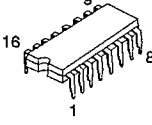
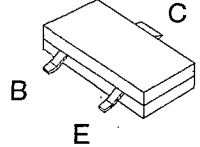
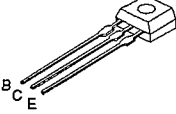
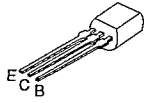
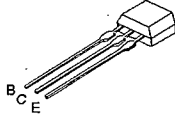
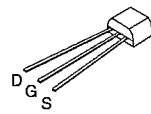
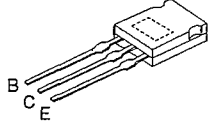
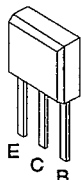
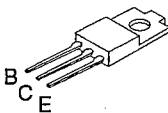
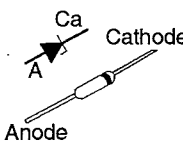
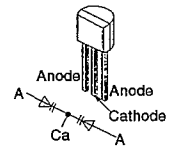
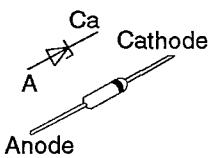
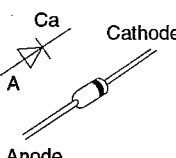
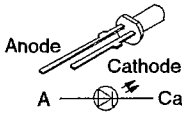
<p>AN8389SE1</p> 	<p>AN8835SBE1 (28P) BU2616F-E2 (18P)</p> 	<p>BH3852FSE2 LA1832MS-TEL</p> 	<p>BA7755A</p> 	<p>ON2180RLC</p> 	<p>MND3256REBE2 (100P) MN662741RPA (80P)</p> 
<p>BA4558FE2</p> 	<p>AN7135</p> 	<p>PST600HTA S81350HG-T</p> 	<p>TA7358FMATEL KV1583BMTL</p> 	<p>TA8142AP</p> 	<p>2SB709S</p> 
<p>2SC2785FTA 2SC2786LTA 2SD1020HTA</p> 	<p>2SC3313BTA BA1A4PTA BA1L3MTA BA1L3NTA BA1L3ZTA BN1A4PTA BN1L3NTA BN1L3ZTA</p>	<p>2SD965RTA 2SC1845FTA 2SD467CTZ</p> 	<p>2SC1740SLNRT 2SC829BTA</p> 	<p>2SJ40CDTA</p> 	<p>2SB1357ETA</p> 
	<p>2SA1175FTA 2SB1030RTA BA1A4MTA BA1L4MTA BN1A4MTA</p>	<p>2SB1566E</p> 		<p>RVDMTZ9R1BTA HZS6A3TD HZS5B3TD HZS9B2TD HZS11C3TD</p>	<p>KV1360NT KV1520NT</p> 
	<p>MTZJ5R6BTA RVDMTZ12BTA MTZJ12BTA MTZJ9R1BTA</p>		<p>1SR35200TB 1SS254TA MA165TA RB441QT77 RVD1SS135TA</p>	<p>BR5385XJ220K</p> 	

A SERVO CIRCUIT

OPTICAL PICKUP

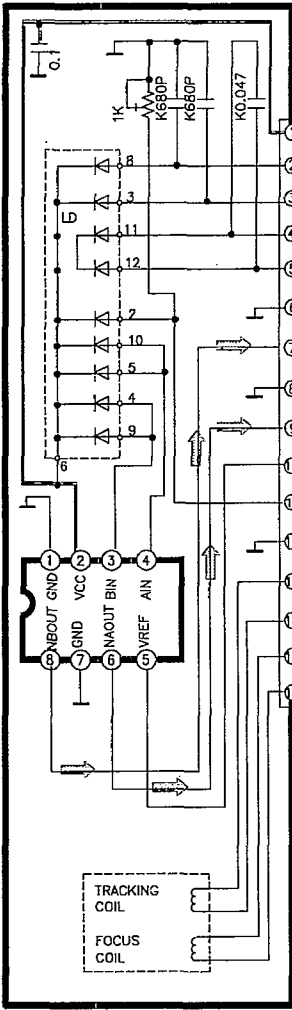

Q701
2SB709S
LASER POWER
DRIVE

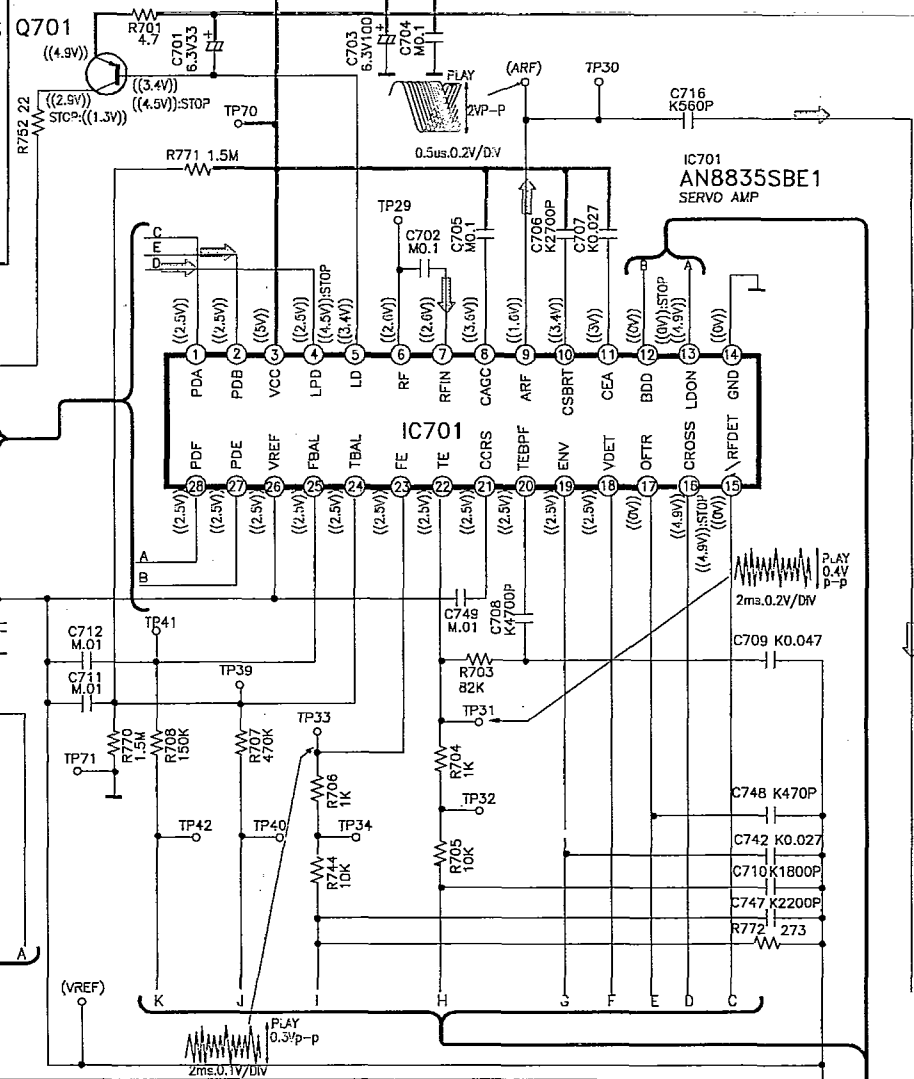

M702
SPINDLE
MOTOR

M701
TRAVERSE
MOTOR

IC703
AN8389SE1
FOCUS COIL / TRACKING COIL /
TRAVERSE MOTOR /
SPINDLE MOTOR DRIVE

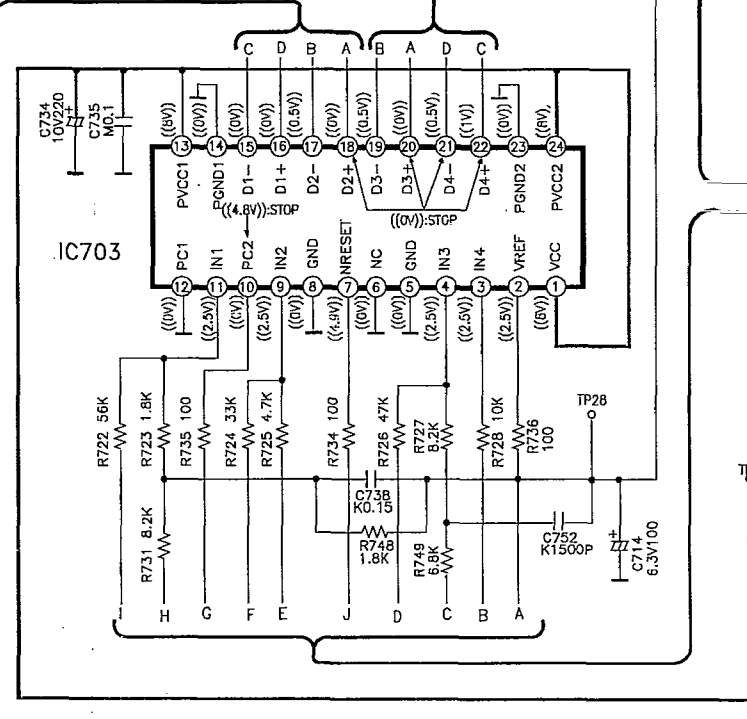

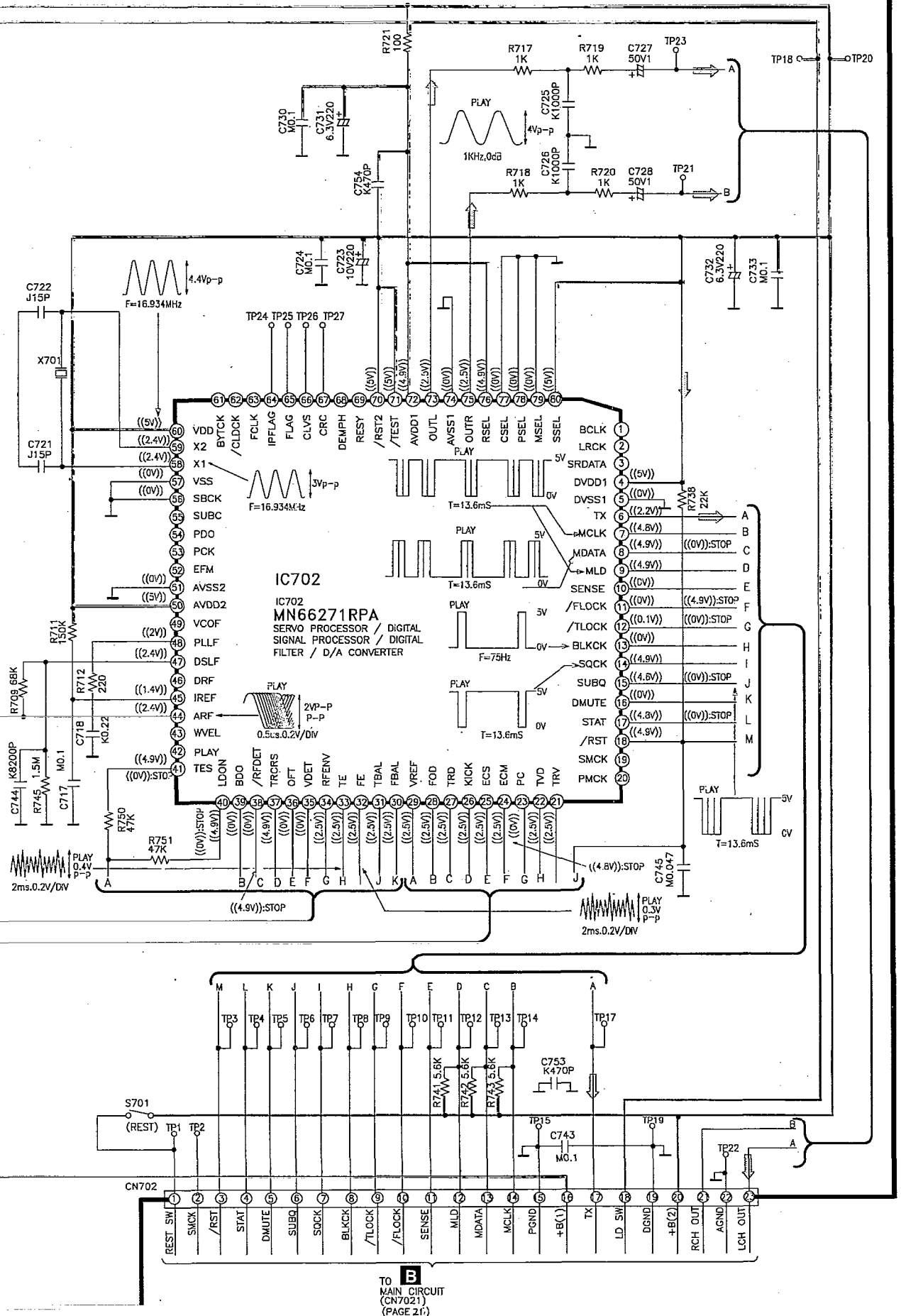

B MAIN CIRCUIT

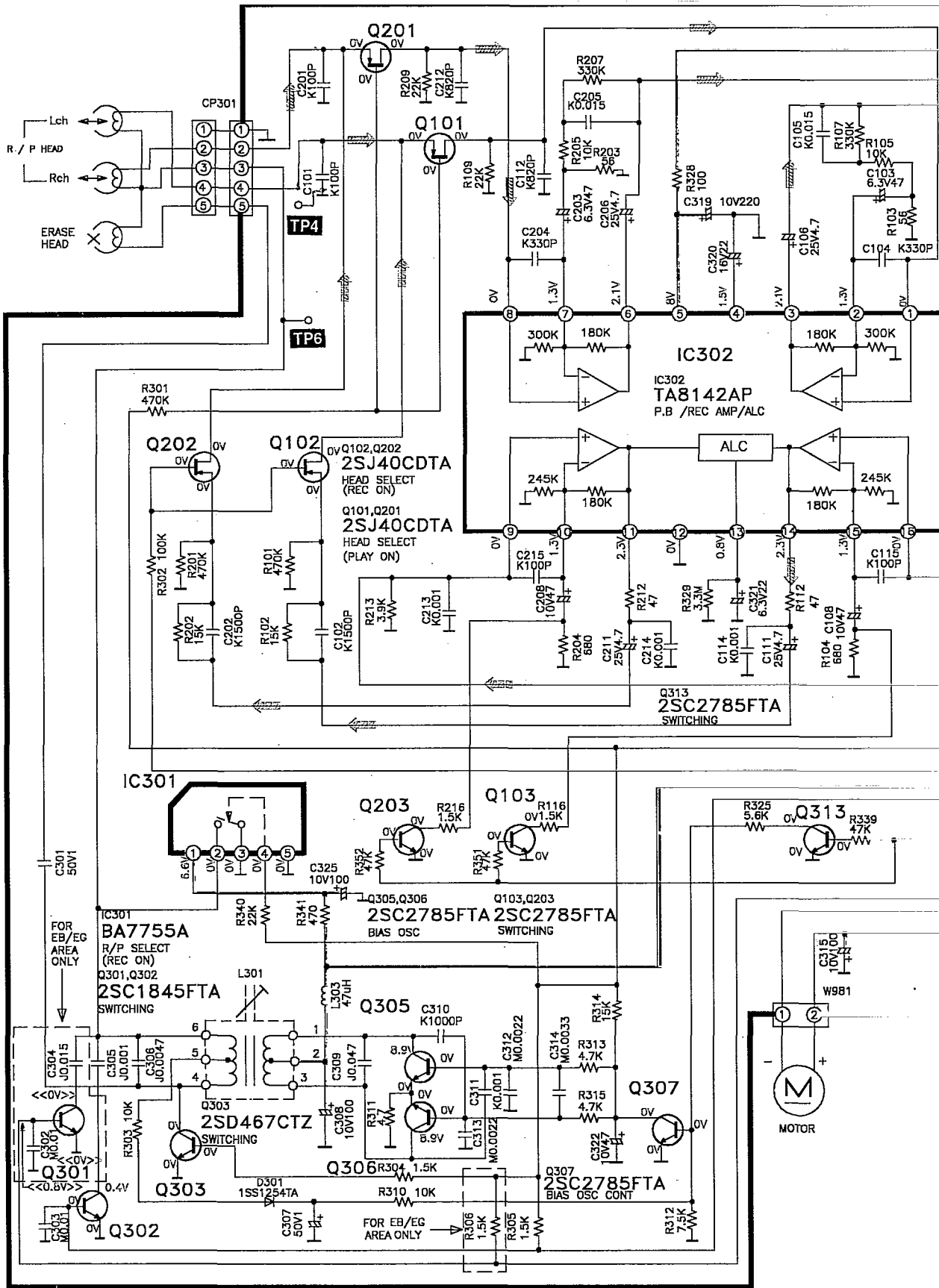

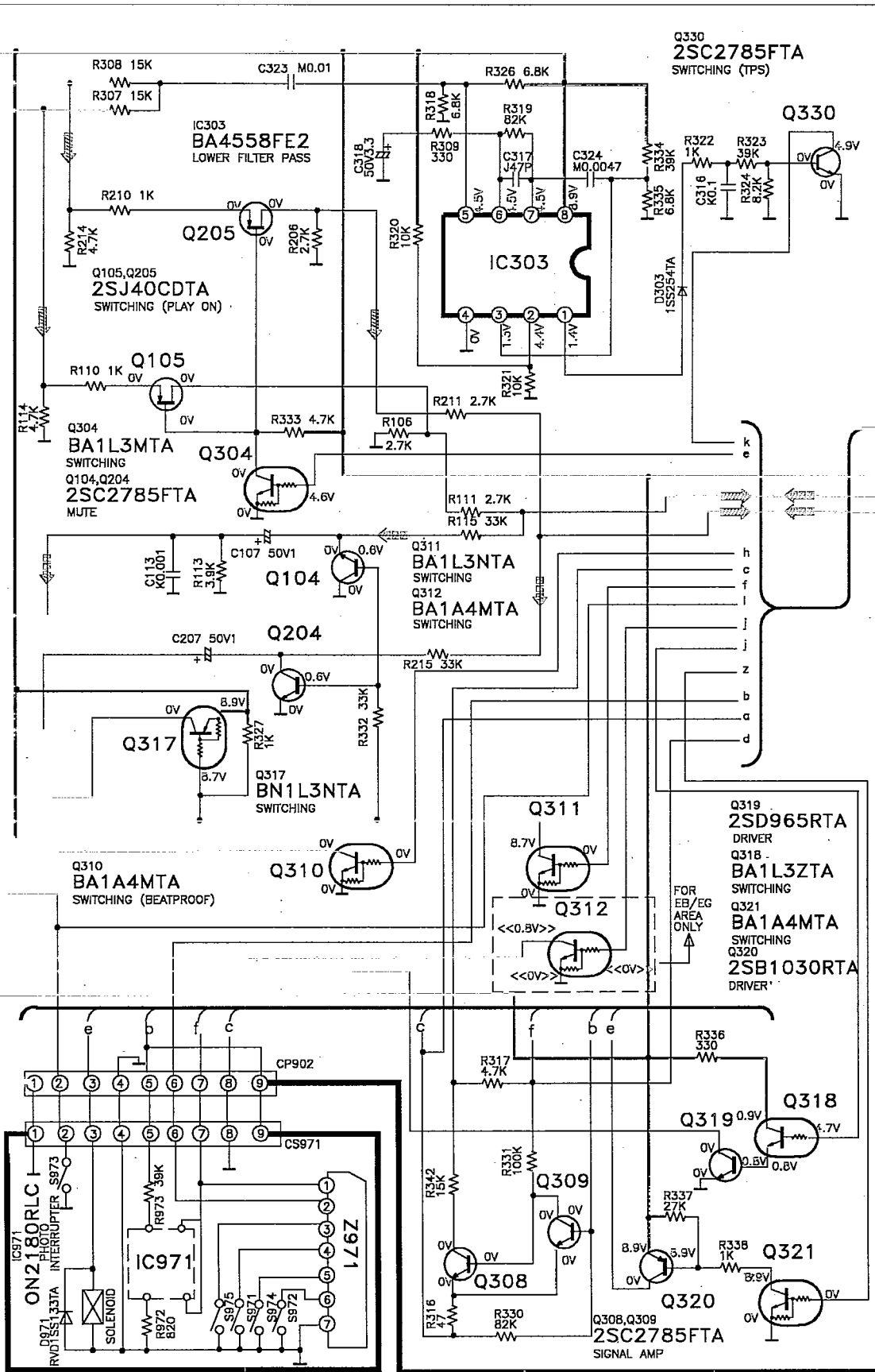

F MECHANISM CONTROL CIRCUIT

D CASSETTE EJECT CIRCUIT

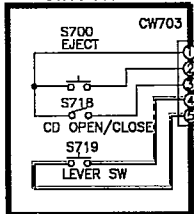

C PANEL CIRCUIT

RCH
PM DYNAMIC
SPEAKER
8cm, 2.2 Ω

LCH
PM DYNAMIC
SPEAKER
8cm, 2.2 Ω

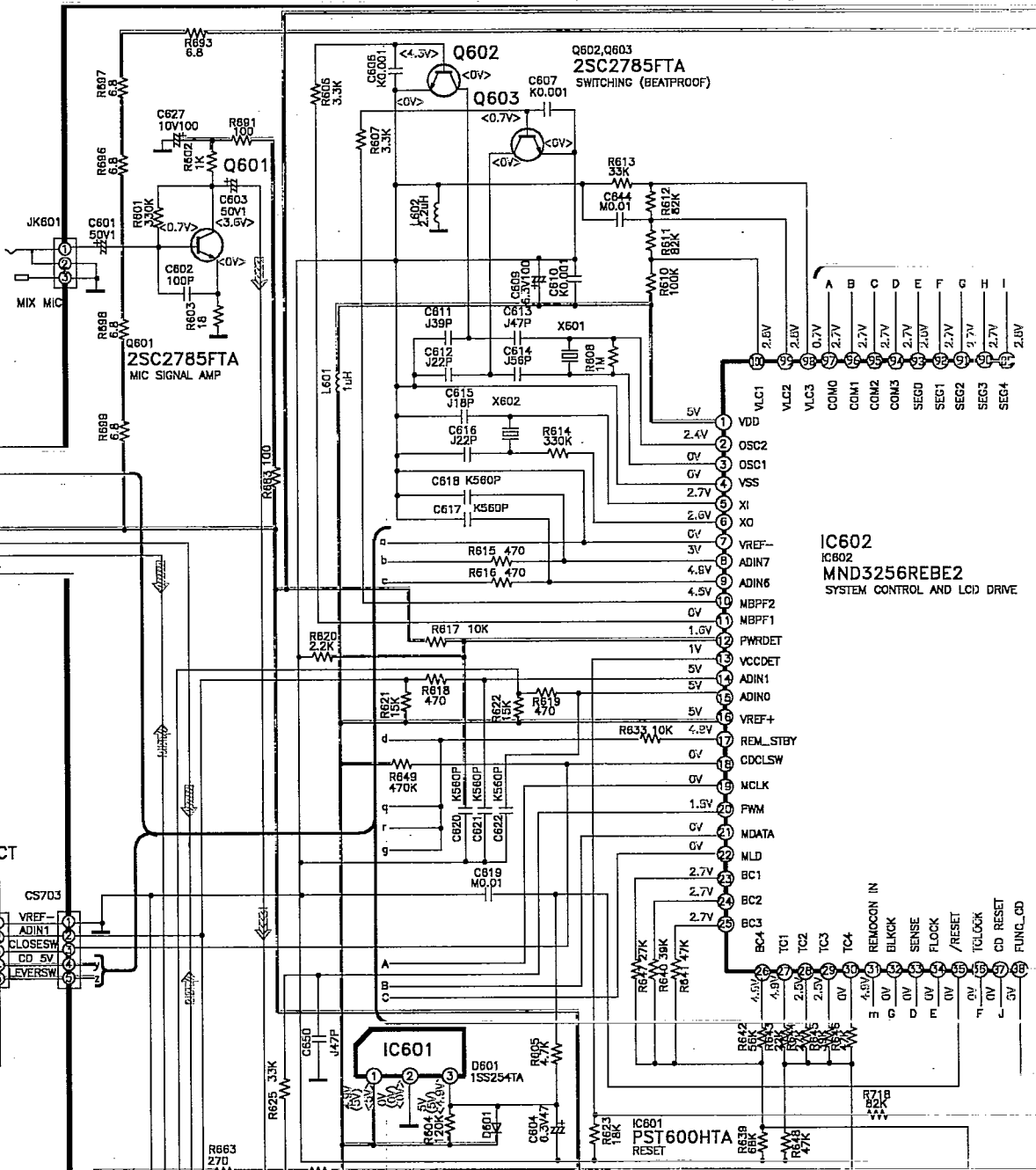
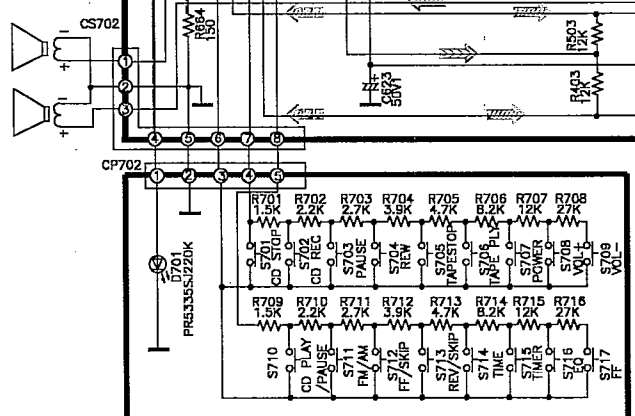

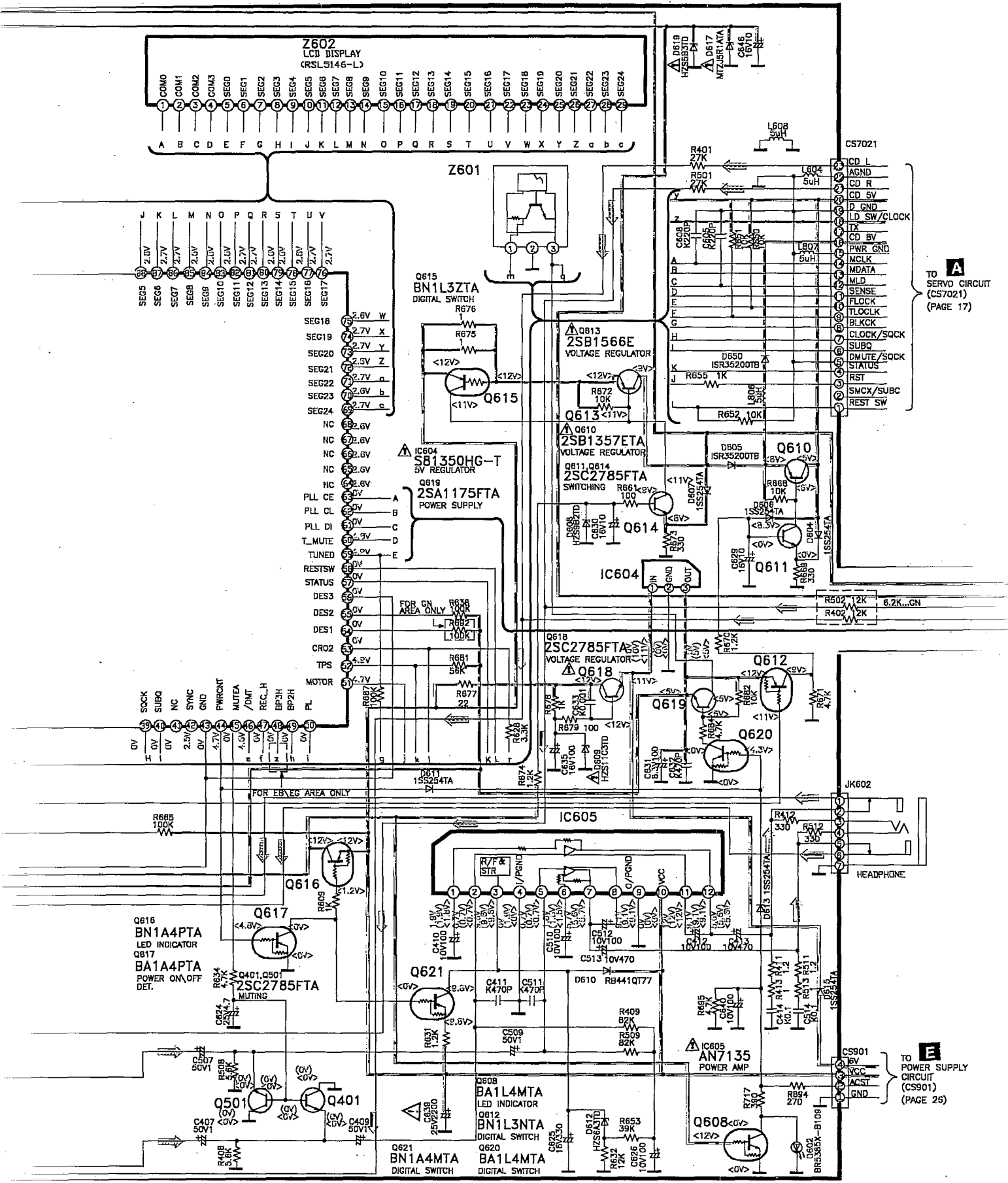

TO SERVO CIRCUIT (CS7021) (PAGE 17)

TO POWER SUPPLY CIRCUIT (CS901) (PAGE 26)

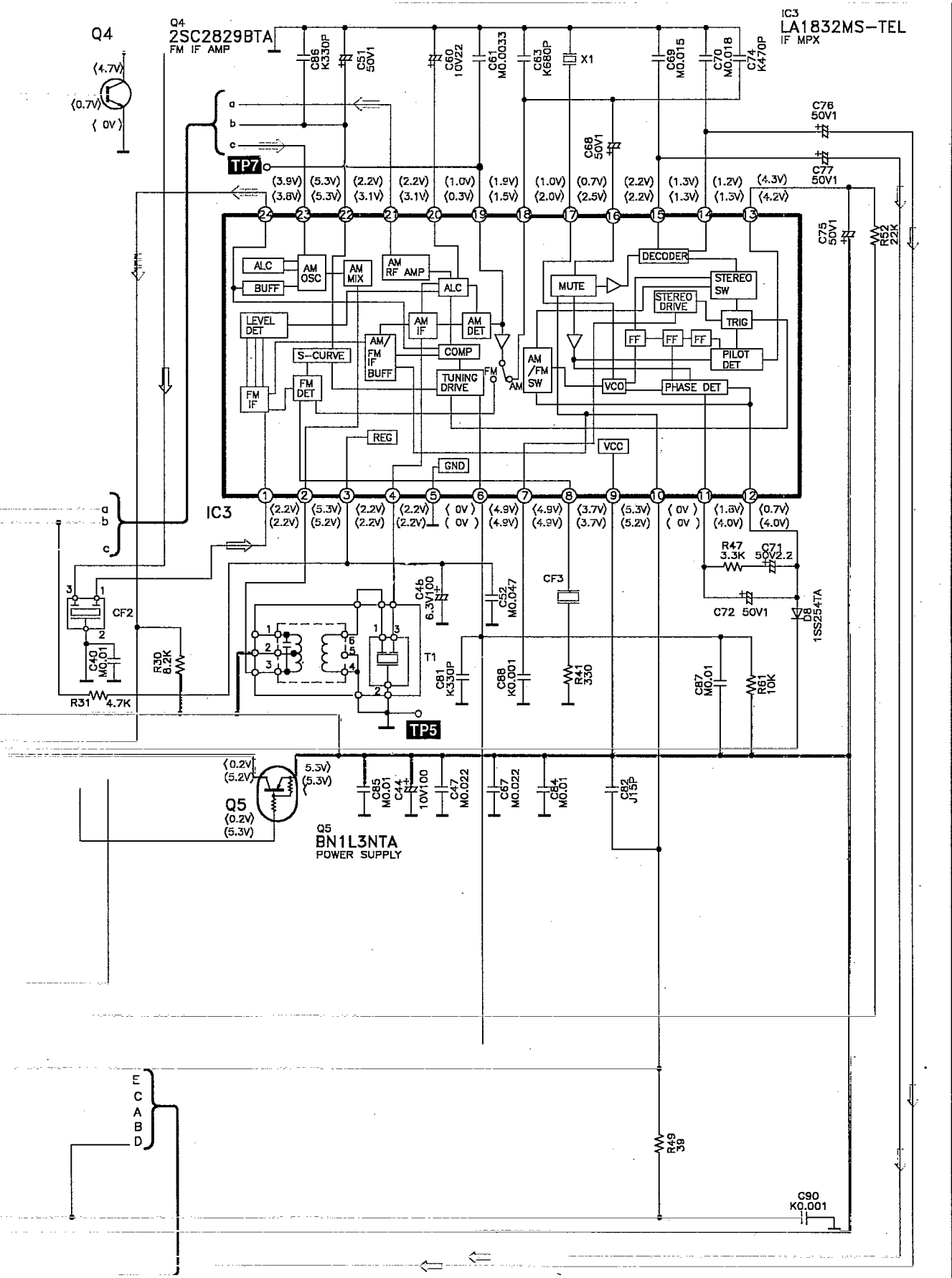

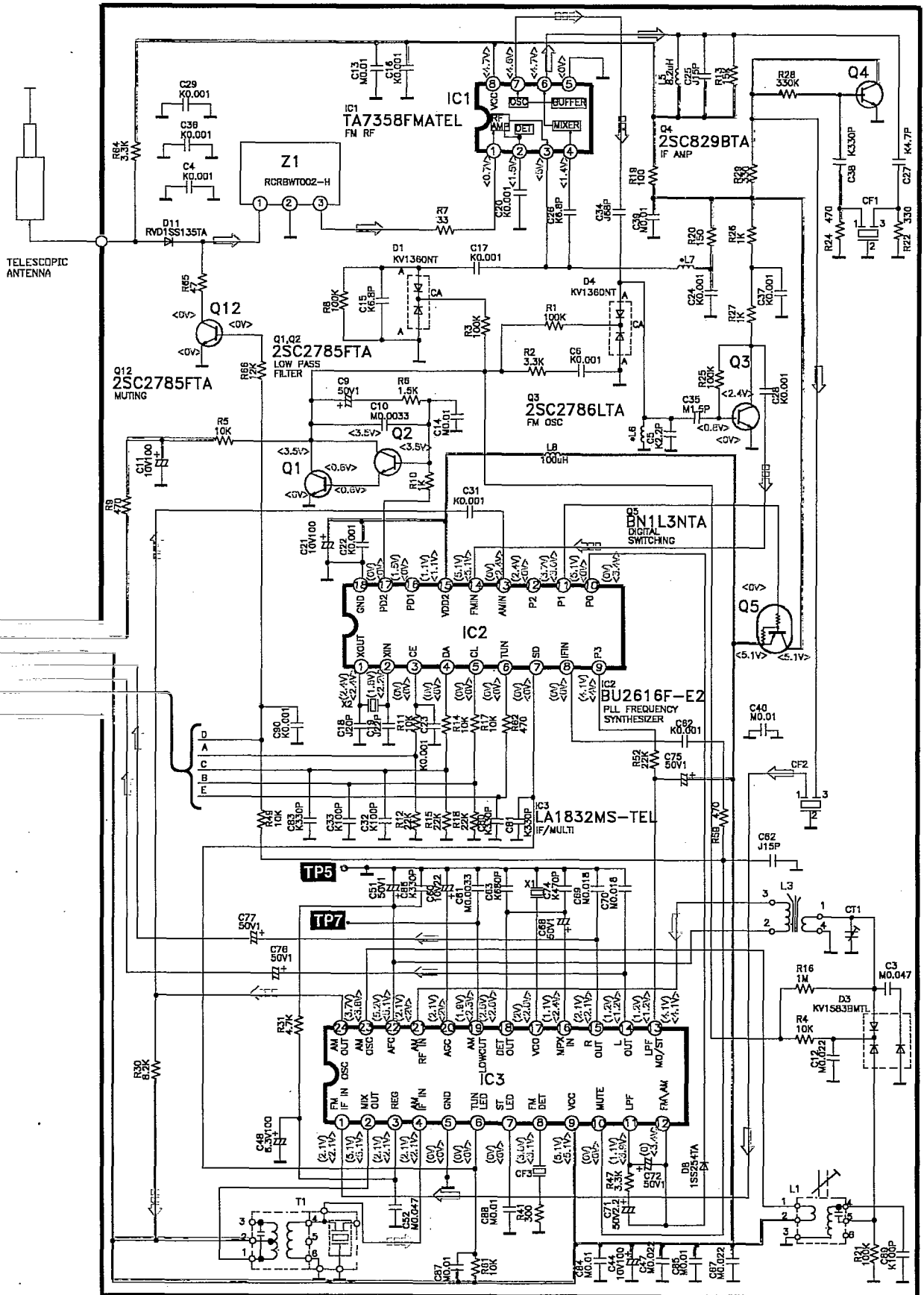

E POWER SUPPLY CIRCUIT

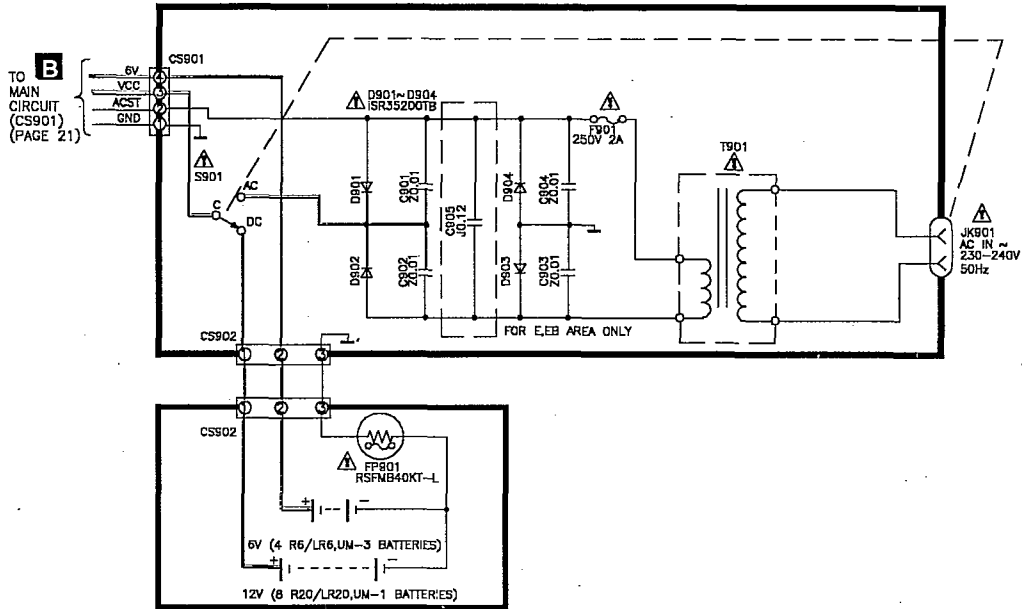

G BATTERY CIRCUIT

Printed Circuit Board

E POWER SUPPLY P.C.B. (REP2232E ... GN) (REP2232C ... EB,EG)

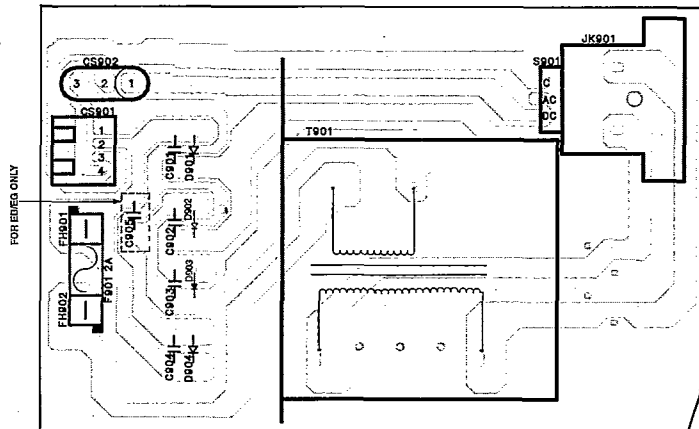

CAUTION
RISK OF ELECTRIC SHOCK
AC voltage line. Please do not
touch this pcb.

G BATTERY P.C.B. (REP2232E ... GN)
(REP2232C ... EB,EG)

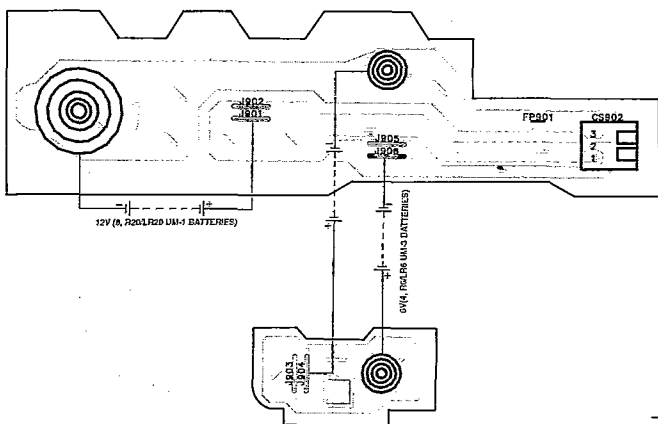

D CASSETTE EJECT P.C.B.
(REP2232E ... GN)
(REP2232C ... EB,EG)

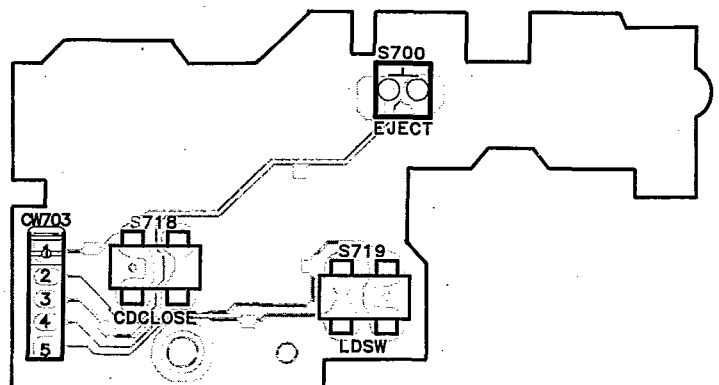

■ Replacement Parts List

Notes: * Important safety notice :
 Components identified by Δ mark have special characteristics important for safety.
 Furthermore, special parts which have purposes of fire-retardant (resistors), high-quality sound (capacitors), low-noise (resistors), etc. are used.
 When replacing any of components, be sure to use only manufacturer's specified parts shown in the parts list.
 * The parenthesized indications in the Remarks column specify the areas. (refer to the cover page for area.)
 Parts without these indications can be used for all areas.
 * [M] in Remarks column indicates parts that are supplied by MESA.
 * **Warning:** This product uses a laser diode. Refer to caution statements on page 2 and 3.
 * **ACHTUNG:** Die lasereinheit nicht zerlegen.
 Die lasereinheit darf nur gegen eine vom hersteller spezifizierte einheit ausgetauscht werden.

Ref No.	Part No.	Part Name & Description	Remarks	Ref No.	Part No.	Part Name & Description	Remarks	Ref No.	Part No.	Part Name & Description	Remarks
		CABINET AND CHASSIS		35-1	SHGD112	FLOATING RUBBER (A)		Q101	2SJ40CDTA	TRANSISTOR	
				35-2	SHGD113-1	FLOATING RUBBER (B)		Q102	2SJ40CDTA	TRANSISTOR	
				35-3	SNSD38	SCREW		Q103	2SC2785FTA	TRANSISTOR	
1	RGU1335-K	CASS. EJ. BUTTON	[M]	36	RMS0350	FIXED PIN B		Q104	2SC2785FTA	TRANSISTOR	
2	RKH0034-K	HANDLE	[M]	37	RMS0123-1	FIXED PIN A		Q105	2SJ40CDTA	TRANSISTOR	
3	RKK347ZA-K	BATTERY COVER	[M]	38	RME0109	FLOATING SPRING A		Q201	2SJ40CDTA	TRANSISTOR	
4	RMR0957-W	SAFETY COVER	[M]	39	RME0142	FLOATING SPRING B		Q202	2SJ40CDTA	TRANSISTOR	
5	RFKXGES50GCK	FRONT CABINET ASS'Y	[M](GN)	40	RMR0698-K	TRAVERSE CHASSIS		Q203	2SC2785FTA	TRANSISTOR	
5	RFKXGES50EBK	FRONT CABINET ASS'Y	[M](EB,EG)	41	XTV2+6G	SCREW		Q204	2SC2785FTA	TRANSISTOR	
5-1	RGP0519B-Q	LCD PANEL	[M]	42	XTN2+6G	SCREW		Q205	2SJ40CDTA	TRANSISTOR	
6	XTV3+12G-M	SCREW (PCB & SP)	[M]			INTEGRATED CIRCUITS		Q301	2SC1845FTA	TRANSISTOR	
7	XTV3+20G	REAR CAB SCREW						Q302	2SC1845FTA	TRANSISTOR	
8	RMN0363A	LCD HOLDER	[M]					Q303	2SD467CTZ	TRANSISTOR	[M]
9	RMV0172	HEAT SINK	[M]	IC1	TA7358FMATEL	IC,FM RF		Q304	BA1L3MTA	TRANSISTOR	[M]
10	XTV3+10F	SCREW (HEAT SINK)		IC2	BU2616F-E2	IC,PLL	[M]	Q305	2SC2785FTA	TRANSISTOR	
11	EAS8P342A6	SPEAKER	[M]	IC3	LA1832MS-TEL	IC,IF/MULTI IC		Q306	2SC2785FTA	TRANSISTOR	
12	RGU1336A-K	OPERATION BUTTON	[M]	IC301	BA7755A	IC,SW		Q307	2SC2785FTA	TRANSISTOR	
13	RHD30044	SP CONNECTOR SCREW		IC302	TA8142AP	IC,PB/REC PRE-AMP		Q308	2SC2785FTA	TRANSISTOR	
14	XTBS26+10J	SCREW		IC303	BA4558FE2	IC,LOW PASS FILTER	[M]	Q309	2SC2785FTA	TRANSISTOR	
16	XEARR210C-Y	R.ANTENNA	[M]	IC601	PST600HTA	IC,RESET		Q310	BA1A4MTA	TRANSISTOR	[M]
18	XYN3+FBFY	R. ANTENNA SCREW		IC602	MND3256REBE2	IC,MICROCOMPUTOR	[M]	Q311	BA1L3NTA	TRANSISTOR	[M]
19	RDG0183-L	DAMPER GEAR	[M]	IC603	BH3852FSE2	IC,ASP	[M]	Q312	BA1A4MTA	TRANSISTOR	[M]
20	RGU1334-K	CD EJ. BUTTON	[M]	IC604	S81350HG-T	IC,5V REGULATOR	[M] Δ	Q313	2SC2785FTA	TRANSISTOR	
21	RKQ0191-K	TOP CAB	[M]	IC605	AN7135	IC,POWER AMP	Δ	Q317	BN1L3NTA	TRANSISTOR	[M]
22	RME0202	CASS. OPEN SPRING	[M]	IC701	AN8835SBE1	IC, SERVO AMP.		Q318	BA1L3ZTA	TRANSISTOR	[M]
23	RMLX0009-KJ	CD EJECT LEVER	[M]	IC702	MN662741RPA	IC, DIGITAL LSI		Q319	2SD965RTA	TRANSISTOR	
24	RFKHXES50EBK	BACK CABINET ASS'Y	[M](EB,GN)	IC703	AN8389SE1	IC, COIL/MOTOR DRIVE		Q320	2SB1030RTA	TRANSISTOR	
24	RFKHXES50EGK	BACK CABINET ASS'Y	[M](EG)	IC971	0N2180RLC	IC,HALL		Q321	BA1A4MTA	TRANSISTOR	[M]
24-1	RJC91006	BATT. TERMINAL	[M]					Q330	2SC2785FTA	TRANSISTOR	
24-2	RJR0161	ROD ANT. TERMINAL	[M]			TRANSISTORS		Q401	2SC2785FTA	TRANSISTOR	
25	RKF0470-K	CD LID	[M]					Q501	2SC2785FTA	TRANSISTOR	
26	RME0201	CD OPEN SPRING	[M]	Q1	2SC2785FTA	TRANSISTOR		Q601	2SC2785FTA	TRANSISTOR	
28	RFKLRXES50K	CASS HOLDER ASS'Y	[M]	Q2	2SC2785FTA	TRANSISTOR		Q602	2SC2785FTA	TRANSISTOR	
28-1	RMB0448-J	CASS. EJ. LEV. SPRIN	[M]	Q3	2SC2786LTA	TRANSISTOR		Q603	2SC2785FTA	TRANSISTOR	
28-2	RUS757ZAA	CASS. HALF SPRING	[M]	Q4	2SC829BTA	TRANSISTOR		Q608	BA1L4MTA	TRANSISTOR	[M]
28-3	RMM0147	ROCK ROD		Q5	BN1L3NTA	TRANSISTOR	[M]	Q610	2SB1357ETA	TRANSISTOR	[M] Δ
29	RHM245ZA	MAGNET	[M]	Q8	2SC2785FTA	TRANSISTOR		Q611	2SC2785FTA	TRANSISTOR	
30	RMG0274-K	CLAMPER RUBBER		Q10	BN1L3NTA	TRANSISTOR	[M]	Q612	BN1L3NTA	TRANSISTOR	[M]
31	RMQ0152-E	FIXTURE	[M]	Q11	2SD1020HTA	TRANSISTOR	[M]	Q613	2SB1566E	TRANSISTOR	[M] Δ
32	RMQ0225-K	CLAMPER	[M]	Q12	2SC2785FTA	TRANSISTOR		Q614	2SC2785FTA	TRANSISTOR	
35	RAE0150Z	TRAVERSE UNIT		Q14	2SC2785FTA	TRANSISTOR		Q615	BN1L3ZTA	TRANSISTOR	[M]

RefNo.	PartNo.	PartName & Description	Remarks	RefNo.	PartNo.	PartName & Description	Remarks	RefNo.	PartNo.	PartName & Description	Remarks
Q616	BN1A4PTA	TRANSISTOR	[M]	S703	EVQ21405R	SW,REC/PAUSE		L2	RL01B004-T	COIL	
Q617	BA1A4PTA	TRANSISTOR	[M]	S704	EVQ21405R	SW,REW		L3	RLV6C013-0	AM F. ANT	(EB,EG)
Q618	2SC2785FTA	TRANSISTOR	⚠	S705	EVQ21405R	SW,TAPE STOP		L3	RLV2C022-0	AM F. ANT	(GN)
Q619	2SA1175FTA	TRANSISTOR	[M]	S706	EVQ21405R	SW,TAPE PLAY		L4	RLQZP101KT-Y	AXIAL COIL	
Q620	BA1L4MTA	TRANSISTOR	[M]	S707	EVQ21405R	SW,POWER		L5	RLQZP8R2JT-Y	AXIAL COIL	
Q621	BN1A4MTA	TRANSISTOR	[M]	S708	EVQ21405R	SW,VOL INCREASE		L8	RLQZP101KT-Y	AXIAL COIL	
Q701	2SB709S	TRANSISTOR		S709	EVQ21405R	SW,VOL DECREASE		L301	RL08B003-K	BIAS OSC COIL	
				S710	EVQ21405R	SW,CDPLAY/PAUSE		L303	RLQA470JT1-Y	AXIAL COIL	
		DIODES		S711	EVQ21405R	SW,FM/AM		L601	RLQZP100KT-Y	AXIAL COIL	
				S712	EVQ21405R	SW,FF/SKIP		L602	RLQZP2R2KT-Y	AXIAL COIL	
D1	KV1360NT	DIODE		S713	EVQ21405R	SW,REV/SKIP		L604	RLS500050T-Y	RF CHOKE COIL	
D3	KV1583BMTL	DIODE		S714	EVQ21405R	SW,TIME		L606	RLS500050T-Y	RF CHOKE COIL	
D4	KV1360NT	DIODE		S715	EVQ21405R	SW,TIMER		L607	RLS500050T-Y	RF CHOKE COIL	
D8	1SS254TA	DIODE		S716	EVQ21405R	SW,EQ		L608	RLS500050T-Y	RF CHOKE COIL	
D10	1SS254TA	DIODE		S717	EVQ21405R	SW,TAPE FF		T1	RLI2Z019-T	FM IFT	(EB,EG)
D11	RVD1SS135TA	DIODE		S718	RSH1A033-U	SW,CD OPEN/CLOSE	[M]	T1	RLI2Z010-T	FM IFT	(GN)
D95	MA165TA	DIODE		S719	RSH1A033-U	SW, LEVER SW	[M]	T901	RTP1U1B004-X	POWER TRANSFORMER	[M] ⚠
D301	1SS254TA	DIODE		S901	RJJ1SE01-1H	JACK W/SW (JK901)	⚠				
D303	1SS254TA	DIODE		S971	RSH1A018-1U	SW,MODE DETECT				TRIMMERS	
D601	1SS254TA	DIODE		S972	RSH1A019-2U	SW,TAPE DETECT					
D602	BR5385X-B109	DIODE	[M]	S973	RSH1A019-2U	SW,C02 DETECT		CT1	RCV10AF1T-S	TRIMMER	
D604	1SS254TA	DIODE		S974	RSH1A019-2U	SW,REC DETECT		CT2	ECRLA030E53R	TRIMMER CAPACITOR	
D605	1SR35200TB	DIODE		S975	RSH1A019-2U	SW,REC DETECT					
D606	1SS254TA	DIODE								CERAMIC FILTERS	
D607	1SS254TA	DIODE				CONNECTORS					
D608	HZS9B2TD	DIODE	[M]					CF1	RLFFETMLA02D	FILTER	
D609	HZS11C3TD	DIODE	[M] ⚠	CN701	RJU035T016-1	16 PIN FFC CONNECTOR		CF2	RLFFETMLA02D	FILTER	
D610	RB441QT77	DIODE		CN702	RJS1A6723-1Q	23 PIN FFC CONNECTOR		CF3	RLFDFT14AD	FM RESONATOR	
D611	1SS254TA	DIODE		CP301	RJS1A6805-J	CONNECTOR (5 P)	[M]				
D612	HZS6A3TD	DIODE	[M]	CP702	RJT029W005-1	CONNECTOR (5 P)	[M]			OSCILLATORS	
D613	1SS254TA	DIODE		CP902	RJT071H09A	CONNECTOR (9 P)					
D615	1SS254TA	DIODE		CS702	RJT060B08	SP PLUG (8P)		X1	RSXZ456KM01	19KHZ OSC	
D617	HZS5B3TD	DIODE	[M]	CS703	RJST6ZA	CONNECTOR (3P)	[M]	X2	RSXC7M20S04T	XTAL 7.2MHZ	
D619	HZS5B3TD	DIODE	[M]	CS901	RJT029W004-1	PLUG (4P)	[M]	X601	EF0EN6004T4	CERAMIC OSC	[M]
D650	1SR35200TB	DIODE		CS902	RJT029W003-1	BATT PLUG (3P)		X602	RSXD32K7S02	32.768KHZ X'TAL	[M]
D701	BG5385XJ220K	DIODE	[M]	CS971	RJU071H09M1	9P CONNECTOR	[M]	X701	RSXZ16M9M01T	CERAMIC OSC	
D901	1SR35200TB	DIODE	⚠	CS7021	RJS1A6823	23P FPC CONNECTOR					
D902	1SR35200TB	DIODE	⚠							FUSES	
D903	1SR35200TB	DIODE	⚠			COMP. COMBINATION					
D904	1SR35200TB	DIODE	⚠					F901	XBA2C20TB0	FUSE	⚠
D971	MA165TA	DIODE		Z1	RCRBWT002-H	OSC COIL					
				Z601	RCD12042SR	REM. CONTROL UNIT	[M]			FUSE PROTECTORS	
		SWITCHES		Z602	RSL5146-L	LCD	[M]				
								FP901	RSFMB40KT-L	FUSE PROTECTOR	⚠
S700	EVQ21405R	SW,CASS. OPEN				COILS,TRANSFORMERS					
S701	RSM0006-P	SW, RESET (SERVO)									
S701	EVQ21405R	SW,CD STOP/CLEAR		L1	RL02B011-T	COIL	(EB,EG)				
S702	EVQ21405R	SW,CD RECORD MODE		L1	RL02B012-T	COIL	(GN)				

Ref No.	Part No.	Part Name & Description	Remarks	Ref No.	Part No.	Part Name & Description	Remarks	Ref No.	Part No.	Part Name & Description	Remarks
		FUSE HOLDERS		W2	REX0778	WIRE, SPEAKER	[M]				
				W901	REX0779	WIRE, MAIN TO POWER	[M]				
FH901	RJR0169T	FUSE HOLDER	[M]	W902	REX0780	WIRE, BATTERY	[M]				
FH902	RJR0169T	FUSE HOLDER	[M]								
		JACKS									
JK601	RJD3M6ZB-C	JK, MIC									
JK602	RJJ37TK01-C	JK, HEAD PHONE									
JK901	RJJ1SE01-1H	JK, W/SW (S901)	⚠								
		WIRES									
W1	REE0667	WIRE, FFC	[M]								

■ Mechanism Parts List

Ref No.	Part No.	Part Name & Description	Remarks	Ref No.	Part No.	Part Name & Description	Remarks	Ref No.	Part No.	Part Name & Description	Remarks
		CASSETTE DECK		129	RMK0283	PLATE					
				130	RXL0124	PINCH ROLLER ASS'Y					
101	RED0037	HEAD BLOCK ASS'Y		130-1	RMB0401	SPRING					
103	RDG0300	REEL TABLE BASE		131	RXL0125	PINCH ROLLER ASS'Y					
104	RDG0301	GEAR		131-1	RMB0402	SPRING					
105	RDK0026	GEAR		132	RXL0126	GEAR					
107	RDV0033-1	BELT		133	RXQ0412	ROD					
108	RDV0034	BELT		133-1	RMB0405	SPRING					
110	RMB0312	SPRING		133-2	RMM0132	ROD					
111	RMB0400	REEL TABLE SPRING		134	RFKPXES50GCK	MOTOR ASS'Y	[M]				
112	RMB0403	SPRING		135	RHD26022	SCREW					
113	RMB0404	SPRING		136	XTW2+5L	SCREW					
114	RMB0406	SPRING		137	XTW26+10S	SCREW					
115	RMB0408	SPRING		138	XYC2+JF17	SCREW					
116	RML0370	LEVER									
117	RML0371	LEVER									
118	RML0372	ARM									
119	RML0374	LEVER									
120	RMM0131	LEVER									
121	RMM0133	LEVER									
122	RMQ0519	REEL TABLE HEAD									
123	RMS0398-1	SHAFT									
124	RSJ0003	PLUNGER									
125	RUS609ZC	SPRING									
126	RXF0049	FLYWHEEL ASS'Y									
127	RXF0050	FLYWHEEL ASS'Y									
128	RXG0040	GEAR									

Mechanism Parts Location (RAA4105)

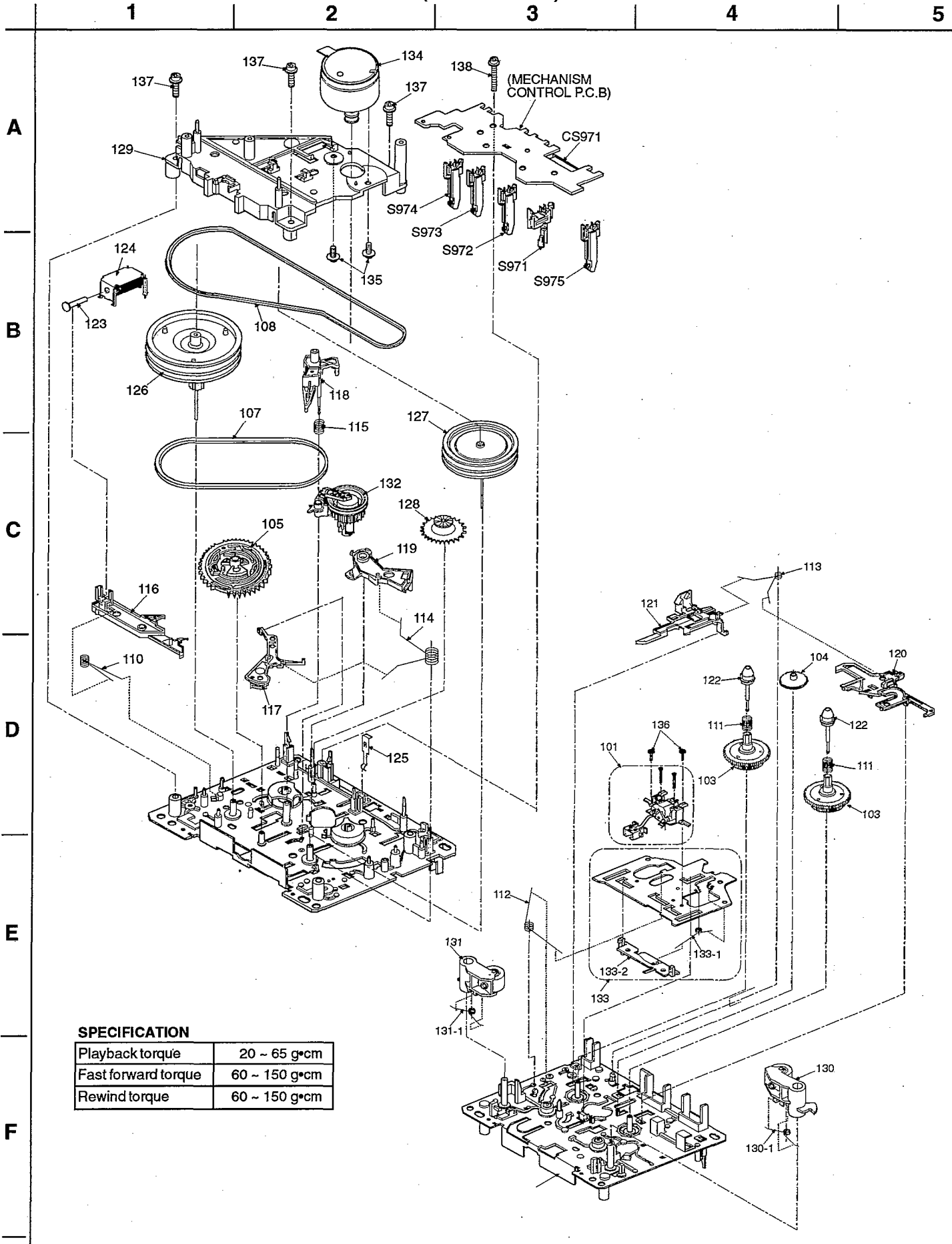

SPECIFICATION

Playback torque	20 ~ 65 g•cm
Fast forward torque	60 ~ 150 g•cm
Rewind torque	60 ~ 150 g•cm

■ Packing Materials & Accessories

Notes: * Important safety notice :
 Components identified by Δ mark have special characteristics important for safety.
 Furthermore, special parts which have purposes of fire-retardant (resistors), high-quality sound (capacitors), low-noise (resistors), etc. are used.
 When replacing any of components, be sure to use only manufacturer's specified parts shown in the parts list.
 * The parenthesized indications in the Remarks column specify the areas. (refer to the cover page for area.)
 Parts without these indications can be used for all areas.
 * [M] indicates in Remarks column parts that are supplied by MESA.
 * The "(SF)" mark denotes the standard part.
 * Remote Control Unit :
 Supply period for three years from terminal of production.

Ref.No.	Part.No.	Part Name & Description	Remarks	Ref.No.	Part.No.	Part Name & Description	Remarks	Ref.No.	Part.No.	Part Name & Description	Remarks
		PACKING MATERIALS				ACCESSORIES		A3	VJA0733	AC-CORD Δ	(EB) (SF)
								A3	RJA0019-2K	AC CORD Δ	(EG) (SF)
								A3	RJA0035-K	AC CORD Δ	(GN) (SF)
P1	RPG2843	GIFT BOX	[M](EB)(EG)	A1	RQT3458-B	INSTRUCTION MANUAL	[M](EB)(GN)				
P1	RPG2848	GIFT BOX	[M](GN)	A1	RFKSXES50EGK	INSTRUMNL ASS'Y	[M](EG)				
P2	RPH0131	MIRAMAT SHEET	[M]	A2	EUR643823	REMOTE CONTROL	[M]				
P3	RPN0943	POLYFOAM	[M]	A2-1	UR64EC1638-1	BATTERY COVER (R C)	[M]				

■ Resistors & Capacitors

Notes : * Important safety notice:
 Components identified by Δ mark have special characteristics important for safety.
 Furthermore, special parts which have purposes of fire-retardant (resistors), high-quality sound (capacitors), low-noise (resistors), etc. are used.
 When replacing any of components, be sure to use only manufacturer's specified parts shown in the parts list.
 * The parenthesized indications in the Remarks column specify the areas. (refer to the cover page for area.)
 Parts without these indications can be used for all areas.
 * Capacitor values are in microfarad (μ F) unless specified otherwise, P=Pico-farads (pF) F=Farads (F)
 * Resistors values are in ohms, unless specified otherwise, 1k=1,000(OHM), 1M=1,000k(OHM)

Ref.No.	Part.No.	Values & Remarks	Ref.No.	Part.No.	Values & Remarks	Ref.No.	Part.No.	Values & Remarks	Ref.No.	Part.No.	Values & Remarks
			R20	ERDS2TJ151T	150 1/4W	R57	ERDS2TJ103T	10K 1/4W	R116	ERDS2TJ152T	1.5K 1/4W
	RESISTORS		R21	ERDS2TJ104T	100K 1/4W (GN)	R59	ERDS2TJ471T	470 1/4W	R201	ERDS2TJ474T	470K 1/4W
			R22	ERDS2TJ331T	330 1/4W	R61	ERDS2TJ103T	10K 1/4W	R202	ERDS2TJ153T	15K 1/4W
R1	ERDS2TJ104T	100K 1/4W	R24	ERDS2TJ471T	470 1/4W	R62	ERDS2TJ471T	470 1/4W	R203	ERDS2TJ560T	56 1/4W
R2	ERDS2TJ332T	3.3K 1/4W	R25	ERDS2TJ104T	100K 1/4W	R63	ERDS2TJ105T	1M 1/4W	R204	ERDS2TJ681T	680 1/4W
R3	ERDS2TJ104T	100K 1/4W	R26	ERDS2TJ102T	1K 1/4W	R64	ERDS2TJ332T	3.3K 1/4W	R205	ERDS2TJ103T	10K 1/4W
R4	ERDS2TJ103T	10K 1/4W (GN)	R27	ERDS2TJ102T	1K 1/4W	R65	ERDS2TJ470T	47 1/4W	R206	ERDS2TJ272T	2.7K 1/4W
R5	ERDS2TJ103T	10K 1/4W	R28	ERDS2TJ334T	330K 1/4W	R66	ERDS2TJ123T	12K 1/4W	R207	ERDS2TJ334T	330K 1/4W
R6	ERDS2TJ152T	1.5K 1/4W	R29	ERDS2TJ331T	330 1/4W	R101	ERDS2TJ474T	470K 1/4W	R209	ERDS2TJ223T	22K 1/4W
R7	ERDS2TJ330T	33 1/4W	R30	ERDS2TJ822T	8.2K 1/4W	R102	ERDS2TJ153T	15K 1/4W	R210	ERDS2TJ102T	1K 1/4W
R8	ERDS2TJ104T	100K 1/4W	R31	ERDS2TJ472T	4.7K 1/4W	R103	ERDS2TJ560T	56 1/4W	R211	ERDS2TJ272T	2.7K 1/4W
R9	ERDS2TJ471T	470 1/4W	R36	ERDS2TJ223T	22K 1/4W	R104	ERDS2TJ681T	680 1/4W	R212	ERDS2TJ470T	47 1/4W
R10	ERDS2TJ102T	1K 1/4W	R37	ERDS2TJ223T	22K 1/4W	R105	ERDS2TJ103T	10K 1/4W	R213	ERDS2TJ392T	3.9K 1/4W
R11	ERDS2TJ103T	10K 1/4W	R40	ERDS2TJ105T	1M 1/4W	R106	ERDS2TJ272T	2.7K 1/4W	R214	ERDS2TJ472T	4.7K 1/4W
R12	ERDS2TJ223T	22K 1/4W	R41	ERDS2TJ301T	300 1/4W	R107	ERDS2TJ334T	330K 1/4W	R215	ERDS2TJ333T	33K 1/4W
R13	ERDS2TJ153T	15K 1/4W	R42	ERDS2TJ103T	10K 1/4W	R109	ERDS2TJ223T	22K 1/4W	R216	ERDS2TJ152T	1.5K 1/4W
R14	ERDS2TJ103T	10K 1/4W	R43	ERDS2TJ222T	2.2K 1/4W	R110	ERDS2TJ102T	1K 1/4W	R301	ERDS2TJ474T	470K 1/4W
R15	ERDS2TJ223T	22K 1/4W	R44	ERDS2TJ222T	2.2K 1/4W	R111	ERDS2TJ272T	2.7K 1/4W	R302	ERDS2TJ104T	100K 1/4W
R16	ERDS2TJ105T	1M 1/4W (GN)	R47	ERDS2TJ332T	3.3K 1/4W	R112	ERDS2TJ470T	47 1/4W	R303	ERDS2TJ103T	10K 1/4W
R17	ERDS2TJ103T	10K 1/4W	R49	ERDS2TJ103T	10K 1/4W	R113	ERDS2TJ392T	3.9K 1/4W	R304	ERDS2TJ152T	1.5K 1/4W
R18	ERDS2TJ223T	22K 1/4W	R52	ERDS2TJ223T	22K 1/4W	R114	ERDS2TJ472T	4.7K 1/4W	R305	ERDS2TJ152T	1.5K 1/4W
R19	ERDS2TJ101T	100 1/4W	R54	ERDS2TJ222T	2.2K 1/4W	R115	ERDS2TJ333T	33K 1/4W	R306	ERDS2TJ152T	1.5K 1/4W

RefNo.	PartNo.	Values & Remarks	RefNo.	PartNo.	Values & Remarks	RefNo.	PartNo.	Values & Remarks	RefNo.	PartNo.	Values & Remarks
R307	ERDS2TJ153T	15K 1/4W	R412	ERDS2TJ331T	330 1/4W	R642	ERDS2TJ563T	56K 1/4W	R704	ERDS2TJ392T	3.9K 1/4W
R308	ERDS2TJ153T	15K 1/4W	R413	ERDS2TJ1R0T	1 1/4W	R643	ERDS2TJ223T	22K 1/4W	R705	ERDS2TJ472T	4.7K 1/4W
R309	ERDS2TJ331T	330 1/4W	R501	ERDS2TJ273T	27K 1/4W	R644	ERDS2TJ273T	27K 1/4W	R706	ERDS2TJ822T	8.2K 1/4W
R310	ERDS2TJ103T	10K 1/4W	R502	ERDS2TJ123T	12K 1/4W(EB,EG)	R645	ERDS2TJ393T	39K 1/4W	R707	ERDS2TJ123T	12K 1/4W
R311	ERD2FCVJ4R7T	4.7 1/4W	R502	ERDS2TJ822T	8.2K 1/4W (GN)	R646	ERDS2TJ473T	47K 1/4W	R708	ERDS2TJ273T	27K 1/4W
R312	ERDS2TJ752T	7.5K 1/4W	R503	ERDS2TJ123T	12K 1/4W	R647	ERDS2TJ273T	27K 1/4W	R709	ERDS2TJ152T	1.5K 1/4W
R313	ERDS2TJ472T	4.7K 1/4W	R504	ERDS2TJ472T	4.7K 1/4W	R648	ERDS2TJ473T	47K 1/4W	R710	ERDS2TJ222T	2.2K 1/4W
R314	ERDS2TJ153T	15K 1/4W	R505	ERDS2TJ222T	2.2K 1/4W	R649	ERDS2TJ474T	470K 1/4W	R711	ERDS2TJ272T	2.7K 1/4W
R315	ERDS2TJ472T	4.7K 1/4W	R507	ERDS2TJ223T	22K 1/4W	R650	ERDS2TJ103T	10K 1/4W	R712	ERDS2TJ392T	3.9K 1/4W
R316	ERDS2TJ470T	47 1/4W	R508	ERDS2TJ562T	5.6K 1/4W	R651	ERDS2TJ103T	10K 1/4W	R713	ERDS2TJ472T	4.7K 1/4W
R317	ERDS2TJ472T	4.7K 1/4W	R509	ERDS2TJ823T	82K 1/4W	R652	ERDS2TJ103T	10K 1/4W	R714	ERDS2TJ822T	8.2K 1/4W
R318	ERDS2TJ682T	6.8K 1/4W	R511	ERDS2TJ1R2T	1.2 1/4W	R653	ERDS2TJ393T	39K 1/4W	R715	ERDS2TJ123T	12K 1/4W
R319	ERDS2TJ823T	82K 1/4W	R512	ERDS2TJ331T	330 1/4W	R655	ERDS2TJ102T	1K 1/4W	R716	ERDS2TJ273T	27K 1/4W
R320	ERDS2TJ103T	10K 1/4W	R513	ERDS2TJ1R0T	1 1/4W	R661	ERDS2TJ101T	100 1/4W	R717	ERDS2TJ391T	390 1/4W
R321	ERDS2TJ103T	10K 1/4W	R601	ERDS2TJ334T	330K 1/4W	R662	ERDS2TJ271T	270 1/4W	R718	ERDS2TJ823T	82K 1/4W
R322	ERDS2TJ102T	1K 1/4W	R602	ERDS2TJ102T	1K 1/4W	R663	ERDS2TJ271T	270 1/4W	R972	ERDS2TJ821T	820 1/4W
R323	ERDS2TJ393T	39K 1/4W	R603	ERDS2TJ180T	18 1/4W	R664	ERDS2TJ151T	150 1/4W	R972	ERDS2TJ821T	820 1/4W
R324	ERDS2TJ822T	8.2K 1/4W	R604	ERDS2TJ124T	120K 1/4W	R665	ERDS2TJ104T	100K 1/4W	R973	ERDS2TJ393T	39K 1/4W
R325	ERDS2TJ562T	5.6K 1/4W	R605	ERDS2TJ472T	4.7K 1/4W	R668	ERDS2TJ103T	10K 1/4W	R973	ERDS2TJ393T	39K 1/4W
R326	ERDS2TJ682T	6.8K 1/4W	R606	ERDS2TJ332T	3.3K 1/4W	R669	ERDS2TJ331T	330 1/4W			
R327	ERDS2TJ102T	1K 1/4W	R607	ERDS2TJ332T	3.3K 1/4W	R670	ERDS2TJ122T	1.2K 1/4W			
R328	ERDS2TJ101T	100 1/4W	R608	ERDS2TJ105T	1M 1/4W	R671	ERDS2TJ472T	4.7K 1/4W			
R329	ERDS2TJ335T	3.3M 1/4W	R609	ERDS2TJ102T	1K 1/4W	R672	ERDS2TJ103T	10K 1/4W			
R330	ERDS2TJ823T	82K 1/4W	R610	ERDS2TJ104T	100K 1/4W	R673	ERDS2TJ331T	330 1/4W	C3	ECFR1C473MR	0.047 16V (GN)
R331	ERDS2TJ104T	100K 1/4W	R611	ERDS2TJ823T	82K 1/4W	R674	ERDS2TJ122T	1.2K 1/4W	C4	RCBS1H102KBY	1000P 50V
R332	ERDS2TJ333T	33K 1/4W	R612	ERDS2TJ823T	82K 1/4W	R675	ERDS2TJ1R0T	1 1/4W	C5	ECBT1H2R2KC5	2.2P 50V
R333	ERDS2TJ472T	4.7K 1/4W	R613	ERDS2TJ333T	33K 1/4W	R676	ERDS2TJ1R0T	1 1/4W	C6	RCBS1H102KBY	1000P 50V
R334	ERDS2TJ393T	39K 1/4W	R614	ERDS2TJ334T	330K 1/4W	R677	ERD2FCVJ4R7T	22 1/4W	C9	ECEA1HK010B	1 50V
R335	ERDS2TJ682T	6.8K 1/4W	R615	ERDS2TJ471T	470 1/4W	R678	ERDS2TJ102T	1K 1/4W	C10	ECBT1C332MR5	3300P 16V
R336	ERDS2TJ331T	330 1/4W	R616	ERDS2TJ471T	470 1/4W	R679	ERDS2TJ101T	100 1/4W	C11	ECEA1AKA101B	100 10V
R337	ERDS2TJ273T	27K 1/4W	R617	ERDS2TJ103T	10K 1/4W	R680	ERDS2TJ222T	2.2K 1/4W	C12	ECFR1C473MR	0.047 16V(EB,EG)
R338	ERDS2TJ102T	1K 1/4W	R618	ERDS2TJ471T	470 1/4W	R681	ERDS2TJ563T	56K 1/4W	C12	ECFR1C223MR	0.022 16V (GN)
R339	ERDS2TJ473T	47K 1/4W	R619	ERDS2TJ471T	470 1/4W	R682	ERDS2TJ103T	10K 1/4W	C13	ECFR1C103MR	0.01 16V
R340	ERDS2TJ223T	22K 1/4W	R620	ERDS2TJ222T	2.2K 1/4W	R683	ERDS2TJ101T	100 1/4W	C14	ECBT1C103MS5	0.01 16V
R341	ERDS2TJ471T	470 1/4W	R621	ERDS2TJ153T	15K 1/4W	R684	ERDS2TJ472T	4.7K 1/4W	C15	ECBT1H5R6KC5	5.6P 50V
R342	ERDS2TJ153T	15K 1/4W	R622	ERDS2TJ153T	15K 1/4W	R687	ERDS2TJ104T	100K 1/4W	C16	RCBS1H102KBY	1000P 50V
R351	ERDS2TJ473T	47K 1/4W	R623	ERDS2TJ183T	18K 1/4W	R691	ERDS2TJ101T	100 1/4W	C17	RCBS1H102KBY	1000P 50V
R352	ERDS2TJ473T	47K 1/4W	R625	ERDS2TJ333T	33K 1/4W	R692	ERDS2TJ104T	100K 1/4W (GN)	C18	ECBT1H200JC5	20P 50V
R401	ERDS2TJ273T	27K 1/4W	R626	ERDS2TJ104T	100K 1/4W (GN)	R693	ERDS2TJ6R8T	6.8 1/4W	C19	ECBT1H220JC5	22P 50V
R402	ERDS2TJ123T	12K 1/4W(EB,EG)	R628	ERDS2TJ332T	3.3K 1/4W	R694	ERDS2TJ271T	270 1/4W	C20	RCBS1H102KBY	1000P 50V
R402	ERDS2TJ822T	8.2K 1/4W (GN)	R631	ERDS2TJ122T	1.2K 1/4W	R695	ERDS2TJ472T	4.7K 1/4W	C21	ECEA1AKA101B	100 10V
R403	ERDS2TJ123T	12K 1/4W	R632	ERDS2TJ123T	12K 1/4W	R696	ERDS2TJ6R8T	6.8 1/4W	C22	RCBS1H102KBY	1000P 50V
R404	ERDS2TJ472T	4.7K 1/4W	R633	ERDS2TJ103T	10K 1/4W	R697	ERDS2TJ6R8T	6.8 1/4W	C23	RCBS1H102KBY	1000P 50V
R405	ERDS2TJ222T	2.2K 1/4W	R634	ERDS2TJ472T	4.7K 1/4W	R698	ERDS2TJ6R8T	6.8 1/4W	C24	RCBS1H102KBY	1000P 50V
R407	ERDS2TJ223T	22K 1/4W	R638	ERDS2TJ104T	100K 1/4W	R699	ERDS2TJ6R8T	6.8 1/4W	C25	ECBT1H150JC5	15P 50V
R408	ERDS2TJ562T	5.6K 1/4W	R639	ERDS2TJ683T	68K 1/4W	R701	ERDS2TJ152T	1.5K 1/4W	C26	ECBT1H6R8KC5	6.8P 50V
R409	ERDS2TJ823T	82K 1/4W	R640	ERDS2TJ393T	39K 1/4W	R702	ERDS2TJ222T	2.2K 1/4W	C27	ECBT1H4R7KC5	4.7P 50V
R411	ERDS2TJ1R2T	1.2 1/4W	R641	ERDS2TJ473T	47K 1/4W	R703	ERDS2TJ272T	2.7K 1/4W	C28	RCBS1H102KBY	1000P 50V
									C29	RCBS1H102KBY	1000P 50V

RefNo	PartNo.	Values & Remarks	RefNo.	Part No.	Values & Remarks	RefNo.	PartNo.	Values & Remarks	RefNo.	PartNo.	Values & Remarks
C31	RCBS1H102KBY	1000P 50V	C104	ECBT1H331KB5	330P 50V	C401	ECBT1H221KB5	220P 50V	C623	ECEA1HKA010B	1 50V
C32	ECBT1H101KB5	100P 50V	C105	ECFR1C153KR	0.015 16V	C402	ECEA1CKA100B	10 16V	C624	ECEA1EKA4R7B	4.7 25V
C33	ECBT1H101KB5	100P 50V	C106	ECEA1EKA4R7B	4.7 25V	C403	ECEA1CKA100B	10 16V	C625	ECEA1CU331B	330 16V
C34	ECBT1H680J5	68P 50V	C107	ECEA1HKA010B	1 50V	C404	ECFR1C473KR	0.047 16V	C626	ECEA1AU101B	100 10V
C35	ECBT1H1R5M5	1.5P 50V	C108	ECEA1AU470B	47 10V	C405	ECFR1C683KR	0.068 16V	C627	ECEA1AU101B	100 10V
C36	RCBS1H102KBY	1000P 50V	C111	ECEA1EKA4R7B	4.7 25V	C406	ECBT0J223MS5	0.022 6.3V	C628	RCBS1H102KBY	1000P 50V
C37	RCBS1H102KBY	1000P 50V	C112	ECBT1H821KB5	820P 50V	C407	ECEA1HKA010B	1 50V	C629	ECEA1CKA100B	10 16V
C38	ECBT1H331KB5	330P 50V	C113	ECBT1H102KB5	1000P 50V	C409	ECEA1HKA010B	1 50V	C630	ECEA1CU100B	10 16V
C39	ECBT1C103MS5	0.01 16V	C114	ECBT1H102KB5	1000P 50V	C410	ECEA1AKA101B	100 10V	C631	ECEA0JU101B	100 6.3V
C40	ECBT1C103MS5	0.01 16V	C115	ECBT1H101KB5	100P 50V	C411	ECBT1H471KB5	470P 50V	C632	ECBT1H471KB5	470P 50V
C44	ECEA1AU101B	100 10V	C201	ECBT1H101KB5	100P 50V	C412	ECEA1AKA101B	100 10V	C633	ECBT1H102KB5	1000P 50V
C47	ECFR1C223MR	0.022 16V	C202	ECBT1C152KR5	1500P 16V	C413	ECEA1AU471B	470 10V	C635	ECEA1CU101B	100 16V
C48	ECEA0JU101B	100 6.3V	C203	ECEA0JKA470B	47 6.3V	C414	ECFR1C104KR	0.1 16V	C639	ECEA1EU222B	2200 25V 
C51	ECEA1HKA010B	1 50V	C204	ECBT1H331KB5	330P 50V	C501	ECBT1H221KB5	220P 50V	C640	ECEA1AU101B	100 10V
C52	ECFR1C473MR	0.047 16V	C205	ECFR1C153KR	0.015 16V	C502	ECEA1CKA100B	10 16V	C644	ECBT1C103MS5	0.01 16V
C58	ECBT1H8R2KC5	8.2P 50V	C206	ECEA1EKA4R7B	4.7 25V	C503	ECEA1CKA100B	10 16V	C646	ECEA1CKA100B	10 16V
C60	ECEA1AKA220B	22 10V	C207	ECEA1HKA010B	1 50V	C504	ECFR1C473KR	0.047 16V	C647	ECEA1CKA100B	10 16V
C61	ECBT1C332MR5	3300P 16V	C208	ECEA1AU470B	47 10V	C505	ECFR1C683KR	0.068 16V	C648	ECEA1EKA4R7B	4.7 25V
C62	RCBS1H102KBY	1000P 50V	C211	ECEA1EKA4R7B	4.7 25V	C506	ECBT0J223MS5	0.022 6.3V	C649	ECEA1CKA100B	10 16V
C63	ECBT1H681KB5	680P 50V	C212	ECBT1H821KB5	820P 50V	C507	ECEA1HKA010B	1 50V	C650	ECBT1H470J5	47P 50V
C64	ECFR1C473MR	0.047 16V	C213	ECBT1H102KB5	1000P 50V	C509	ECEA1HKA010B	1 50V	C651	ECEA1AU101B	100 10V
C65	ECBT1H470J5	47P 50V	C214	ECBT1H102KB5	1000P 50V	C510	ECEA1AKA101B	100 10V	C653	ECEA1AU101B	100 10V
C66	ECBT1H100JC5	10P 50V	C215	ECBT1H101KB5	100P 50V	C511	ECBT1H471KB5	470P 50V	C901	ECKR1H103ZF5	0.01 50V
C67	ECFR1C223MR	0.022 16V	C301	ECEA1HN10SB	1 50V	C512	ECEA1AKA101B	100 10V	C902	ECKR1H103ZF5	0.01 50V
C68	ECEA1HKA010B	1 50V	C302	ECBT1C103MS5	0.01 16V	C513	ECEA1AU471B	470 10V	C903	ECKR1H103ZF5	0.01 50V
C69	ECFR1C183MR	0.018 16V	C303	ECBT1C103MS5	0.01 16V	C514	ECFR1C104KR	0.1 16V	C904	ECKR1H103ZF5	0.01 50V
C70	ECFR1C183MR	0.018 16V	C304	ECQP1152JZT	1500P 100V [M]	C601	ECEA1HKA010B	1 50V	C905	ECQV1H124JZ3	0.12 50V
C71	ECEA1HKA2R2B	2.2 50V	C305	ECQP1102JZT	1000P 100V	C602	ECBT1H101KB5	100P 50V			
C72	ECEA1HKA010B	1 50V	C306	ECQP2A472JZT	4700P 100V	C603	ECEA1HKA010B	1 50V		<SERVO>	
C74	ECBT1H471KB5	470P 50V	C307	ECEA1HKA010B	1 50V	C604	ECEA0JKA470B	47 6.3V		RESISTORS	
C75	ECEA1HKA010B	1 50V	C308	ECEA1AU101B	100 10V	C605	ECBT1H221KB5	220P 50V			
C76	ECEA1HKA010B	1 50V	C309	ECQV1H473JZ3	0.047 50V	C606	ECBT1H102KB5	1000P 50V	R701	ERJ6GEYJ4R7V	4.7 1/10W
C77	ECEA1HKA010B	1 50V	C310	ECBT1H102KB5	1000P 50V	C607	ECBT1H102KB5	1000P 50V	R703	ERJ6GEYJ823	82K 1/10W
C80	ECBT1H331KB5	330P 50V	C311	ECBT1H102KB5	1000P 50V	C608	ECBT1H221KB5	220P 50V	R704	ERJ6GEYJ102V	1K 1/10W
C81	ECBT1H331KB5	330P 50V	C312	ECBT1C222MR5	2200P 16V	C609	ECEA0JU101B	100 6.3V	R705	ERJ6GEYJ103V	10K 1/10W
C82	ECBT1H150JC5	15P 50V	C313	ECBT1C222MR5	2200P 16V	C610	ECBT1H102KB5	1000P 50V	R706	ERJ6GEYJ102V	1K 1/10W
C83	ECBT1H331KB5	330P 50V	C314	ECBT1C332MR5	3300P 16V	C611	ECBT1H390J5	39P 50V	R707	ERJ6GEYJ474V	470K 1/10W
C84	ECBT1C103MS5	0.01 16V	C315	ECEA1AU101B	100 10V	C612	ECBT1H220JC5	22P 50V	R708	ERJ6GEYJ154V	150K 1/10W
C85	ECBT1C103MS5	0.01 16V	C316	ECFR1C104KR	0.1 16V	C613	ECBT1H470J5	47P 50V	R709	ERJ6GEYJ683V	68K 1/10W
C86	ECBT1H331KB5	330P 50V	C317	ECBT1H470J5	47P 50V	C614	ECBT1H560J5	56P 50V	R711	ERJ6GEYJ154V	150K 1/10W
C87	ECBT1C103MS5	0.01 16V	C318	ECEA1HKA3R3B	3.3 50V	C615	ECBT1H180JC5	18P 50V	R712	ERJ6GEYJ221V	220 1/10W
C88	RCBS1H102KBY	1000P 50V (EB,EG)	C319	ECEA1AU221B	220 10V	C616	ECBT1H220JC5	22P 50V	R717	ERJ6GEYJ102V	1K 1/10W
C88	ECBT1C103MS5	0.01 16V (GN)	C320	ECEA1CKA220B	22 16V	C617	ECBT1H561KB5	560P 50V	R718	ERJ6GEYJ102V	1K 1/10W
C89	ECBT1H101KB5	100P 50V	C321	ECEA0JKA220B	22 6.3V	C618	ECBT1H561KB5	560P 50V	R719	ERJ6GEYJ102V	1K 1/10W
C90	RCBS1H102KBY	1000P 50V	C322	ECEA1AU470B	47 10V	C619	ECBT1C103MS5	0.01 16V	R720	ERJ6GEYJ102V	1K 1/10W
C101	ECBT1H101KB5	100P 50V	C323	ECBT1C103MS5	0.01 16V	C620	ECBT1H561KB5	560P 50V	R721	ERJ6GEYJ101V	100 1/10W
C102	ECBT1C152KR5	1500P 16V	C324	ECBT1C472MR5	4700P 16V	C621	ECBT1H561KB5	560P 50V	R722	ERJ6GEYJ563V	56K 1/10W
C103	ECEA0JKA470B	47 6.3V	C325	ECEA1AU101B	100 10V	C622	ECBT1H561KB5	560P 50V	R723	ERJ6GEYJ182V	1.8K 1/10W

RefNo.	PartNo.	Values & Remarks	RefNo.	PartNo.	Values & Remarks	RefNo.	PartNo.	Values & Remarks	RefNo.	PartNo.	Values & Remarks
R724	ERJ6GEYJ333V	33K 1/10W	C726	ECUV1H102KBN	1000P 50V						
R725	ERJ6GEYJ472V	4.7K 1/10W	C727	ECEA1HPK010I	1 50V		TEST JUMPERS				
R726	ERJ6GEYJ473V	47K 1/10W	C728	ECEA1HPK010I	1 50V	TJ701	EYF8CU	TEST JUMPER			
R727	ERJ6GEYJ822V	8.2K 1/10W	C730	ECUZNE104MBN	0.1 25V	TJ702	EYF8CU	TEST JUMPER			
R728	ERJ6GEYJ103V	10K 1/10W	C731	ECEA0JKA22II	220 6.3V						
R731	ERJ6GEYJ822V	8.2K 1/10W	C732	ECEA0JKA22II	220 6.3V						
R734	ERJ6GEYJ101V	100 1/10W	C733	ECUZNE104MBN	0.1 25V						
R735	ERJ6GEYJ101V	100 1/10W	C734	ECEA1AKA22II	220 10V						
R736	ERJ6GEYJ101V	100 1/10W	C735	ECUZNE104MBN	0.1 25V						
R738	ERJ6GEYJ223V	22K 1/10W	C736	ECUZNE104MBN	0.1 25V						
R741	ERJ6GEYJ562V	5.6K 1/10W	C737	ECUZNE104MBN	0.1 25V						
R742	ERJ6GEYJ562V	5.6K 1/10W	C738	ECUV1C154KBN	0.15 16V						
R743	ERJ6GEYJ562V	5.6K 1/10W	C742	ECUV1E273KBN	0.027 25V						
R744	ERJ6GEYJ103V	10K 1/10W	C743	ECUZNE104MBN	0.1 25V						
R745	ERJ6GEYJ155V	1.5M 1/10W	C744	ECUV1E822KBN	8200P 25V						
R748	ERJ6GEYJ182V	1.8K 1/10W	C745	ECUV1C473MBN	0.047 16V						
R749	ERJ6GEYJ682V	6.8K 1/10W	C747	ECUV1H222KBN	2200P 50V						
R750	ERJ6GEYJ473V	47K 1/10W	C748	ECUV1H471KBM	470P 50V						
R751	ERJ6GEYJ473V	47K 1/10W	C749	ECUZNE104MBN	0.1 25V						
R752	ERJ8GEYJ220V	22 1/8W	C751	ECUZNE104MBN	0.1 25V						
R770	ERJ6GEYJ155V	1.5M 1/10W	C752	ECUV1H152KBN	1500P 50V						
R771	ERJ6GEYJ155V	1.5M 1/10W	C753	ECUV1H471KBM	470P 50V						
R772	ERJ6GEYJ273V	27K 1/10W	C754	ECUV1H471KBN	470P 50V						
	CAPACITORS			CLIPS JUMPERS							
C701	ECEA0JKA330I	33 6.3V	RJ701	ERJ8GEY0R00A	0 1/8W						
C702	ECUZNE104MBN	0.1 25V	RJ702	ERJ8GEY0R00A	0 1/8W						
C703	ECEA0JKA101I	100 6.3V	RJ703	ERJ8GEY0R00A	0 1/8W						
C704	ECUZNE104MBN	0.1 25V	RJ704	ERJ8GEY0R00A	0 1/8W						
C705	ECUZNE104MBN	0.1 25V	RJ707	ERJ8GEY0R00A	0 1/8W						
C706	ECUV1H272KBN	2700P 50V	RJ709	ERJ8GEY0R00A	0 1/8W						
C707	ECUV1E273KBN	0.027 25V	RJ714	ERJ8GEY0R00A	0 1/8W						
C708	ECUV1H472KBN	4700P 50V	RJ715	ERJ8GEY0R00A	0 1/8W						
C709	ECUV1C473KBN	0.047 16V	RJ716	ERJ8GEY0R00A	0 1/8W						
C710	ECUV1H182KBN	1800P 50V	RJ717	ERJ8GEY0R00A	0 1/8W						
C711	ECUZNE104MBN	0.1 25V	RJ721	ERJ8GEY0R00A	0 1/8W						
C712	ECUZNE104MBN	0.1 25V	RJ722	ERJ8GEY0R00A	0 1/8W						
C713	ECUV1C104MBM	0.1 16V	RJ723	ERJ8GEY0R00A	0 1/8W						
C714	ECEA0JKA101I	100 6.3V	RJ724	ERJ8GEY0R00A	0 1/8W						
C716	ECUV1H561KBN	560P 50V	RJ725	ERJ8GEY0R00A	0 1/8W						
C717	ECUZNE104MBN	0.1 25V	RJ726	ERJ8GEY0R00A	0 1/8W						
C718	ECUV1C224KBN	0.22 16V	RJ727	ERJ8GEY0R00A	0 1/8W						
C721	ECUV1H150JCN	15P 50V	RJ728	ERJ8GEY0R00A	0 1/8W						
C722	ECUV1H150JCN	15P 50V	RJ729	ERJ8GEY0R00A	0 1/8W						
C723	ECEA1AKA22II	220 10V	RJ730	ERJ8GEY0R00A	0 1/8W						
C724	ECUV1C104MBM	0.1 16V									
C725	ECUV1H102KBN	1000P 50V									